

Better living 23

divani
e poltrone
sofas and
armchairs

Twils®

Better living 23

**divani
e poltrone**
sofas and
armchairs

Twils®

divani	Etan	11
sofas	Biggie	23
	T–Pad	45
	Harold	71
	Wing	81
	Nubes	89
	T–Time	99
	Avenue	111
	Balmoral	121
	Newport	129
	Antibes	141
	Ascot	151
poltrone	PoLet	165
armchairs	Moon	175
	Etan	183
	Rica	187
	Adele	193
	T–Vision	201
	Chocolat	209
	Jolie	217
complementi		223
furnishing		
schede tecniche		247
technical data		
cura e fattore umano		295
care and human factor		

una storia italiana an Italian story



Immaginiamoci sdraiati sull'erba, sotto le fronde di un albero. Poche situazioni regalano un piacere così intenso e autentico. Perché guardare lontano, verso il cielo, immersi in una quinta fatta di natura, è quello per cui siamo nati, anche se spesso lo dimentichiamo.

La natura è il presente ma anche il passato, è vita che si rigenera stagione dopo stagione. Un progetto di design perfetto, unione di forma, funzione e memoria, a cui ci ispiriamo ogni giorno.

Natura e design ci aiutano a immaginare un abitare migliore: che si anima sposando la leggerezza del cielo e la concretezza della terra, la flessibilità della trasformazione e il per sempre della materia lavorata con la mano esperta dell'uomo.

È da queste riflessioni che nasce la nostra proposta per un Better Living, con la direzione creativa di Matteo Ragni.

Quella di Twils è una storia molto italiana. Un'azienda radicata nel territorio, a filiera corta, che alimenta una rete di fornitori locali e si fa alimentare da loro, in un circuito virtuoso potenzialmente infinito. Circolare prima che la parola diventasse di moda. Eccellente nel saper fare prima del voler dire.

Twils è un po' come un albero, ho pensato quando ho incontrato i fondatori: si prende cura di quello che produce e le sta intorno, ha radici solide ma quando serve guarda verso il cielo.

Un'azienda che produce imbottiti e che ci è arrivata per la via più difficile: quella costruita sull'esperienza di un saper fare vero, perfezionando l'arte dell'imbottitura dei cuscini, poi dei letti e, in ultima battuta, mettendo a prova la propria sartorialità. Il risultato: una manifattura pregiata e gusto per i tessuti di qualità nel mondo del

living. Un Better Living. Fatto di imbottiti di alta qualità proposti a un prezzo giusto, forieri di un lusso non ostentato ma ben visibile agli occhi di chi sa: quello dei materiali realizzati con cura, delle tecnologie che permettono la naturalezza dei gesti nella realizzazione delle funzioni, della sostenibilità della filiera e della durabilità del manufatto. Un Better Living che dà serenità e sicurezza e alimenta il desiderio di prendersi cura nella propria casa per viverla con un'intensità diversa, capace di accompagnarci nei cambiamenti.

Se Twils è un albero, il compito che mi è stato assegnato è quello del giardiniere appassionato, che lo cura con dedizione perché continui a crescere. Seminando un Better Living condiviso.

Matteo Ragni

Imagine yourself lying on the grass under the leafy branches of a tree. Few situations give such intense and true pleasure. That's because looking afar, towards the sky, immersed in nature, is what we were born for even though we often forget it.

Nature is part of the present and also the past, it is life regenerated season after season. A perfect design project, uniting form, function and memory, a constant source of inspiration.

Nature and design help us imagine a better place to live, a place that comes to life with the lightness of the sky and the tangible nature of the earth, the flexibility of transformation and the lasting quality of materials crafted by skilled hands.

This is the inspiration behind our Better Living collection, guided by the creative direction of Matteo Ragni.

Twils's story is very Italian. Its origins are deeply rooted in the territory, it has a short production chain, meaning it supplies and is supplied by a network of local suppliers in a potentially never-ending virtuous circle. Its approach is circular, even before the word became trendy. And it has a reputation of knowing what it is talking about.

Twils is a little bit like a tree, I thought when I first met the founders of the company: it takes care both of what it produces and its surroundings, it has strong roots but when needed looks towards the sky.

Success did not come easily for this company which produces upholstered furniture: it took its experience and know-how, perfecting the art of padding and upholstering cushions, moving on to beds, and then, lastly, to fine tailoring. And the result was supe-

rior workmanship and a love for quality fabrics for the living space. A Better Living. With top-quality padded and upholstered elements offered at the right price, heralding a luxury which is understated but clearly visible to those who know what to look for: the luxury of materials made with care, technologies offering functions that are revealed with a simple gesture, the sustainability of the production chain and the durability of the product. A Better Living that instils serenity and safety, encourages us to take care of our homes so we can live them to the full, and guides us through inevitable change.

If Twils is a tree, my task is that of a passionate gardener, who tends to it lovingly, so it can continue to grow. Sowing a Better Living for us all.

Matteo Ragni

Sensibilità contemporanea, made in Italy, sofisticata naturalezza. I divani Twils prendono corpo per diventare uno strumento dei nostri rituali quotidiani nel luogo che più ci appartiene, la casa. E alla casa regalano il vero stile: quello in cui eleganza e funzione viaggiano sempre di pari passo.

Contemporary awareness, made in Italy quality, sophisticated simplicity. Twils sofas inevitably become an important part of our everyday lives in the one place that speaks to us the most - our home. And they bring style to the room, with elegance and function going hand-in-hand.

divani sofas



Etan

design
Robin Rizzini

Un divano geometrico ma non schematico, con una forte personalità estetica, per chi ama il design puro. Con i piedi dedicati in finitura black nickel che sorreggono la sua struttura dal look aereo, pensata per regalare il massimo comfort, Etan è una presenza decisa, un equilibrio perfetto di robustezza ed eleganza.

Etan is a geometric but not schematic sofa, whose strong aesthetic is guaranteed to appeal to lovers of pure design. With its black nickel finished feet which support the light and airy structure designed to ensure maximum comfort, Etan makes a statement in any room, the perfect balance between sturdiness and elegance.

Simplit
tavolino coffee table

leather Silk D71
col. 010 cat. Plus





Condé
tavolino coffee table

leather Silk D71
col. 010 cat. Plus

fabric Linen E04
col. 015 cat. Must





fabric Linen E04
col. 015 cat. Must

Orion
tavolino coffee table

La leggerezza si vede dai dettagli. Come la base dallo spessore ridottissimo, i piedini quasi invisibili, l'inclinazione dello schienale che accoglie i cuscini separati tra loro, gentili e ariosi. Aerodinamico.

The lightness of Etan is accentuated by its details: the base is ultra-slim, the feet are almost invisible and the backrest is set at an angle with separate, welcoming and generous cushions. Aerodynamic.

Orion
servetto side table

fabric Asolo E11
col. 014 cat. D





Biggie

design
Luca Nichetto

Volevo un progetto camaleontico, sotto tutti i punti di vista. Modulare, con una dimensione che idealmente cresce all'infinito. E al contempo volevo anche un divano semplice, tradizionale, a due o tre posti. Incontestabilmente comodo, morbido. Adatto agli spazi contract come al soggiorno di casa. E a tutti i luoghi che abitiamo oggi, in cui le funzioni si sovrappongono in modo spontaneo. Un prodotto comprensibile in ogni parte del mondo: in Europa come in Estremo Oriente. E infine un oggetto che nasce da un processo industriale semplice e intelligente.

I was looking for a project that was chameleonic, in all respects. Modular, with a dimension that can grow, ideally, infinitely. And, at the same time, I also wanted a simple, traditional two or three-seater sofa. Unquestionably comfortable, soft. Equally suitable for business environments or our living rooms. And for all the places we inhabit today, where functions naturally overlap. A product that's understood anywhere in the world: from Europe to the Far East. And finally, a piece constructed via a simple, yet clever manufacturing process.

struttura structure
fabric Pure D57
col. 003 cat. D

cuscini cushions
fabric Gallery E05
col. 004 cat. Must

Biggie
tavolino coffee table



1. La direzione

Matteo Ragni e Luca Nichetto si conoscono da tempo, non è difficile immaginare il clima della loro conversazione su Twils. Il tema è l'identità, perché è dall'azienda che comincia un buon progetto. Dice Luca Nichetto: *“Una nuova collezione contiene ogni parte del brand. Twils vuole evolvere nella zona giorno. Ma la parte più consolidata è quella della zona notte. Biggie le contiene entrambe: ho voluto creare un fil rouge che unisce e rilancia tutte le competenze dell'azienda”.*

1. The direction

Matteo Ragni and Luca Nichetto have known each other for quite some time, so it's not difficult to imagine the tone of their conversation about Twils. They are speaking about identity, because it's only from an understanding of a company's personality and values that strong designs can originate. Luca Nichetto says: *“A new collection encapsulates every aspect of the brand. Twils is looking to evolve in terms of furniture for the living area. But it's in the sleeping areas that its strengths lie. Biggie includes both: I wanted to create a fil rouge that combines and capitalizes on all the company's expertise and experience.”*

2. La struttura

È l'intuizione che dà struttura al progetto. Sembra paradossale, ma è sempre il lampo dell'intelligenza creativa che fa questa operazione. Il talento e, ovviamente, l'esperienza. *“Ho pensato allo scheletro del letto, e a quello del divano. Ridotti ai minimi termini non sono dissimili. Una struttura rigida che contiene una parte morbida. Quindi ho progettato innanzitutto una scocca, uno scheletro che esprime diverse possibilità, diverse soluzioni”.*

2. The structure

The design's structure is the fruit of intuition: it might seem a little paradoxical, but this always comes from a flash of creative genius. Talent and, of course, experience. *“I considered the structure of both the bed and the sofa. If you reduce them to the bare minimum, they are not too dissimilar. A rigid structure which contains a soft element. So, first of all, I designed a shell, a structure which offers different possibilities, different solutions.”*



3. Il progetto

Luca Nichetto è cresciuto fuori e dentro le fornaci muranesi, ascoltando i racconti di chi fabbrica e respirandone il clima un po' rude. Gli piace parlare con gli operai e gli artigiani: dice che ogni volta è come prendere un master in design. È insieme a loro che sconfinano dai limiti ordinari della produzione. Del resto il buon progetto dipende anche dall'intensa riflessione sui processi produttivi. *"La scocca di Biggie può essere stampata con uno o due braccioli. Oppure senza. Un solo stampo per ogni componente della collezione: con bracciolo diventa parte finale del divano, senza diventa modulo, con entrambi i braccioli è poltrona".*

3. The design

Luca Nichetto grew up in and around the furnaces of Murano, listening to the stories of glass artisans, immersed in a no-frills environment. He used to love chatting with the workers and craftsmen: he says it was like taking a master's in design every single time. And it was with them that he learned to push beyond the ordinary limits of production. After all, good design also means carefully taking into consideration the production processes that will be required. *"The Biggie shell can be moulded with one or two armrests. Or even none. Just one mould for each component of the collection: with just one armrest we have the end section of a sofa, with no armrest it becomes a module, and with both arms it's an armchair."*

struttura structure
fabric Natural 679
col. 010 cat. D

cuscini cushions
fabric Simi E02
col. 056 cat. Must

Biggie
tavolino coffee table





4. L'industria

Il processo industriale è alla base. Nella sua realtà si trovano i confini corretti e, di conseguenza, anche le soluzioni giuste. Un sistema che si sviluppa intorno a un unico stampo rende prioritaria la scalabilità dell'investimento industriale. In poche parole: mettersi dalla parte dell'azienda e sovrapporre i suoi bisogni alle finalità del progetto vuol dire lavorare a un progetto completo, che gestisce ogni parte della complessità industriale.

4. The manufacture

The manufacturing process provides the foundation. It's there that we discover all the limits of what's feasible, but it's also there that we find the solutions. Having a system that's developed around a single mould makes the scalability of the manufacturing absolutely key. In other words: putting yourself in the manufacturer's shoes and making their needs correspond with the aims of the design means coming up with a complete design, one that takes into consideration all the complexities of the manufacturing process.

Fizz
tavolino coffee table

struttura structure
fabric Naxos D57
col. 020 cat. D

cuscini cushions
fabric Miami E07
col. 032 cat. Must

5. La geografia

Biggie è una collezione con una composizione originale che trova ragione in una semplice constatazione: esiste una geografia del gusto e delle abitudini. *“Il Sud Europa ama i divani modulari. Il Centro, il Nord e il Far East, soprattutto nelle fasce alte, preferiscono configurazioni da due o tre posti”*. L'estetica di Biggie funziona sia free standing che in versione modulare. È basata su uno schema versatile, ripetitivo. Che però esprime diverse tipologie: il divano, il letto, una chaise longue dalle dimensioni importanti. C'è tutto: il nord, il sud. La razionalità, la morbidezza. Biggie è, come dice il suo nome, una collezione ampia.

6. La chiave

“Ho cercato un progetto passepartout. Né contract né residenziale. Una composizione di dettagli formali di entrambi i mondi, piuttosto. Per dare a Twils uno strumento utile ad aprirsi a nuovi mercati”. L'impatto visivo è di grande comfort, con cuscini ampi e morbidi, una seduta alta e profonda. Il pensiero ergonomico è evoluto. E c'è una parte profondamente funzionalista, con le scocche che agganciano ciascun modulo a un binario di lunghezza aggiustabile. Un piccolo spazio divide una seduta dall'altra: una memoria da prodotto tecnico, destinato a un uso collettivo. Ha ragione Luca Nichetto: Biggie è un passepartout contemporaneo.

7. Il genere

Imbottito sta per morbido. Gentile, accogliente. Biggie ha un genere, ed è femminile. Nella razionalità della soluzione dello stampo unico, nella vicinanza di istanze opposte, nella ricerca estetica che media diverse culture e diversi modi di vivere. La forma di Biggie: la curva dolce nella scocca di legno è delicata, poetica. Va cercata però.

5. The geography

Biggie is a collection consisting of an original composition that finds its rationale in one simple observation: tastes and habits are governed by geography. *“Southern Europe loves modular sofas. The Centre, the North and the Far East, especially further north, prefer configurations consisting of two or three seats.”* The Biggie aesthetic works in both free-standing mode and in the modular version. It's based on a versatile, repetitive framework. But which can be configured to create different forms: the sofa, the bed, an ample chaise longue. It's all there: north and south. Rationality, softness. As the name suggests, Biggie is an extensive collection.

6. The key

“I was looking for a passepartout design. Not business nor residential. But rather, a composition that encompassed the formal details of both worlds. To provide Twils with a key for opening doors onto new markets.” The visual impact is one of extreme comfort, with large, soft cushions and a high, deep seat. The ergonomic aspect has undergone an evolution. And there's also a deeply functional aspect, with the structures of each module able to be secured to bars of varying lengths. A small space divides one seat from the next: a remnant typical of a technical product intended for collective use. Luca Nichetto is right: Biggie is a contemporary passepartout.

7. The gender

Padded means soft. Gentle, welcoming. Biggie has a gender, she's feminine. This is apparent in the rationale of using a single mould, in the nearness of contrasting details, in the desire for an aesthetic that unites different cultures and ways of living. The shape of Biggie: the gentle curve of the wooden structure, delicate, almost poetic. But your eyes have to be open to it.



struttura structure
fabric Velvet 969
col. 070 cat. Must

cuscini cushions
fabric Linen E04
col. 150 cat. Must

Biggie
tavolino coffee table







Biggie
tavolino coffee table

struttura structure
fabric Linen E04
col. 003 cat. Must

cuscini cushions
fabric Linen E04
col. 003 cat. Must

Simplifit
tavolino coffee table

struttura structure
fabric Vancouver E25
col. 100 cat. Must

cuscini cushions
fabric Vancouver E25
col. 100 cat. Must





struttura structure
fabric Silk D71
col. 010 cat. E-Plus

cuscini cushions
fabric Silk D71
col. 010 cat. E-Plus

Fizz
tavolino coffee table

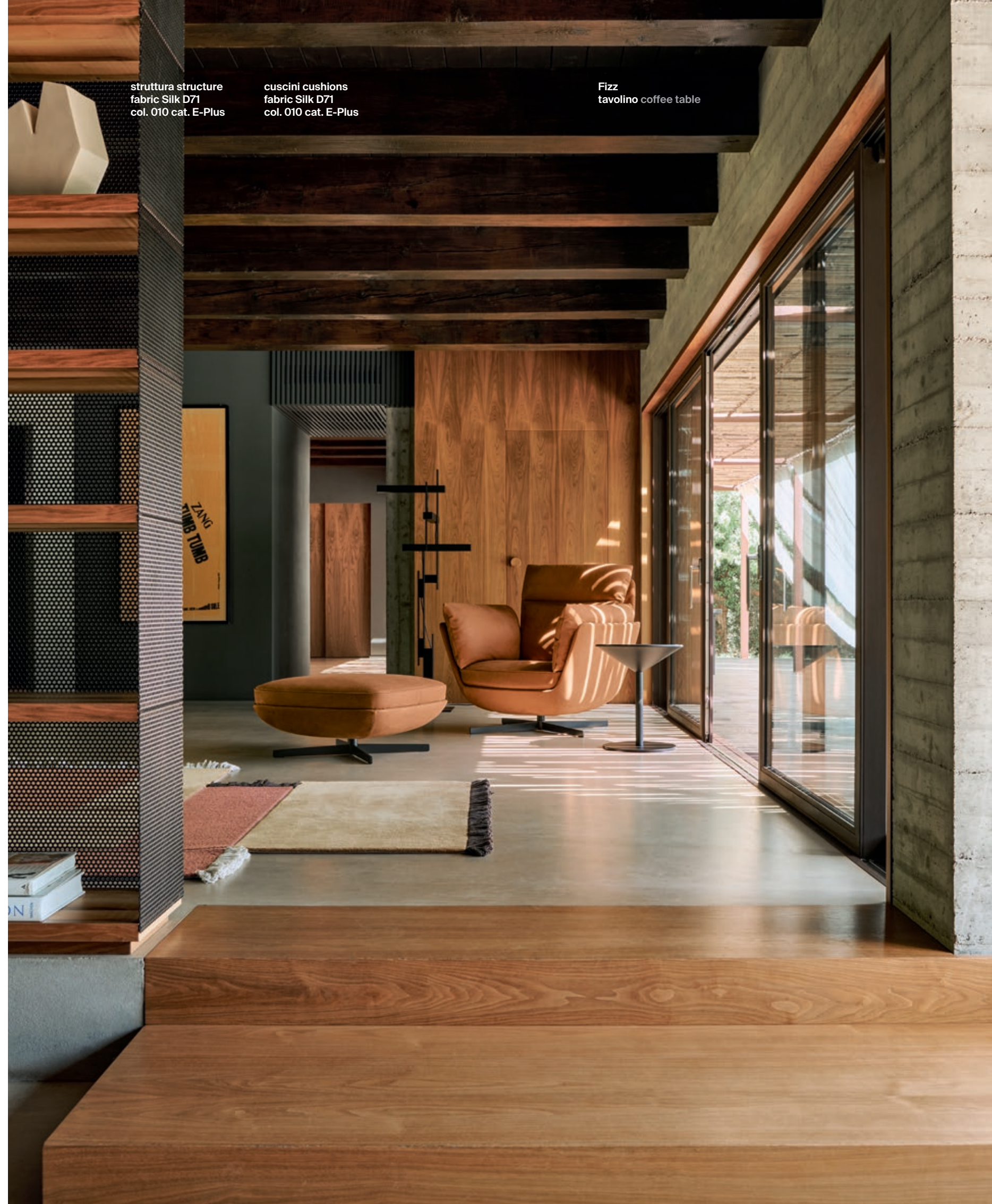



T—Pad

design
Matteo Ragni

Mutevole come il tempo, ma sempre un punto di riferimento. T—Pad è chaise longue, divano per il living, isola per il contract e moltissime altre cose. Grazie ai moduli facilmente agganciabili e sganciabili, ai tre differenti braccioli, all'elemento pentagonale e alla penisola a goccia, T—Pad può cambiare fisionomia alla stanza e generare paesaggi domestici sempre nuovi.

Times change, and so does T—Pad, but it is always a benchmark. T—Pad is a chaise longue, a sofa for the living room, an island for the contract sector and lots more besides. Thanks to its modules which can easily be hooked and unhooked, three different armrests, the five-sided element and the drop-shaped island, T—Pad can change a room's look and give your home fresh new appeal.

Quarto
tavolini coffee tables

Orion
servetto side table

fabric Linen E04
col. 016 cat. Must

fabric Biarritz E03
col. 010 cat. Must

Condé
servetto side table





I moduli di T-Pad si agganciano e sganciano con gesti immediati e naturali, senza l'ausilio di viti o sistemi

complessi. La riconfigurabilità tra i vari elementi è totale: per i momenti dei grandi cambiamenti o negli

spazi contract, ma anche nelle piccole e significative trasformazioni quotidiane nelle nostre case.

The T-Pad modules hook and unhook in a simple and intuitive manner without the need for screws or compli-

cated mechanisms. The different elements offer endless configuration options: you can revolutionise your

space, apply it to a hospital-ity environment or maybe just make small, important changes in your home.

fabric Davos E23
col. 021 cat. Must



fabric Velvet 969
col. 070 cat. Must

Orion
servetto side table



fabric Velvet 969
col. 070 cat. Must

Orion
servetto side table





La cucitura pinzata sugli angoli permette di mantenere la regolarità negli spigoli quando si agganciano i vari moduli; quella a doppio filo, piatta sulla parte orizzontale di seduta a contatto con le gambe, rende piacevole e morbida la forma.

The pinched stitching along the edges gives continuity to the corners when the different modules are connected; the double thread stitching, which is flat on the horizontal part of the seat that comes into contact with the legs, makes the shape soft and pleasant.





Quarto
tavolino coffee table

fabric Linen E04
col. 007 cat. Must

cuscini cushions
fabric Velvet 969
col. 010 cat. Must



fabric Bouclé D61
col. 001 cat. K
Orion
tavolino coffee table





fabric Natural 679
col. 020 cat. D
Orion
tavolino coffee table



Orion
servetto side table



Twils all'M9 di Mestre: radici e amore per il territorio

Twils at the M9 in Mestre: roots and love for the territory

fabric Pure D57
col. 004 cat. D

Quarto
tavolini coffee tables

Alcune delle immagini che trovate in questo catalogo sono state scattate in una location d'eccezione: "Foresta M9. Un paesaggio di idee, comunità e futuro", la prima mostra temporanea del 2021 di M9, il Museo del Novecento di Mestre. Un'installazione al terzo piano del museo, con oltre seicento essenze arboree e duecento alberi alti fino a quattro metri che, nel pensiero dei curatori Luca Molinari e Claudio Bertorelli, racconta il profondo legame del territorio veneziano e veneto verso i suoi boschi.

Un legame molto vivo anche in Twils, che affonda le proprie radici in terra veneta e nel mix di natura, industria e artigianalità che la caratterizzano.

Un'occasione per vivere in prima persona il senso del nostro Better Living e il nostro impegno nella promozione e nella cura del territorio cui apparteniamo.

Some of the photos in this catalogue were taken at a very special location: "Forest M9. A landscape of ideas, community and future", the first temporary exhibition of 2021 at M9, the Museum of the 20th Century in Mestre. The installation on the third floor of the museum featured over six hundred tree species and two hundred trees up to four metres high and, in the mind of curators Luca Molinari and Claudio Bertorelli, symbolized the close relationship Venice and the Veneto have always had with their woodlands.

This bond is strong at Twils too, whose roots are in the Veneto and its nature, industry and artisan tradition.

An occasion to experience our concept of Better Living first-hand and our commitment to promoting and protecting our local area.



Da serpentone, per gli ambienti contract, a love sofa, per la casa, con i suoi schienali, profondi o molto sottili e il modulo a goccia che funge da poggiatesta o dormeuse, T-Pad è adatto a qualsiasi ambiente.

Whether it is configured as a complex, winding element for the contract industry, or a love sofa at home, with backrests which can be either deep or very narrow, and the drop element that acts as a footrest or daybed, T-Pad is at home in any room.



Harold

design
Robin Rizzini

Divano geometrico e moderno, dalle linee essenziali, che gioca su un sottile equilibrio tra rigore formale e comfort. La seduta ne esalta la morbidezza, il design è moderno: perfetto per dare carattere all'ambiente.

Con cuscini di seduta singoli esprime il suo migliore carattere ma, nella versione a tre posti con unico cuscino, può all'occorrenza trasformarsi in un comodo letto per ospiti.

A modern, geometric sofa featuring clean, minimalist lines striking a fine balance between formal rigour and comfort. The seat escalates the softness, the design is modern: perfect for bestowing character on the surrounding space. This sofa is at its very best with single seat cushions but, in the three-seater version with a single cushion, it can be transformed into a comfortable bed for guests when the need arises.

fabric Davos E23
col. 019 cat. Must

Simplit
tavolino coffee table





Fizz
tavolino coffee table

fabric Linen E04
col. 015 cat. Must

Clove
pouf footstool



fabric Simi E02
col. 009 cat. Must

Orion
tavolino coffee table





Wing

design
Tiziano Carnieletto

Nella vita bisogna prendere posizione. Un divano può aiutare a farlo con eleganza, mettendo le ali alle nostre scelte, ai nostri momenti migliori.

It's necessary to take a position in life. A sofa can help you do it with elegance, giving wings on your choices, on your best moments.

fabric Gallery E05
col. 008 cat. Must



Rica
poltrona armchair

Simplit
tavolino coffee table

fabric Miami E07
col. 031 cat. Must



Attraverso un bracciolo e uno schienale regolabili come un'ala, Wing permette di personalizzare il comfort secondo il gusto, modellando pose ora classiche ora informali.

Thanks to armrests and backrests that adjust like a wing, Wing allows comfort to be personalised according to tastes, offering classic or informal positions as desired.

fabric Miami E07
col. 015 cat. Must

Orion
tavolino coffee table





Nubes

design
Studio Viganò

Vivere sulle nuvole, ma con i piedi per terra. Anche a questo serve il design di un divano: conciliare l'impossibile, unire il sogno alla normalità della vita di tutti i giorni.

Living in the clouds but with feet firmly on the ground. The design of a sofa also serves this purpose: to reconcile the impossible and merge the dream into the normality of everyday life.

fabric Naxos E06
col. 008 cat. Must



A ciascuno il suo posto, regolabile grazie al movimento dello schienale che offre comfort massimo nella varietà delle pose e garantisce la comodità totale anche a persone di altezze diverse.

To each one his place, adjustable thanks to the backrest movement mechanism that offers and guarantees the utmost comfort in an array of positions whatever a person's height.





fabric Naxos E06
col. 063 cat. Must
Simplit
tavolino coffee table

fabric Naxos E06
col. 021 cat. Must

Orion
tavolino coffee table

Condé
servetto side table





T-Time

design
Matteo Ragni

Vivere il proprio tempo in una dimensione senza tempo. In equilibrio perfetto tra eleganza e informalità, seduti su un divano che non insegue lo stile ma lo detta. In T-Time libertà e rigore si fondono nella linea ideale per chi cerca in un unico pezzo pose classiche e contemporanee. T-Time è un ponte che unisce stili di vita opposti. E, anche per questo, un arredo senza tempo.

Spending your time in a timeless dimension. Perfectly balanced between elegance and informality, sitting on a sofa that dictates the style rather than just follow it. T-Time combines freedom and rigour in an ideal line for those who seek both the classic and the contemporary in a single piece. T-Time acts as a bridge that unites opposing lifestyles. That is another reason why it is a timeless piece of furniture.

fabric Linen E04
col. 015 cat. Must



La seduta con tre differenti densità di gomma e il materassino di piuma, insieme allo schienale in piuma e fibra di poliestere anallergica, fanno di T-Time un divano estremamente versatile e riconfigurabile a più posti, caratteristica assai rara in un pezzo d'ispirazione classica.

The seat cushion with three different densities of foam and feather-filled wrap, plus the backrest in feathers and non-allergenic polyester fibre make T-Time an extremely versatile sofa, which can be rearranged to create the number of seats you want – a very rare feature in a classically inspired piece.



Simplit
tavolino coffee table

fabric Biarritz E03
col. 000 cat. Must





fabric Miami E07
col. 032 cat. Must

Orion
servetto side table





Avenue

design
Tiziano Carnieletto

Portare in casa la strada, la vitalità e i fermenti di uno spazio urbano. Perché è lungo la strada che le vite si uniscono e si intrecciano. Avenue è un inno alla cultura di strada, il divano che più di tutti asseconda il bisogno di vivere ognuno secondo il proprio gusto: liberi in mezzo agli altri.

Bring the street, the vitality and the turbulence of an urban space into the home. Lives intertwine and merge along the street. Avenue is an ode to street culture and is the sofa to indulge the need to live as you want: free in the midst of others.



La configurabilità di questo divano è totale, grazie a blocchi e cuscini giostrabili a seconda delle situazioni o del gusto. C'è un Avenue per chi è solo, uno per chi è in compagnia, per chi vuol stendersi o rannicchiarsi. Guardare l'altro negli occhi o riposargli accanto.

The configuration of this sofa is totally flexible, thanks to bolsters and cushions that can be changed around according to situations or simply tastes. There is an Avenue for a person on their own, one for those who have company, one for whoever wants to stretch out or curl up. To look the other person in the eyes or to rest against them.

fabric Linen E04
col. 003 cat. Must



fabric Linen E04
col. 003 cat. Must

Condé
servetto side table



fabric Naxos E06
col. 054 cat. Must





Balmoral

design
Cairoli & Donzelli

Ci hanno insegnato che less is more, meno è meglio, ma perché rinunciare alle forme generose? Balmoral è la sfida, vinta, di realizzare un divano moderno ma non minimale. Linee nette e rigorose disegnano forme accoglienti, configurabili all'infinito.

We were taught that less is more, but why give up generous shapes? Balmoral is the successful result of the challenge to make a sofa with a modern but not minimal design. Clear-cut, severe lines create welcoming shapes, which can be arranged in countless ways.

leather Silk D71
col. 005 cat. Plus

Simplit
tavolino coffee table

Solido e imponente ma con un'anima leggera. Balmoral è come una cornice: discreta, preziosa, di carattere, traccia il perimetro ideale dei nostri momenti più belli. Una cornice potenzialmente infinita, da allungare a piacimento aumentando i posti a disposizione.

Sturdy and imposing yet agile at heart. Balmoral is like a frame: discreet, valued and distinctive, it outlines our loveliest moments. A potentially endless frame that can be extended at will to increase the available seating area.



fabric Biarritz E03
col. 031 cat. Must



fabric Simi E02
col. 021 cat. Must

Orion
tavolini coffee tables





Newport

design
R&D Twils

Un divano che esprime un sapore senza tempo, tipico della classicità mediterranea. Pensato per accogliere, modulare nelle configurazioni e disponibile in più misure, è testimonial della cura di Twils nella realizzazione dei dettagli: dalle cuciture alle imbottiture.

The Newport sofa exudes a timeless appeal, typical of the classical Mediterranean style. Warm and welcoming, modular and available in several different sizes, it is the perfect example of the Twils attention to detail: from the stitching to the padding.



fabric Eden A64
col. 001 cat. Must

Condé
servetto side table





fabric Eden A64
col. 001 cat. Must

Condé
servetto side table

Design vuol dire non lasciare nulla al caso: far dialogare forme e ispirazioni diverse, mescolare elementi apparentemente opposti per creare un nuovo unicum. Da questa speciale ricerca di equilibrio nasce Newport, un concentrato di eleganza classica e comfort contemporaneo.

Design means leaving nothing to chance: bringing together different shapes and inspirations, mixing seemingly contrasting elements to create something completely new. This unique balance has been successfully achieved with Newport, a powerhouse of classical elegance and contemporary comfort.



fabric Pure D57
col. 019 cat. D

Simplit
tavolino coffee table





Antibes

design
R&D Twils

Una certezza. Antibes è un divano solido e affidabile, raffinato e curato nei dettagli ma non esagerato nella forma. Il suo stile, semplice e rassicurante, è perfetto per esprimere una bellezza senza tempo e pensato per dare un tocco di sofisticata eleganza agli interior.

A certainty. Antibes is a solid, reliable presence, a refined sofa with flawless details that is not overly large. Its simple, reassuring style conveys timeless beauty, adding a touch of sophisticated elegance to any interior.

Simplit
tavolini coffee tables

fabric Salinas E15
col. 012 cat. D



fabric Pure D57
col. 018 cat. D



fabric Pure D57
col. 018 cat. D



fabric Eden A64
col. 083 cat. Must

Orion
servetto side table



Configurabile grazie alla presenza di più moduli, Antibes è una soluzione adattabile a qualsiasi ambiente.

Antibes is a modular sofa with several different elements, so it can be tailored to your space.



Ascot

design
Tiziano Carnieletto

Elegantissimo nella forma, romantico e allegro, Ascot esprime uno spirito e uno stile che ricordano gli anni '50 e '60. Nella sua versione più classica, è sostenuto da piedini a cono bruniti con puntale personalizzabile, in oro satinato o black nichel. Mentre per un tocco contemporaneo si può scegliere la slitta a tubo, anch'essa personalizzabile in oro satinato o black nichel.

With its elegant lines and romantic yet cheerful appeal, the spirit and style of Ascot are reminiscent of the Fifties and Sixties. In its most classic version, it sits on burnished cone-shaped feet with a custom cap in satin-finished gold or black nickel. For a more contemporary look, you can choose a tubular sled base which can also be customised with the same finishes.

Il fascino dell'arredo che decora gli ambienti si mescola all'attenzione per il dettaglio moderno della base su cui appoggia il divano: a slitta o con piedini. L'effetto è sempre, e comunque, quello di una grande leggerezza.

The visual impact of the sofa combines with the contemporary detail of the base: sled or feet. Whatever your choice, the effect is always light and airy.



fabric Bouclé D61
col. 001 cat. K

Orion
tavolino coffee table





fabric Velvet 969
col. 019 cat. Must

fabric Velvet 969
col. 031 cat. Must

Condé
tavolini coffee tables

Condé
pouf footstool

fabric Velvet 969
col. 122 cat. Must

Come sospeso da terra, nella versione con la base a slitta, grazie all'elegante curvatura dei suoi braccioli Ascot aggiunge agli interior di oggi sapori dell'immaginario degli anni '50, l'epopea del benessere, regalandoci un senso di pace e serenità.

The model with the sled base appears to float above the floor, thanks to the elegantly curved armrests. Ascot brings a taste of the Fifties to today's interiors, the heyday of wellbeing, conveying a feeling of peace and quiet.



fabric Naxos E06
col. 021 cat. Must



La ricerca sugli stili di vita che diventa design. Nulla è più difficile che dare a ciascuno il proprio comfort e moltiplicare i modelli, mantenendo intatta l'identità progettuale. Le poltrone Twils rappresentano la sfida di interpretare le necessità contemporanee seguendo un fil rouge deciso, di carattere.

Research into lifestyles that becomes design. Nothing is harder than giving every armchair its individual comfort and coming up with more models, while remaining faithful to your signature style. Twils armchairs are testimony of the challenge of interpreting today's needs while following a unique and distinct aesthetic.

poltrone armchairs



PoLet

design
Achille Castiglioni

Ci sono poltrone che si trasformano in letti. Polet è un letto che diventa poltrona. O, meglio, un trono, con il suo schienale così alto che ne fa un arredo deliziosamente ironico e funzionale, nato non a caso trent'anni fa dal genio di Achille Castiglioni.

There are armchairs that convert to beds. Polet is a bed that becomes an armchair. Or, perhaps it would be more precise to say a throne, with its soaring backrest that makes it a delightfully ironic and functional piece of furniture, a design dreamt up by the genius Achille Castiglioni thirty years ago.



I gesti semplici sono quelli che cambiano la vita. È un arredo che si adatta a quello di cui abbiamo bisogno e che ci fa sentire a casa. Castiglioni ha progettato Polet perché si apra e chiuda con una naturalezza estrema, come fosse una sdraio.

It's the simple things that change our lives. Polet adapts to our needs and makes us feel at home. Castiglioni designed Polet to open and close as intuitively as possible, just like a deck chair.

fabric Natural 679
col. 012 cat. D



fabric Velvet 969
col. 084 cat. Must





Un po' nomade e un po' stanziale, un po' lettino da campeggio, un po' poltrona regale. Polet è nata dalla creatività di Achille Castiglioni per arredare la sua casa al mare. Legno di faggio laccato nero e perni in ottone: nei dettagli, il valore di questa poltrona-letto.

A mixture of the nomadic and the permanent, a bit like a camp bed but also a throne. Polet is the creative genius of Achille Castiglioni, who came up with the idea for his seaside house. The wood is black lacquered beech and the pins are brass: the beauty of this armchair-bed is in the details.





Moon

design
Matteo Ragni

Come su un'altalena. Un sofisticato gioco di simmetrie, grazie all'unico blocco che compone seduta e schienale, evoca un senso di piacevole morbidezza. Accomodarsi su una mezzaluna agganciata al cielo non è mai stato così semplice.

Moon is like being on a swing. A sophisticated play of symmetries, created by a single block forming the seat and backrest, induces a feeling of enjoyable softness. Sitting on a crescent moon hooked to the sky has never been so simple.

fabric Bellagio E12
col. 001 cat. K

bracciolo armrest
Cuoio 906 col. 100



fabric Simi E02
col. 050 cat. Must

bracciolo armrest
Cuoio 906 col. 101



Il bracciolo in aggetto comunica l'idea di sospensione di questa poltroncina geometrica e allo stesso tempo sensuale.

The overhanging armrest makes this geometric yet sensual armchair seem suspended.

fabric Bellagio E12
col. 001 cat. K

bracciolo armrest
Cuoio 906 col. 100





fabric Schmoze E35
col. 001 cat. K

fabric Louvre B14
col. 005 cat. E-Plus

bracciolo armrest
Cuoio 906 col. 102

Simplit
tavolino coffee table



Etan

design
Robin Rizzini

Poltrona che si ispira all'omonimo divano. Dalla forte personalità estetica, per chi ama il design puro, Etan è una presenza decisa, un equilibrio perfetto di leggerezza ed eleganza, senza trascurare il comfort.

An armchair that takes its inspiration from the sofa of the same name. With a strong aesthetic personality, for those who love pure design, Etan delivers a bold statement, a perfect balance between lightness and elegance, without overlooking comfort.

leather Silk D71
col. 011 cat. Plus

Simplit
tavolino coffee table





Rica

design
Beatriz Sempere

Romantica come un bocciolo in fiore che accoglie come in un abbraccio. Il sedile, con grandi e morbidi cuscini, e lo schienale arrotondato, creano un effetto corolla sottolineato dalla combinazione di tessuti e materiali diversi tra interno ed esterno.

This romantic armchair reminds you of a flowering bud which welcomes you into its embrace. The seat, with its generous, soft cushions, and the rounded backrest create a corolla effect which is further enhanced by the different fabrics and materials used inside and out.

fabric Velvet 969
col. 038 cat. Must

fabric Gloss C10
col. 001 cat. K



Le gambe anteriori sono visivamente staccate dal sedile che sembra fluttuare, suggerendo un senso di leggerezza. A guardarla, pare galleggiare, raccolta nell'avvolgente schienale.

The front legs are clearly detached from the seat, giving it the impression of floating and conveying a feeling of lightness. It looks suspended, embraced by the wraparound backrest.

fabric Simi E02
col. 011 cat. Must

leather Louvre B14
col. 002 cat. Plus





Adele

design
Antonio De Marco

Una poltrona che nasce da una sola regola: quella della semplicità, che serve a far dialogare con naturalezza gli opposti, come la scocca dalle linee decise, sapientemente imbottita, che regala il massimo comfort e i materiali diversi che la compongono, esaltandone le forme.

This armchair lives by one rule: simplicity. It reconciles opposites with natural flair, like the frame with its crisp lines and padding for maximum comfort and the different materials used in its construction, enhancing the shapes.



leather Silk D71
col. 004 cat. Plus

fabric Bouclé D61
col. 001 cat. K



fabric Sade E01
col. 813 cat. K

fabric Naxos E06
col. 054 cat. Must



fabric Davos E23
col. 018 cat. Must

fabric Hermitage 843
col. 001 cat. Luxury





T–Vision

design
Matteo Ragni

Per restare sempre morbidi ci vuole la stoffa giusta. O la pelle migliore. T–Vision è una vera e propria celebrazione del comfort made in Italy, una poltrona avvolgente dove la stoffa o la pelle esaltano le linee e amplificano la sensazione di relax.

Only the right material will always remain soft. Or the best leather. T–Vision is a true celebration of Italian comfort: a welcoming armchair in which the fabric or leather enhances the lines and heightens the feeling of relaxation.



leather Silk D71
col. 008 cat. Plus
fabric Naxos E06
col. 054 cat. Must



Staccarsi dalla folla non vuol dire per forza isolarsi: semplicemente, significa prendersi il proprio tempo, scrutare meglio ciò che ci circonda, aumentare la consapevolezza. E farlo seduti con il massimo comfort è impagabile.

Getting away from the crowd does not mean isolating yourself: it simply means taking the time to really observe what is around you, to increase your awareness. And there's nothing better than to do it while seated in absolute comfort.

leather Silk D71
col. 002 cat. Plus



leather Silk D71
col. 002 cat. Plus

Simplit
tavolino coffee table





Chocolat

design
Tiziano Carnieletto

**Tutto il gusto di stare comodi
mantenendo un perfetto
aplomb. La classicità che non
teme la morbidezza.**

**All the enjoyment of being
comfortable with perfect
aplomb. Classic shapes do
not fear softness.**

Un'anima avvolgente ricavata da un corpo squadrato e geometrico. Gli opposti si incontrano ed esaltano questa poltrona su cui posarsi con eleganza.

An embracing personality in a geometrical squared shape. Opposites meet and enhance this armchair, which invites you to gracefully relax.

fabric Frozen D78
col. 011 cat. D





fabric Sade E01
col. 603 cat. K

Set
librerie bookcases

L'incontro tra classicità e morbidezza caratterizza anche la versione pouf della poltrona, in formato quadrato o rettangolare.

Softness and classical appeal merge in the pouf version of the armchair which is available either square or rectangular.

leather Silk D71
col. 009 cat. Plus





Jolie

design
Tiziano Carnieletto

Si può dire di no a una carezza, ma prima bisogna trovare una ragione davvero valida per rifiutarla. Non cercatela in Jolie: delicata e avvolgente come una coccola inattesa.

Although you can say no to a caress, you should first find a truly valid reason to do so. Don't look for it in Jolie: delicate and welcoming like an unexpected embrace.

La poltroncina dal gusto classico ideale per qualsiasi contesto, incluso quello più informale cui aggiunge un'eleganza inaspettata.

The small classic style armchair looks good in any environment, even the most informal, adding a touch of unexpected elegance.

fabric Naxos E06
col. 023 cat. Must



fabric Velvet 969
col. 011 cat. Must

Condé
tavolino coffee table



La casa contemporanea richiede flessibilità, anche nei dettagli, e durabilità. I tavolini di Twils sono compagni discreti del quotidiano: supporti per libri, tazzine o bicchieri, superfici su cui appoggiare il computer portatile, ripiani su cui appoggiarsi comodamente mentre si chiacchiera o si guarda un film. Il loro design, curatissimo, si basa sulla ripresa di forme archetipiche interpretate per offrire la massima personalizzazione degli spazi living.

Today's homes must be flexible and durable, and their accessories are no exception. Twils coffee tables fit discreetly into our everyday lives, providing us with a surface for books, cups or glasses, somewhere to put our laptop and a comfortable place to sit as we chat or watch a film. Their flawless design is inspired by archetypical shapes of the past, brought up-to-date to customise our living spaces.

complementi furnishings

Orion

design
Tiziano Carnieletto

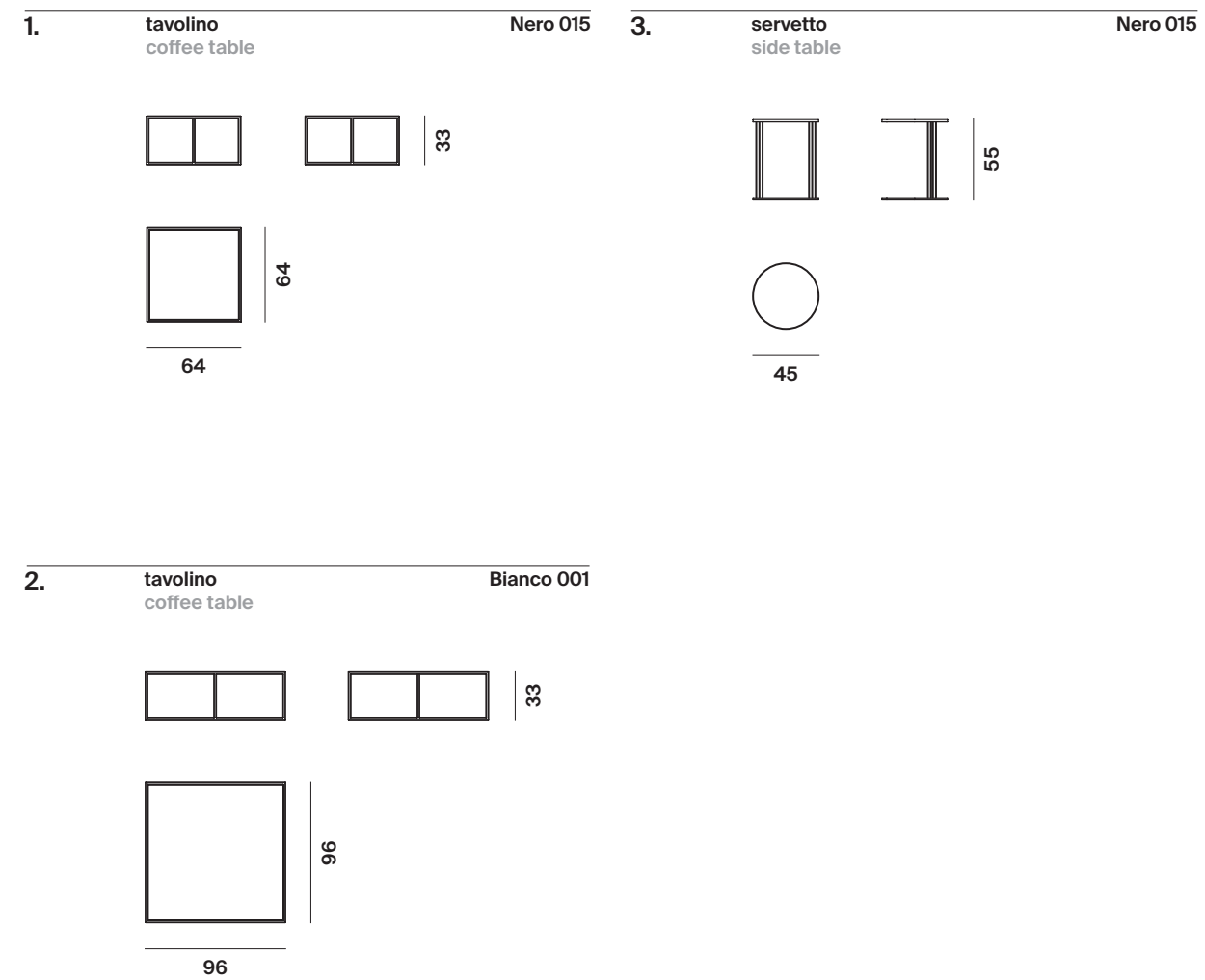

Condé

design
Silvia Prevedello



- | | | |
|----|------------------------|------------|
| 1. | servetto
side table | Nero 015 |
| 2. | servetto
side table | Oro 124 |
| 3. | servetto
side table | Bianco 001 |

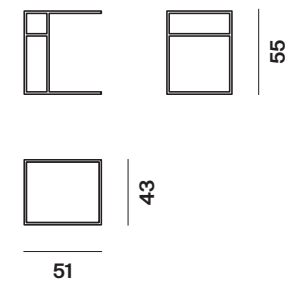



Quarto

design
Matteo Ragni

1. **tavolino** **Grigio scuro 025**
coffee table

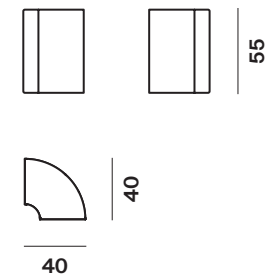

2. **tavolino** **Grigio scuro 025**
coffee table

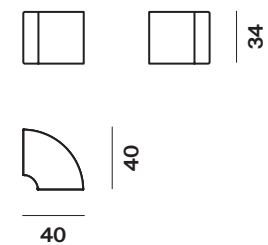

Set

design
Studio Viganò

- | | | |
|----|----------------------|------------|
| 1. | libreria
bookcase | Oro 124 |
| 2. | libreria
bookcase | Nero 015 |
| 3. | libreria
bookcase | Bianco 001 |

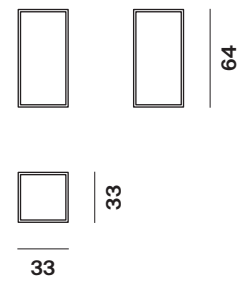

- | | | |
|----|----------------------|----------|
| 4. | libreria
bookcase | Nero 015 |
|----|----------------------|----------|

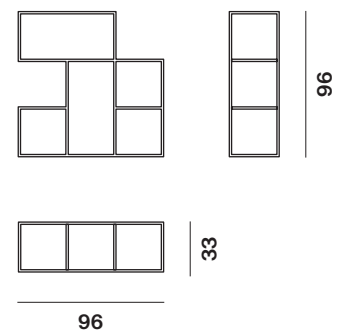

Simplit

design
Bottino & Tinti

1.	tavolino coffee table	Bronzo 123	7.	tavolino coffee table	Verde 013
2.	tavolino coffee table	Nero 015			
3.	tavolino coffee table	Nero 015			
4.	tavolino coffee table	Bianco 001			
5.	tavolino coffee table	Bianco 001	8.	tavolino coffee table	Nero 015
6.	tavolino coffee table	Nero 015			



Condé

design
Silvia Prevedello

1. **tavolino**
coffee table **Frassino tinto**



60

3. **pouf**
footstool **Frassino tinto**
fabric Bellagio E12
col. 001 cat. K

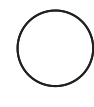

50

2. **tavolino**
coffee table **Frassino tinto**

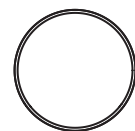

80



Clove

design
Silvia Prevedello

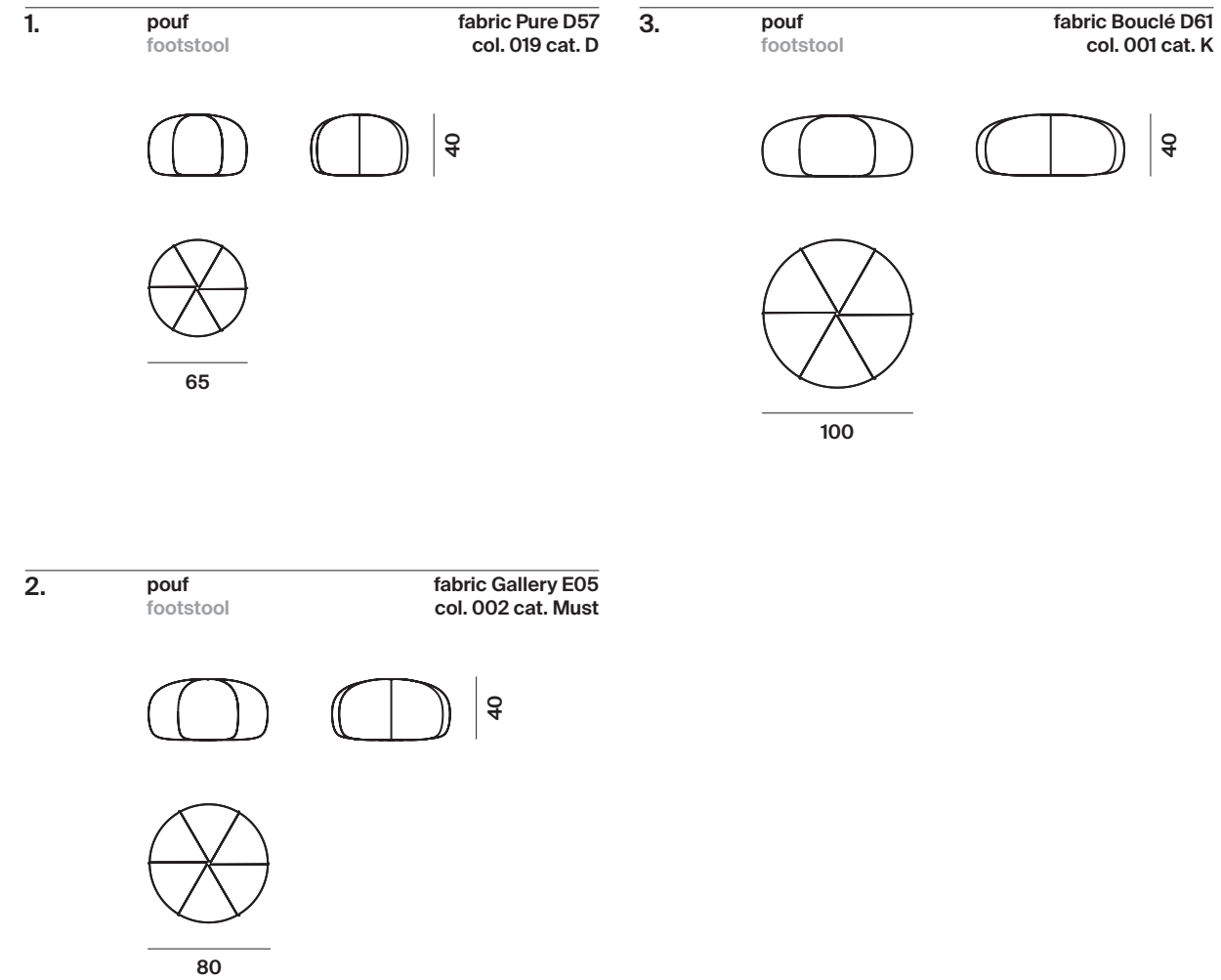

Chocolat

design
Tiziano Carnieletto

1. pouf
footstool leather Silk D71
col. 009 cat. Plus

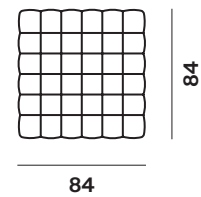
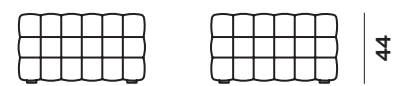

2. pouf
footstool leather Silk D71
col. 005 cat. Plus

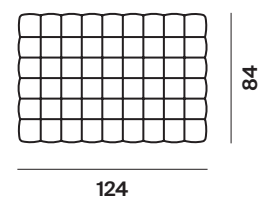

Fizz

design
Térence Coton

Un tavolino ispirato al rito dell'aperitivo. Durante le fresche serate estive i Navigli diventano un luogo dove la gente si incontra, mangia e beve intorno a un tavolino da caffè. Il design, ispirato alla forma iconica di un bicchiere da cocktail, è un invito a godersi un piacevole momento. Il piano del tavolo è disponibile in varie finiture: legno, quarzo o laccato, rendendolo adattabile a qualsiasi interno.

A coffee table inspired by the ritual of the aperitif. On cool summer evenings, Milan's Navigli area becomes a Mecca for people meeting, eating and drinking around coffee tables. The design, inspired by the iconic shape of a cocktail glass, is an invitation to enjoy a moment of pleasure and joy. The tabletop is available in a variety of finishes: wood, quartz or lacquered, making it adaptable for any interior space.

tavolino
coffee table

Nero opaco 015



55



47



Conversatio-on

design
Yuetong Shi

Collezione tessile ispirata alle relazioni umane, è stata ideata durante il lockdown dovuto alla pandemia, quando le social audio app sono diventate popolari e le persone riuscivano a connettersi tra loro grazie a conversazioni online. L'osservazione e l'esperienza diretta di molteplici tipi di comunicazione sono diventati il concetto del pattern stesso che, di fatto, rappresenta simbolicamente nelle sue varianti, diversi tipi di conversazione.

A collection of fabric materials inspired by human relationships, conceived during the Covid-19 lockdown, when social audio apps became popular and people were able to connect with each other through online conversations. Observation and direct experience of multiple types of communication became the concept behind the pattern which, indeed, symbolically represents the different types of conversation in their different forms.

Murmur cuscinò pillow

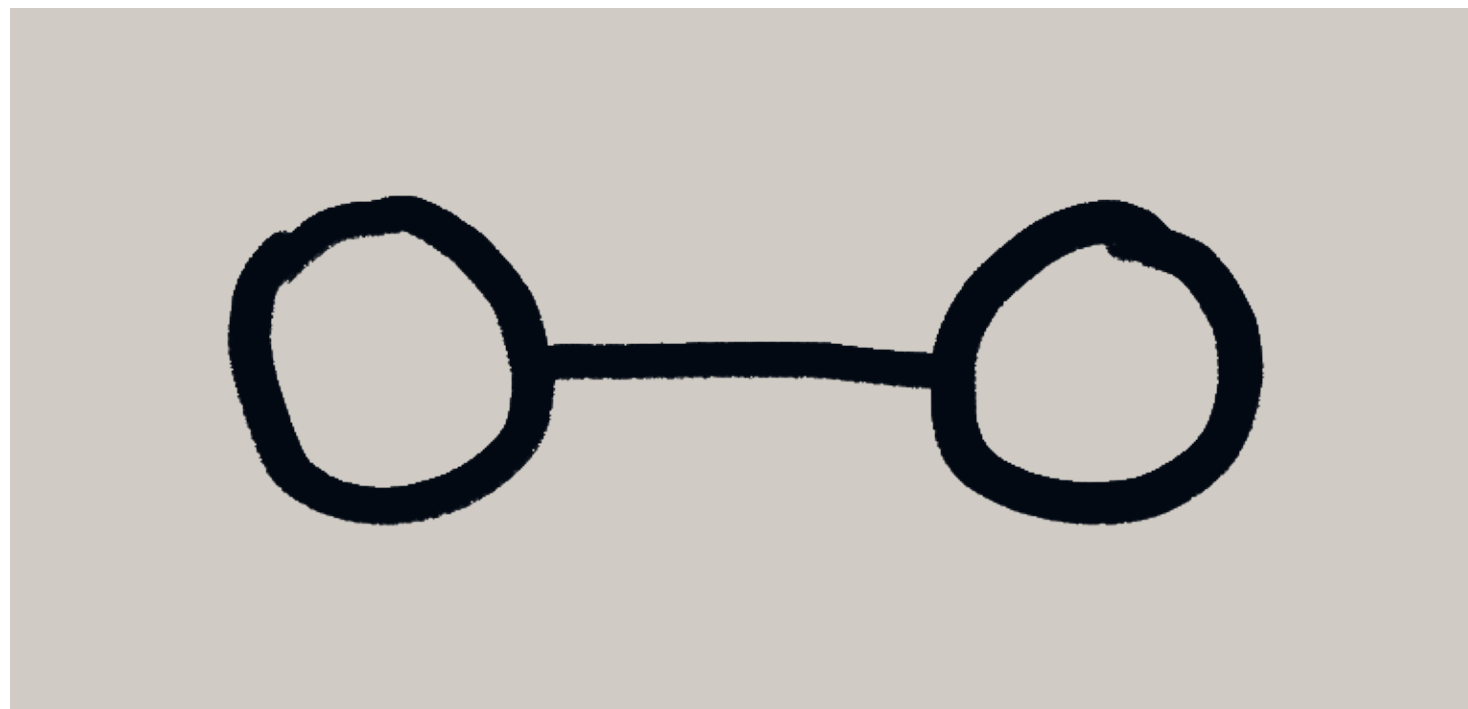

Schmooze cuscinò pillow

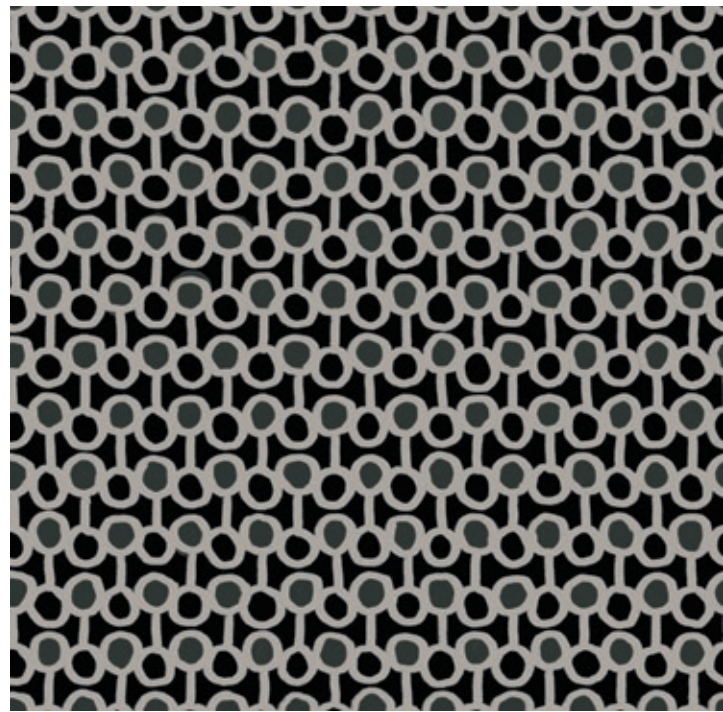

Dialogue biancheria letto bed linen

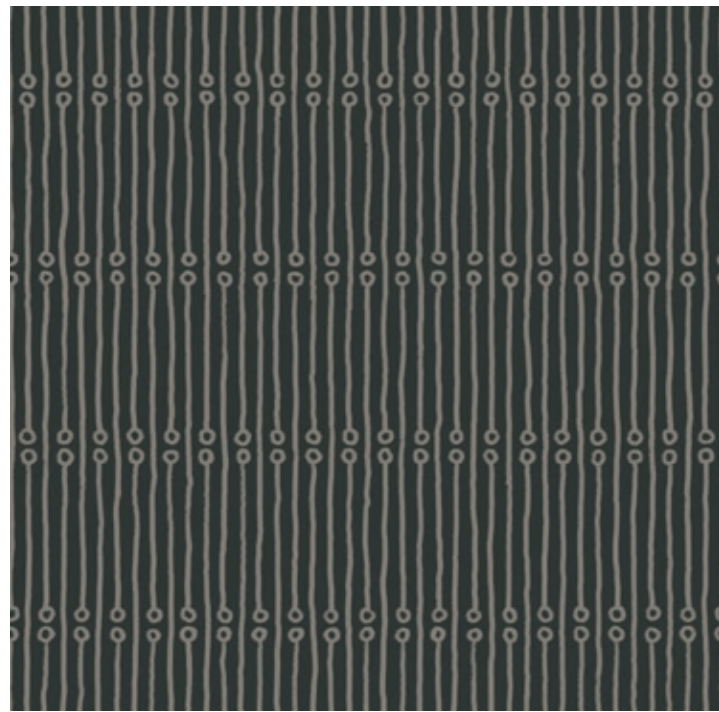

schneide technische data sheets

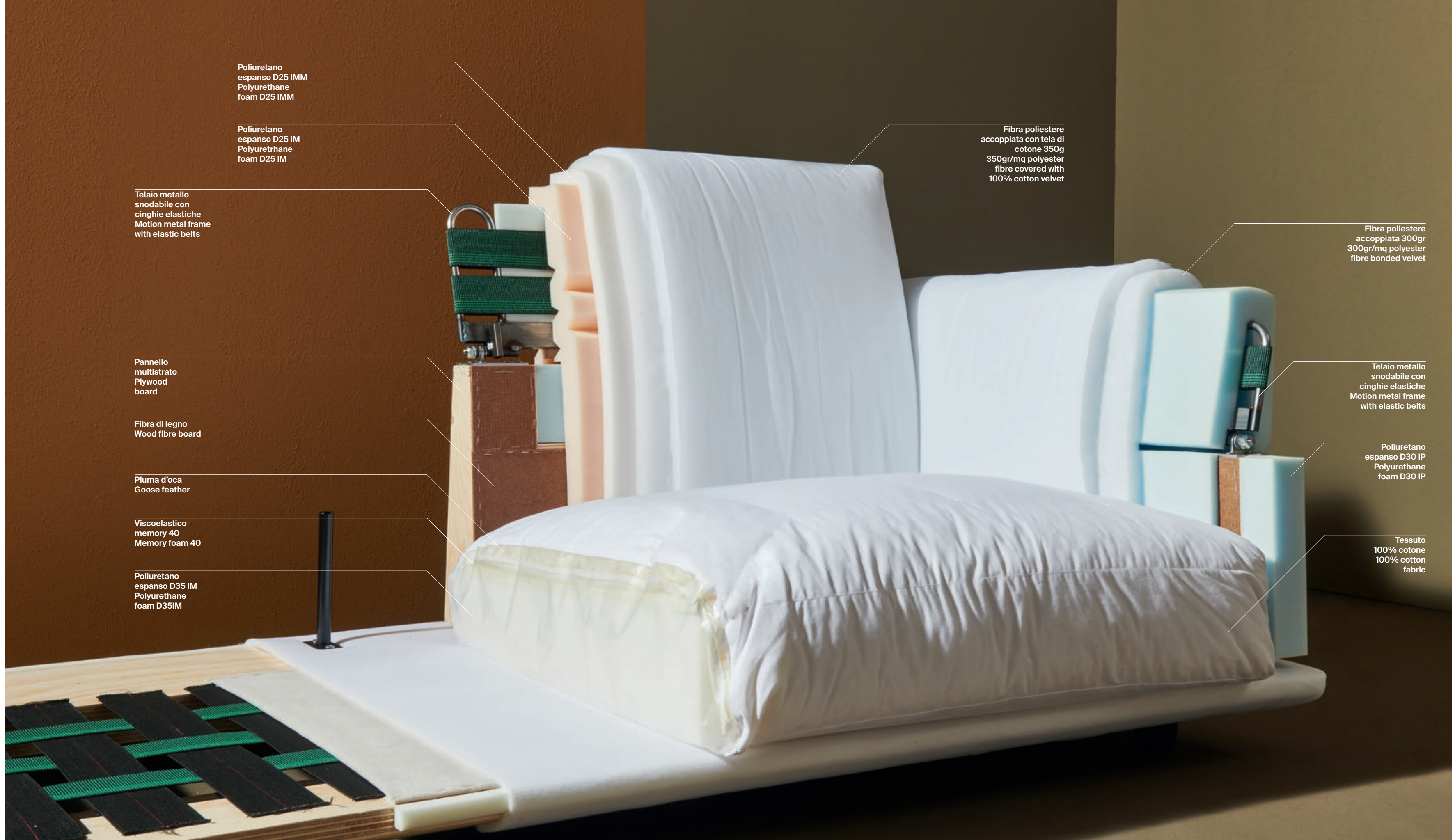

Poliuretano
espanso D25 IMM
Polyurethane
foam D25 IMM

Poliuretano
espanso D25 IM
Polyurethane
foam D25 IM

Telaio metallo
snodabile con
cinghie elastiche
Motion metal frame
with elastic belts

Pannello
multistrato
Plywood
board

Fibra di legno
Wood fibre board

Piuma d'oca
Goose feather

Viscoelastico
memory 40
Memory foam 40

Poliuretano
espanso D35 IM
Polyurethane
foam D35IM

Fibra poliestere
accoppiata con tela di
cotone 350g
350gr/mq polyester
fibre covered with
100% cotton velvet

Fibra poliestere
accoppiata 300gr
300gr/mq polyester
fibre bonded velvet

Telaio metallo
snodabile con
cinghie elastiche
Motion metal frame
with elastic belts

Poliuretano
espanso D30 IP
Polyurethane
foam D30 IP

Tessuto
100% cotone
100% cotton
fabric

Etan

design
Robin Rizzini

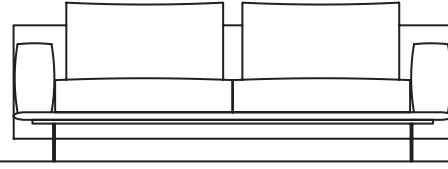
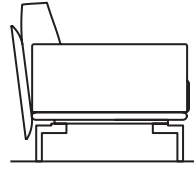

Un divano di carattere, pensato per regalare il massimo comfort all'insegna dell'equilibrio tra eleganza, leggerezza e robustezza.

This sofa is just bursting with personality and has been designed to ensure maximum comfort while maintaining the perfect balance between elegance, lightness and sturdiness.

altezza	height	84 cm
altezza seduta	seat height	43 cm
altezza bracciolo	armrest height	60 cm
profondità	depth	94 cm
profondità seduta	seat depth	65 cm

divani sofa

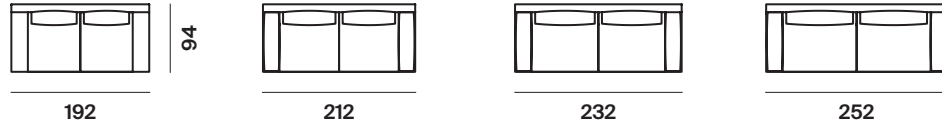

laterali sx side elements lh

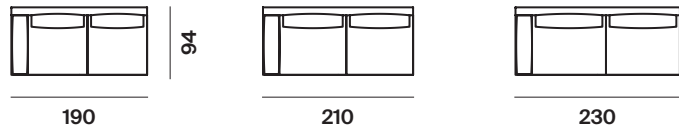

laterali dx side elements rh

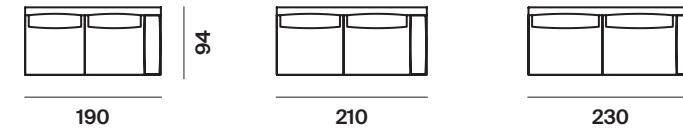

penisola sx chaise longues lh

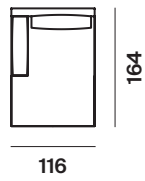

penisola dx chaise longues rh

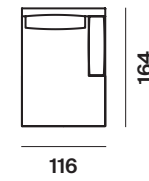

meridienne angolo sx corner dormeuse lh

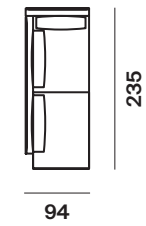

meridienne angolo dx corner dormeuse rh

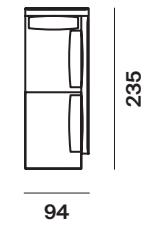

pouf footstool

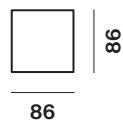

Biggie

design
Luca Nichetto

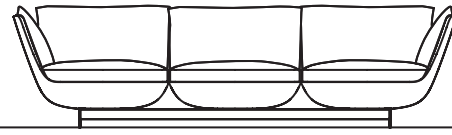
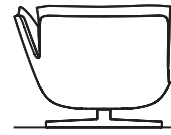

altezza	height	77 cm
altezza seduta	seat height	43 cm
altezza bracciolo	armrest height	77 cm
profondità	depth	94 cm
profondità seduta	seat depth	65 cm

seduta centrale footrest



centrale basso central element

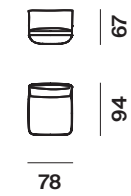

centrale alto central element

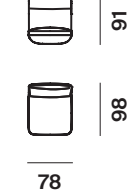

laterale basso sx side element lh



laterale basso dx side element rh



laterale alto sx side element lh



laterale alto dx side element rh



tavolino coffee tables

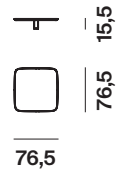

piedi feet

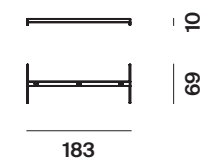
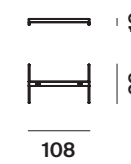

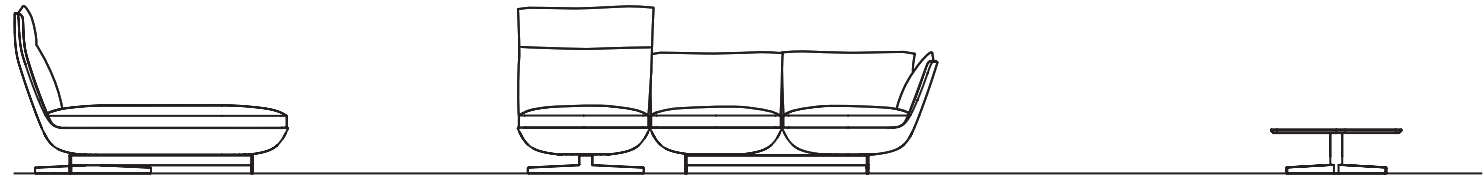

altezza	height	101 cm
altezza seduta	seat height	43 cm
altezza bracciolo	armrest height	77 cm
profondità	depth	94 cm
profondità seduta	seat depth	65 cm
altezza tavolino	coffee tables height	26,5 cm

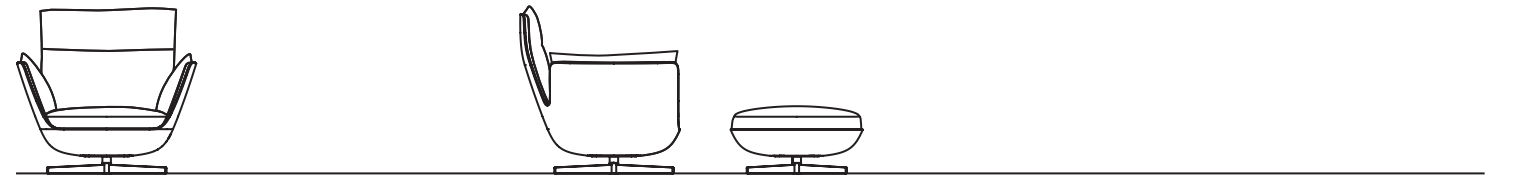

altezza	height	101 cm
altezza seduta	seat height	43 cm
altezza bracciolo	armrest height	77 cm
larghezza seduta	seat width	54 cm
profondità	depth	98 cm
profondità seduta	seat depth	65 cm
altezza pouf	pouf height	43 cm

penisola
chaise longues

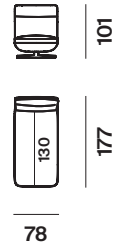

tavolino
coffee tables

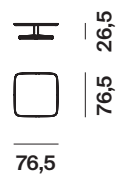

poltrona
armchair



poggiapiedi
footrest



T-Pad

design
Matteo Ragni

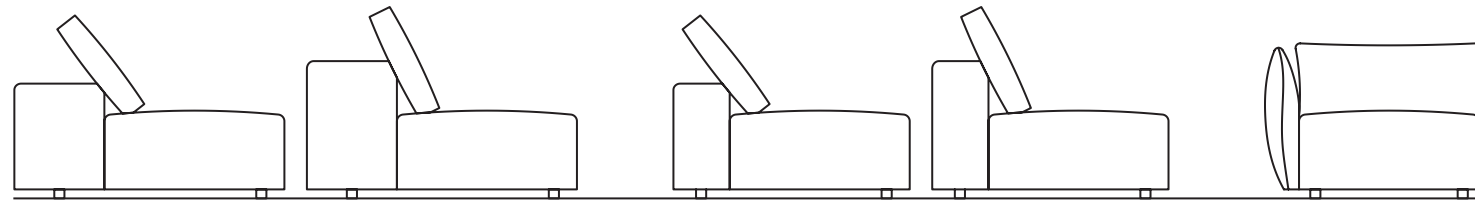

T-Pad ha una struttura in legno multistrato, massello di pioppo e agglomerato di particelle di legno con cuscineria in poliuretano espanso a quote differenziate, fibra di poliestere di grammatura differenziata con rivestimento in tessuto completamente sfoderabile.

The T-Pad structure is in laminated wood, solid poplar and chipboard agglomerate with cushions in polyurethane foam of different densities and polyester fibre of different weights with completely removable upholstery fabric.

altezza	height	70 cm
altezza seduta	seat height	40 cm
altezza bracciolo	armrest height	52 - 62 cm
profondità	depth	95/105/120 cm
profondità seduta	seat depth	80 cm

sedute seats

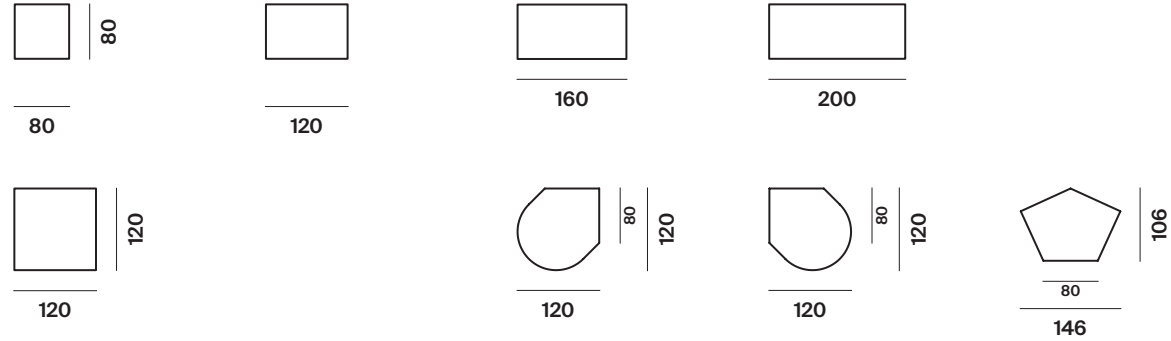

braccioli appoggio h 52 cm free standing armrest h 52 cm

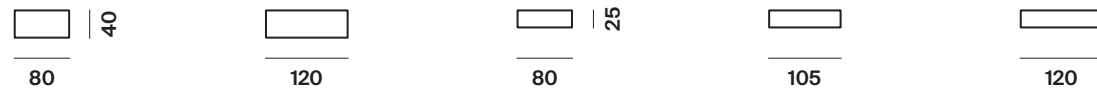

braccioli appoggio h 62 cm free standing armrest h 62 cm

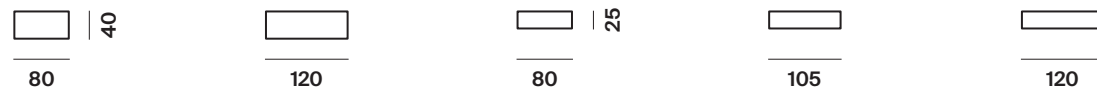

bracciolo schienale armrest backrest

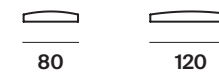

cuscino schienale back cushion

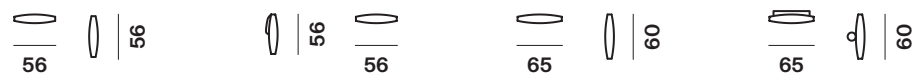

rollò rollò

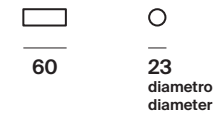

fabric Simi E02
col. 054 cat. Must

Quarto
tavolini coffee tables



Harold

design
Robin Rizzini

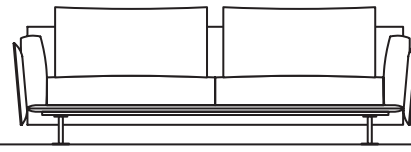
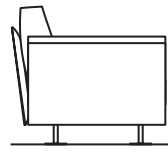

altezza	height	84 cm
altezza seduta	seat height	43 cm
altezza bracciolo	armrest height	66 cm
profondità	depth	94 cm
profondità seduta	seat depth	65 cm

divano / seduta con cuscini separati sofa / two separate seat cushions

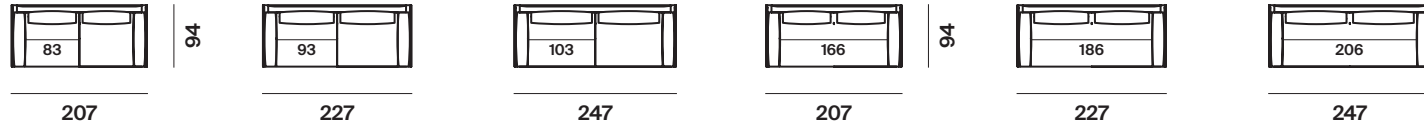

divano / seduta con cuscino intero sofa / one single seat cushion

lateralì sx side elements lh

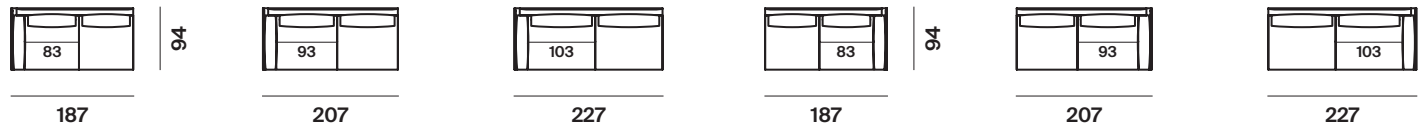

lateralì dx side elements rh

penisola sx chaise longues lh

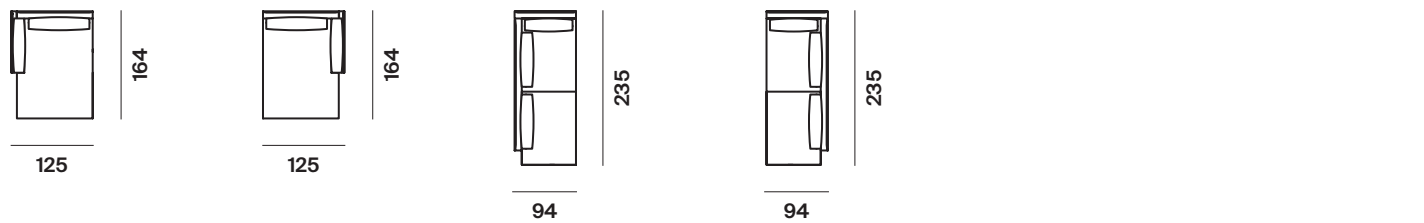

penisola dx chaise longues rh

meridienne sx meridienne lh

meridienne dx meridienne rh

pouf footstool

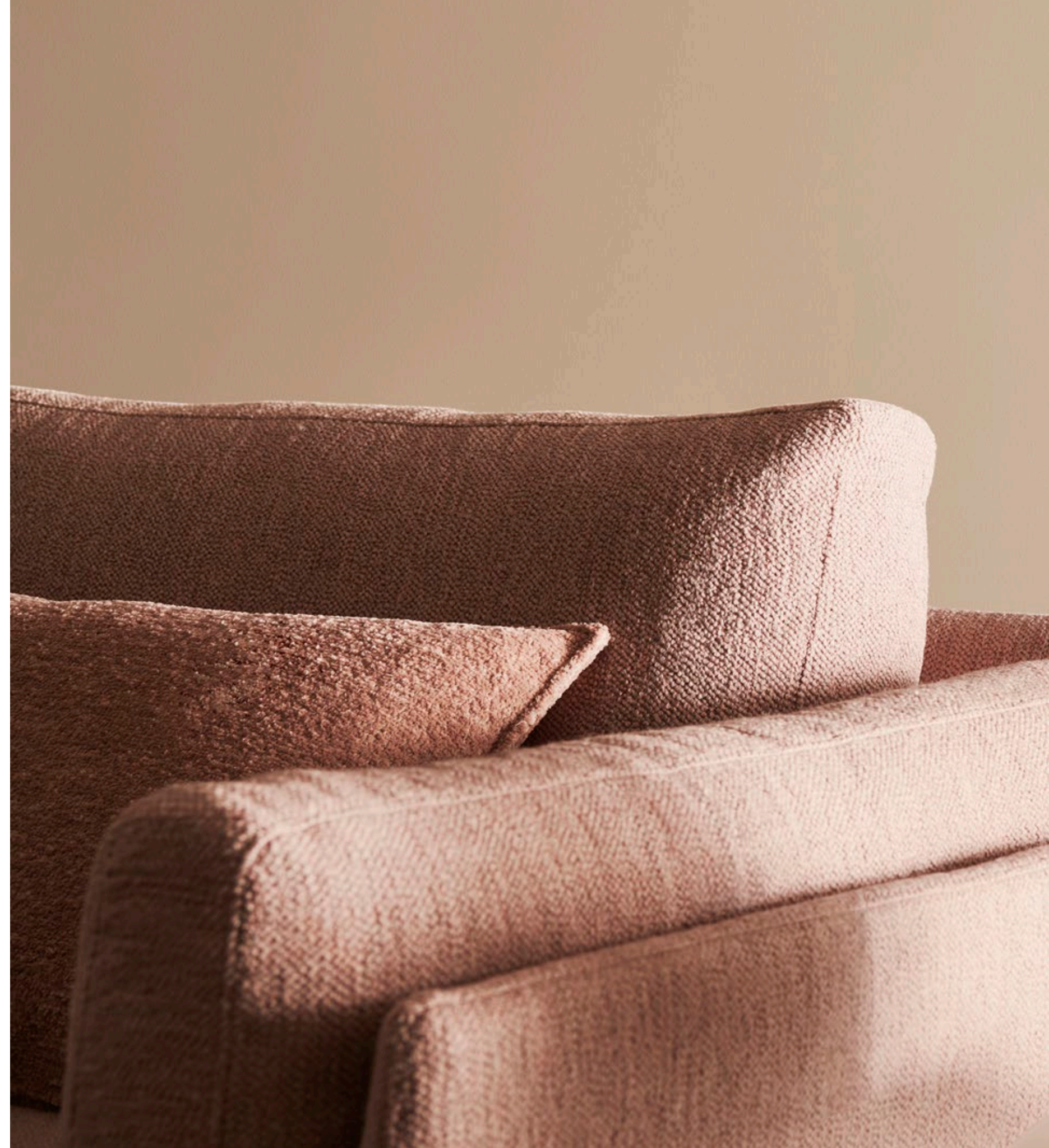
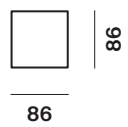

Wing

design
Tiziano Carneletto

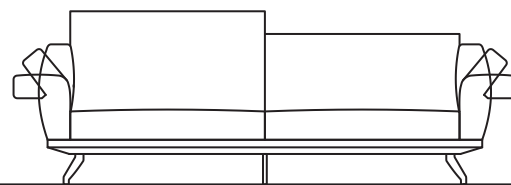
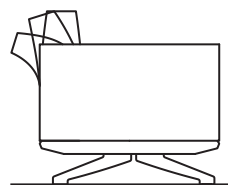

Il segreto di Wing sono il bracciolo e lo schienale regolabili per cambiare posizione. Piedi in alluminio spazzolato o laccati nero opaco.

The secret of Wing is the adjustable armrest and backrest for a change in position. Feet in brushed aluminium or with matt black lacquer finish.

altezza	height	92–80 cm
altezza seduta	seat height	42 cm
altezza bracciolo	armrest height	65 cm
profondità	depth	96–112 cm
profondità seduta	seat depth	73 cm

divani sofa

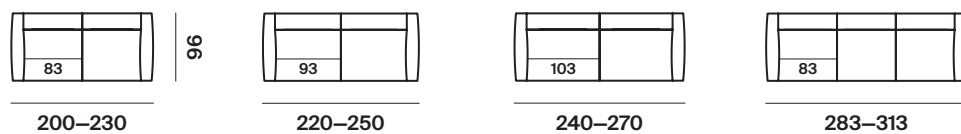

lateralì sx side elements lh

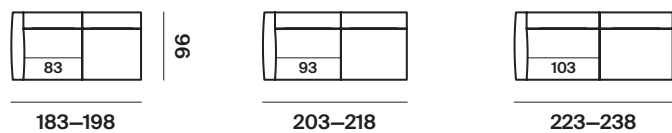

lateralì dx side elements rh

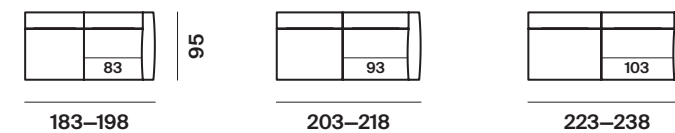

penisola sx chaise longues lh

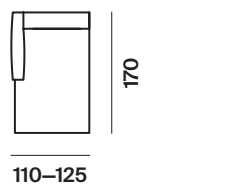

penisola dx chaise longues rh

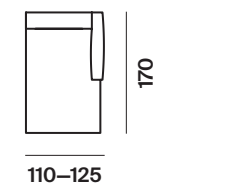

meridienne sx meridienne lh

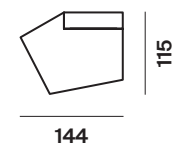

meridienne dx meridienne rh

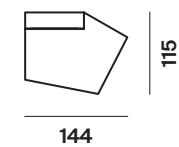

pouf footstool

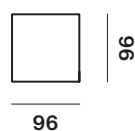



Nubes

design
Studio Viganò

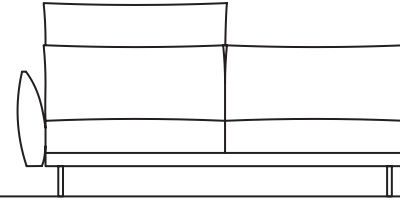
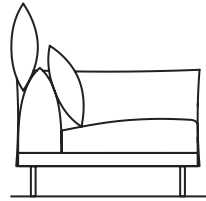

In Nubes spiccano il cuscino di seduta a doppia densità differenziata ricoperto da materassino di piuma d'oca e lo schienale con movimento up and down in metallo e cinghia elastica rivestita di gomme a doppia densità.

Striking features in Nubes are the double density seat cushion with goose feather wrap, the metal up-and-down movement mechanism of the backrest and elastic webbing covered with double density foam.

altezza	height	80–102 cm
altezza seduta	seat height	42 cm
altezza bracciolo	armrest height	68 cm
profondità	depth	105 cm
profondità seduta	seat depth	60–73 cm

divani sofa

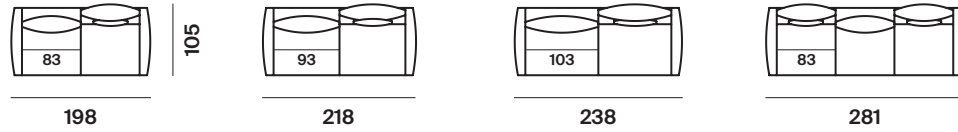

laterali sx side elements lh

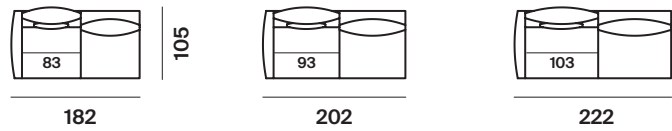

laterali dx side elements rh

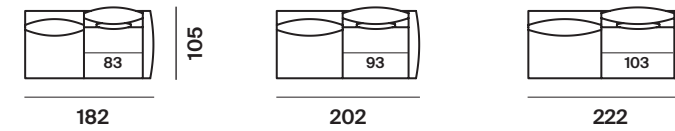

penisola sx chaise longues lh

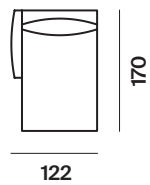

penisola dx chaise longues rh

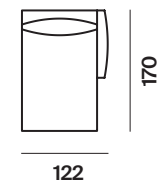

pouf footstool

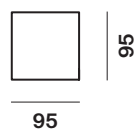

T-Time

design
Matteo Ragni

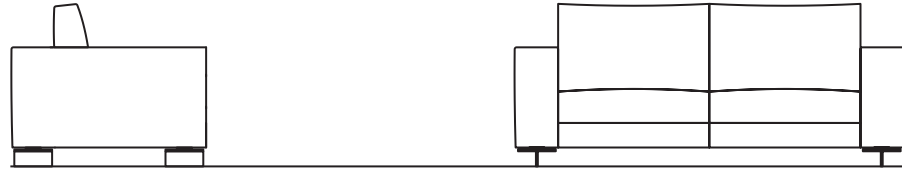

Struttura in massello, multistrato e fibra di legno. Molleggio con cinghie elastiche. I piedi in alluminio spazzolato o laccato nero a forma di T sono l'appoggio che solleva T-Time, aggiungendo un tocco di leggerezza.

Structure in solid wood, multilayer plywood and wood fibre. Elastic webbing. T-Time rests on T-shaped feet in brushed aluminium or with black lacquer finish, giving a refined touch.

altezza	height	86 cm
altezza seduta	seat height	40 cm
altezza bracciolo	armrest height	63 cm
profondità	depth	103 cm
profondità seduta	seat depth	60 cm

divani sofa

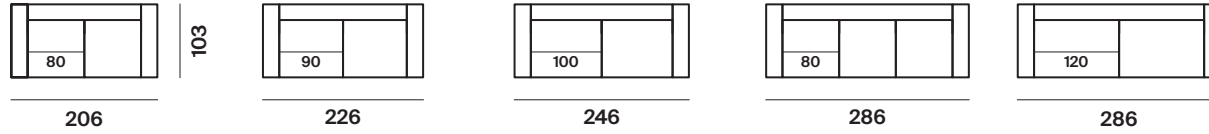

laterali sx side elements lh

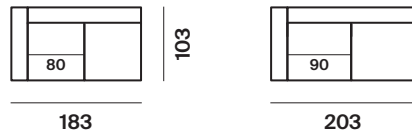

laterali dx side elements rh

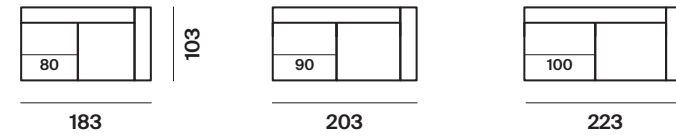

pensole sx chaise longues lh

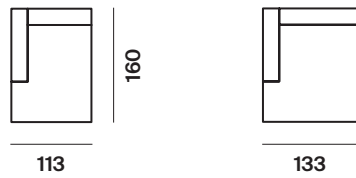

pensole dx chaise longues rh

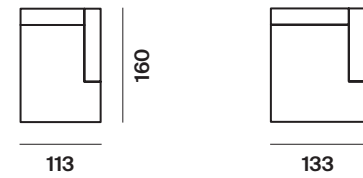

meridienne sx meridienne lh

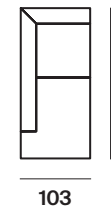

meridienne dx meridienne rh

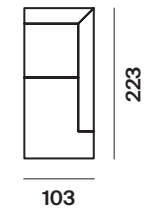

penthouse sx penthouse lh

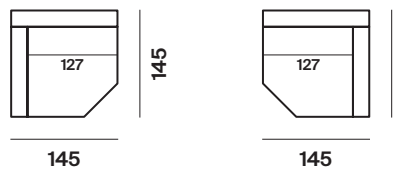

penthouse dx penthouse rh

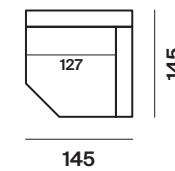

pentangolo pentangolo

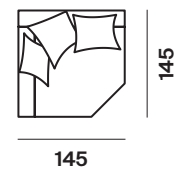

pouf footstool



cuscini schienale back cushions

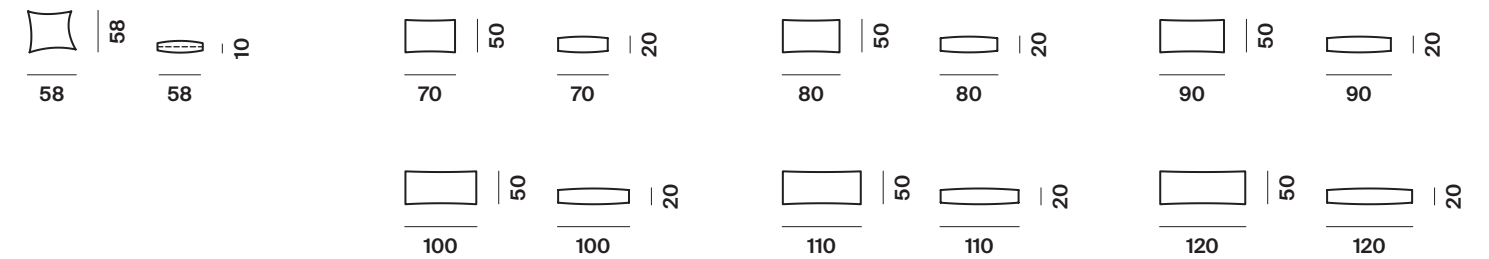



Avenue

design
Tiziano Carnieletto

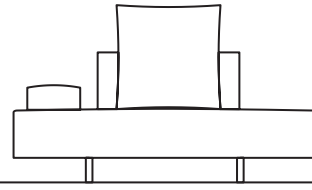
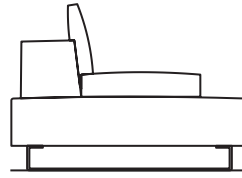

Struttura in massello e multistrato imbottita con gomme a densità differenziate. Schienali mobili in metallo, MDF e gomma. Piedi in metacrilato o metallo laccato nero. Cuscini in piuma.

Structure in solid wood and multilayer plywood padded with different density foam. Movable backrests in metal, MDF and foam. Feet in methacrylate or metal with black lacquer finish. Feather cushions.

altezza massima	height max	88 cm
altezza seduta	seat height	39 cm
altezza bracciolo	armrest height	52 cm
profondità	depth	125/105 cm

sedute seats

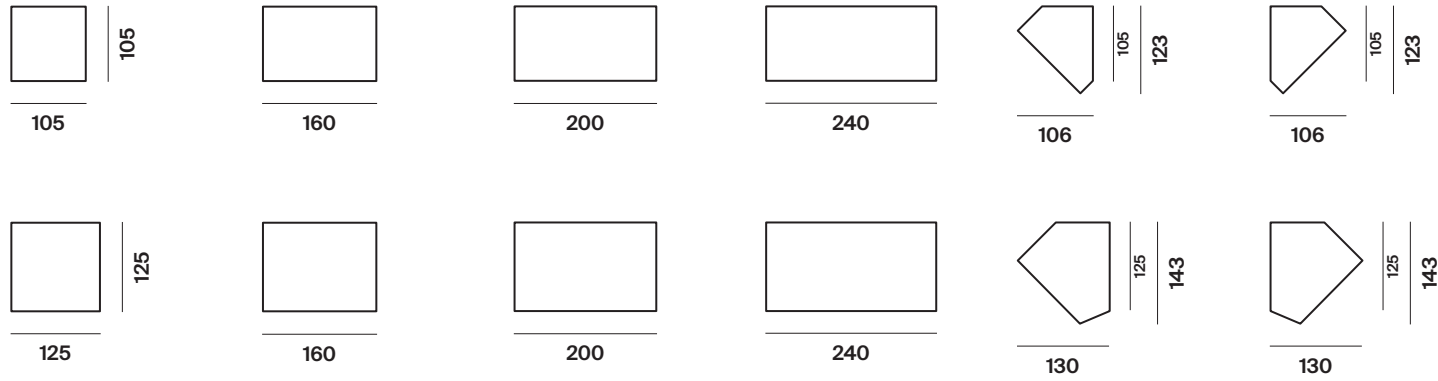

bracciolo appoggio free standing armrest

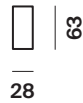

schienale appoggio free standing back frame



cuscinio schienale quadrato square back cushion



cuscinio schienale back cushion



rollò rollò

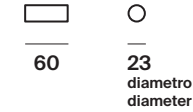

Balmoral

design
Cairoli & Donzelli

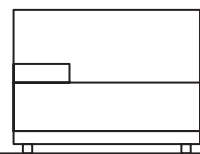
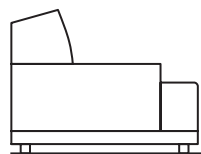

Componibile e completamente sfoderabile, Balmoral ha una struttura in legno multistrato, massello e fibra di legno, sedute e schienali in gomme a densità differenziata. Piedi in ABS a scomparsa.

Modular, with fully removable covers, Balmoral has a structure in multilayer plywood, solid wood and wood fibre, seats and backrests in different density foam. Hidden ABS feet.

altezza	height	77 cm
altezza seduta	seat height	38 cm
altezza bracciolo	armrest height	48 cm
profondità	depth	100 cm
profondità seduta	seat depth	67 cm

lateralì sx side elements lh

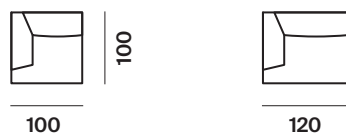

lateralì dx side elements rh

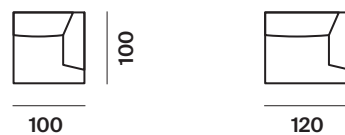

centralì central elements



angolo corner

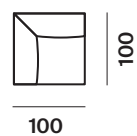

pouf footstool

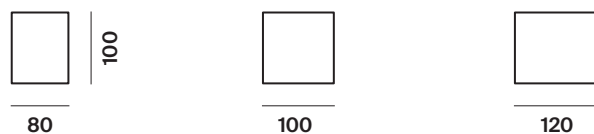

Newport

design
R&D Twils

fabric Pure D57
col. 001 cat. D

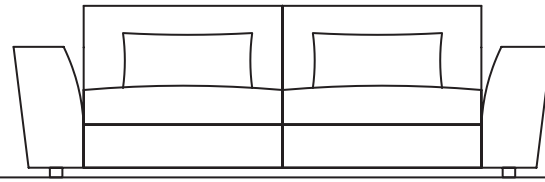
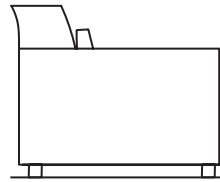

La forza di un divano la cui modularità e stile senza tempo lo rendono perfetto sia per un ambiente classico che per uno contemporaneo.

A sofa which, thanks to its modularity and timeless style, is perfectly at home in either a classical or contemporary room.

altezza	height	80 cm
altezza seduta	seat height	43 cm
altezza bracciolo	armrest height	61 cm
profondità	depth	98 cm
profondità seduta	seat depth	59 cm

divani sofa

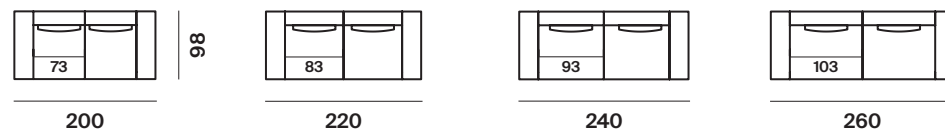

lateralì sx side elements lh

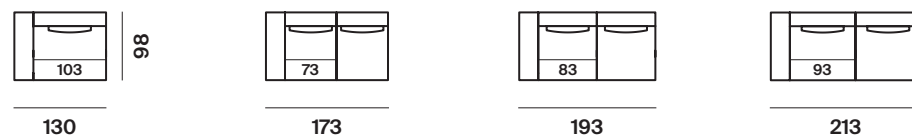

lateralì dx side elements rh

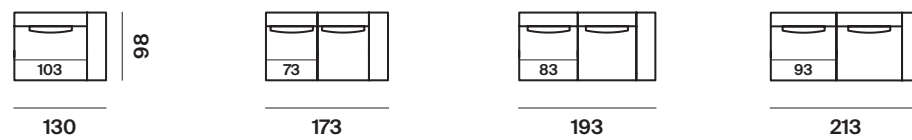

angolo corner

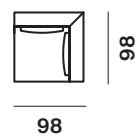

penisola sx chaise longues lh

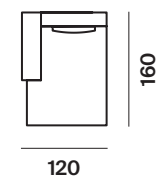

penisola dx chaise longues rh

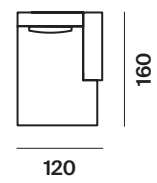

pouf footstool



Antibes

design
R&D Twils

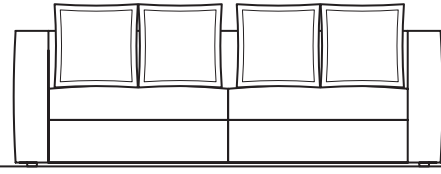
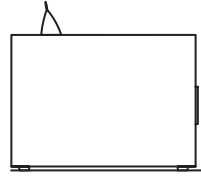

Un divano per chi ama un linguaggio moderno e rassicurante ma non vuole rinunciare a una presenza decisa, in grado di distinguersi.

A sofa for anyone who loves a modern, reassuring style but still wants a standout piece that catches the eye.

altezza	height	80 cm
altezza seduta	seat height	43 cm
altezza bracciolo	armrest height	69 cm
profondità	depth	95 cm
profondità seduta	seat depth	65 cm

divani sofa

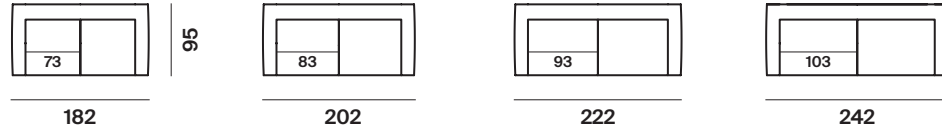

lateralì sx side elements lh

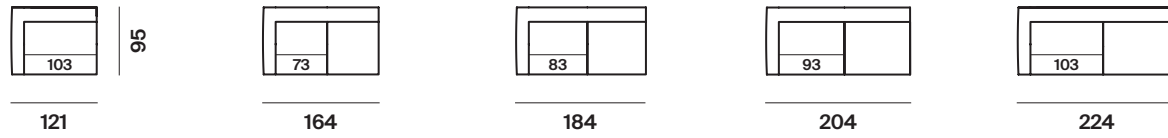

lateralì dx side elements rh

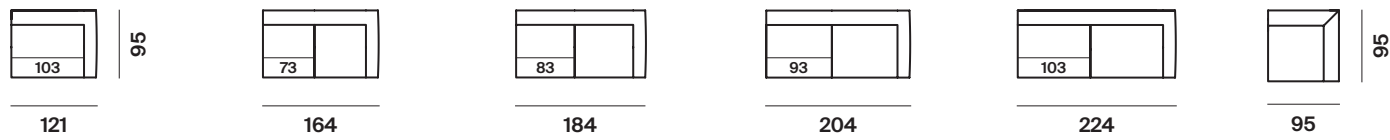

penisola sx chaise longues lh

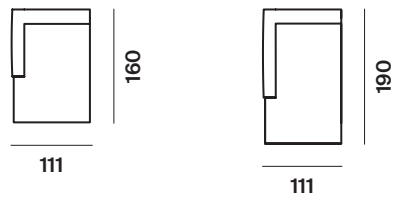

penisola dx chaise longues rh

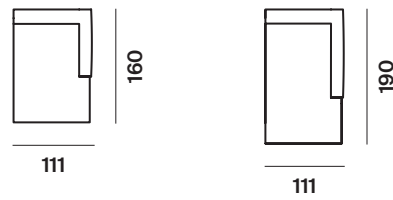

pouf footstool

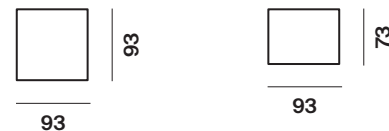

cuscinì schienale back cushions

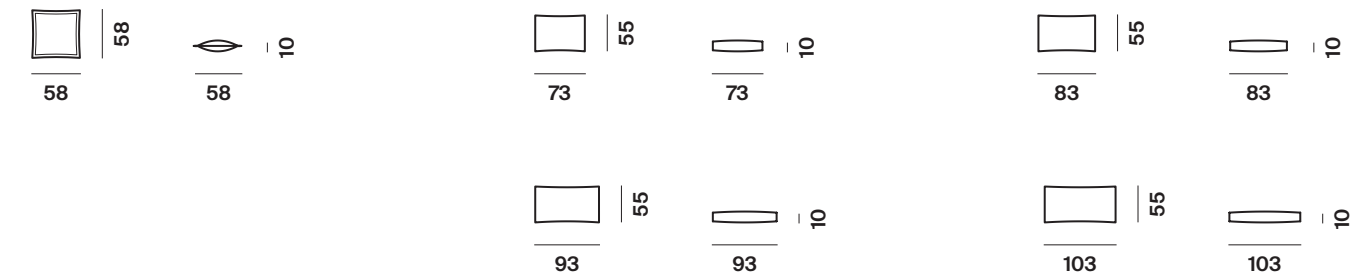

Ascot

design
Tiziano Carneletto

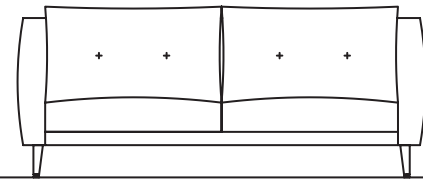
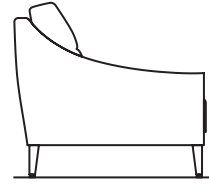

Un inno alla leggerezza e un omaggio agli anni '50, con le curve morbide che rimandano a un immaginario di benessere e serenità, amplificato dalla base a piedini o a slitta.

A tribute to lightness and the Fifties, with soft curves which convey feelings of calm and wellbeing, reiterated in the feet or sled base.

altezza	height	90 cm
altezza seduta	seat height	43 cm
altezza bracciolo	armrest height	55 cm
profondità	depth	101 cm
profondità seduta	seat depth	60 cm

divani sofa

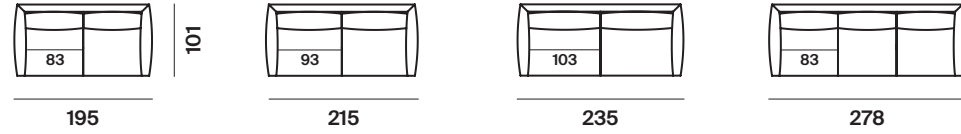

laterali sx side elements lh

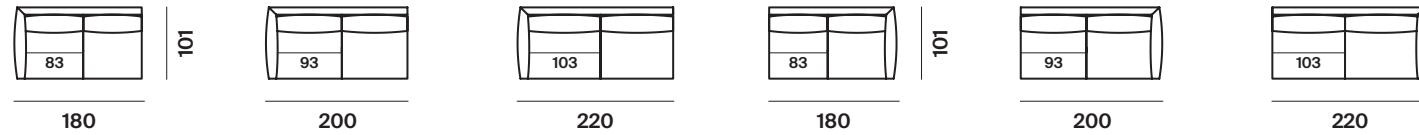

laterali dx side elements rh

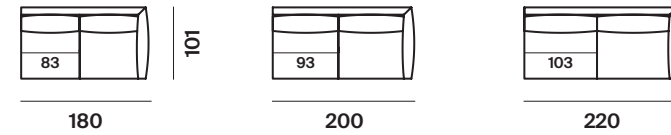

penisola sx chaise longues lh

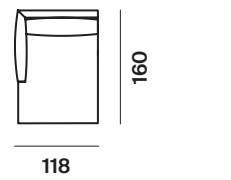

penisola dx chaise longues rh

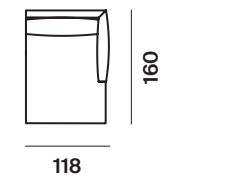

poltrone armchair

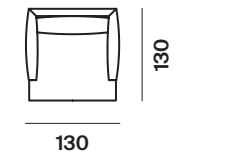
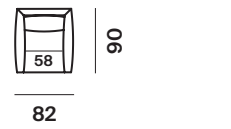

pouf footstool

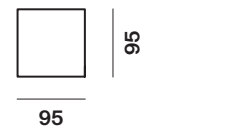

piede slitta sled base
Black Nichel



piede slitta sled base
Oro



piede puntale brunito
burnished cone-shaped feet
Tip Black Nichel



piede puntale brunito
burnished cone-shaped feet
Tip Oro



PoLet

design
Achille Castiglioni

poltrona
armchair

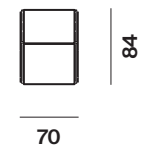

letto
bed

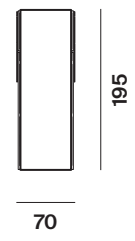

Ironia e gioco in questa poltrona che diventa letto con un gesto semplicissimo. Un arredo un po' nomade e versatile per portare funzionalità e sorriso in casa.

This armchair, which is both ironic and playful, becomes a bed in a single, intuitive movement. A versatile, nomadic piece of furniture that is highly practical and will bring a smile to anyone's face.

altezza	height	175 cm
altezza schienale	back height	137 cm
altezza seduta	seat height	44 cm
altezza bracciolo	armrest height	63 cm
larghezza seduta	seat width	65 cm
profondità seduta	seat depth	48 cm
profondità	depth	84 cm



altezza	height	63 cm
altezza seduta	seat height	44 cm
altezza bracciolo	armrest height	63 cm
larghezza seduta	seat width	65 cm
profondità	depth	195 cm

fabric Natural 679
col. 093 cat. D





Moon

design
Matteo Ragni

poltrona
armchair

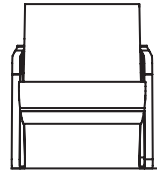
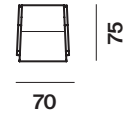

Il sedile e lo schienale, uniti e simmetrici, si appoggiano su una struttura di acciaio: come un unico filo di metallo che percorre tutta la struttura, regalando leggerezza inattesa e comfort alla morbida seduta.

The seat and backrest, in one symmetrical piece, are supported by a steel frame, which runs like a single metal thread along the entire structure, conferring upon the soft seat an unexpected gracefulness and comfort.

altezza	height	82 cm
altezza seduta	seat height	43 cm
altezza bracciolo	armrest height	59 cm
larghezza seduta	seat width	56 - 53 cm
profondità	depth	75 cm
profondità seduta	seat depth	48 cm



Etan

design
Robin Rizzini

poltrona
armchair

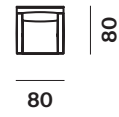

altezza	height	84 cm
altezza seduta	seat height	43 cm
altezza bracciolo	armrest height	60 cm
larghezza seduta	seat width	60 cm
profondità	depth	80 cm
profondità seduta	seat depth	56 cm



Rica

design
Beatriz Sempere

poltrona
armchair

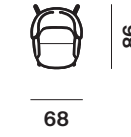

Avvolgente, quasi sospesa, la poltrona che meschia materiali diversi, perfetta per chi ricerca l'eleganza della forma.

Embracing, almost floating, the Rica armchair is made of different materials and is ideal for anyone who seeks elegance in their shapes.

altezza	height	78 cm
altezza seduta	seat height	43 cm
altezza bracciolo	armrest height	58 cm
larghezza seduta	seat width	52 cm
profondità	depth	86 cm
profondità seduta	seat depth	58 cm



Adele

design
Antonio De Marco

poltrona
armchair

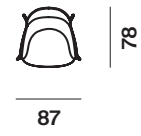

Solida e tenace, Adele poggia sulle gambe pensate come un esoscheletro per accogliere la scocca curvata della seduta e dello schienale. Il piede, personalizzabile, la rende unica.

Solid and tenacious, the legs of the Adele armchair are designed to look like an exoskeleton, supporting the curved frame of the seat and backrest. The feet can be customised, making it unique.

altezza	height	97 cm
altezza seduta	seat height	45-42 cm
altezza bracciolo	armrest height	63 cm
larghezza seduta	seat width	60-53 cm
profondità	depth	78 cm
profondità seduta	seat depth	55 cm



T-Vision

design
Matteo Ragni

poltrona
armchair

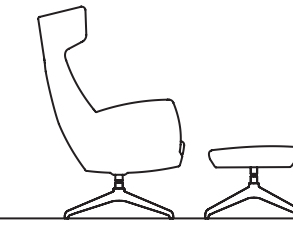
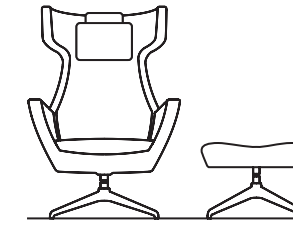
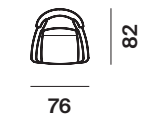

pouf
footstool

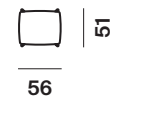

Struttura in metallo affogata su schiumato poliuretano e ricoperto in gomma viscoelastica anatomica. Piede in alluminio spazzolato o laccato nero opaco.

Metal structure wrapped in polyurethane foam and covered in anatomical viscoelastic foam. Feet in brushed aluminium or with matt black lacquer finish.

altezza	height	112 cm
altezza seduta	seat height	42 cm
altezza bracciolo	armrest height	66 cm
larghezza seduta	seat width	52 cm
profondità	depth	82 cm
profondità seduta	seat depth	52 cm
altezza pouf	footstool height	38 cm



Chocolat

design
Tiziano Carnieletto

poltrona
armchair

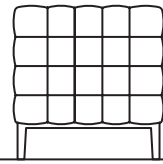
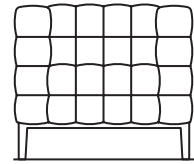
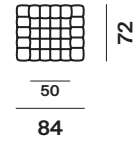

Struttura in multistrato e fibra di legno imbottita da gomme a densità differenziate. Piedi o base girevole in grigio grafite.

Structure in multilayer plywood and wood fibre padded with different density foam. Feet or swivel base in graphite grey.

altezza	height	73 cm
altezza seduta	seat height	46 cm
altezza bracciolo	armrest height	73 cm
larghezza seduta	seat width	50 cm
profondità	depth	72 cm
profondità seduta	seat depth	52 cm



fabric Sade E01
col. 626 cat. K

Jolie

design
Tiziano Carnieletto

poltrona
armchair

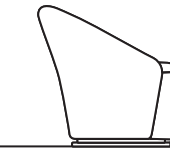
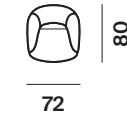

Disponibile con i piedi in ABS a scomparsa o con base girevole, sempre a scomparsa.

Available with hidden ABS feet or swivel base, always hidden.

altezza	height	76 cm
altezza seduta	seat height	44 cm
altezza bracciolo	armrest height	60 cm
larghezza seduta	seat width	52 cm
profondità	depth	80 cm
profondità seduta	seat depth	55 cm



Cura e fattore umano Care and human factor



È un sentiero stretto e pieno di emozioni quello che inizia con la seduzione e porta all'innamoramento. Lungo la strada ci sono la cura e il fattore umano: dedizione, passione e attenzione per l'altro sono gli ingredienti che costruiscono un rapporto e diventano la sua vera ricchezza.

Con un divano e una poltrona funziona allo stesso modo. C'è il fascino di un'immagine, la bellezza di un oggetto di design che si offre in vetrina per il piacere degli occhi. Ma che cosa resterebbe se ci fermassimo ad ammirare un lampo, alla suggestione di una scintilla?

Better Living è bellezza oltre il fascino. Se la vetrina cattura e seduce, la conquista avviene durante il momento magico dell'incontro con i nostri divani e le nostre poltrone, a partire dall'attimo in cui proviamo sulla pelle la sensazione del comfort più autentico, frutto dell'aver tradotto ogni scelta progettuale in attenzione per il pubblico.

Una ricchezza che si apprezza con il tatto e l'uso, grazie alla scelta di materie prime pregiate, lavorate da mani esperte e attraverso un knowhow che arriva da un'expertise consolidata nell'universo del benessere e degli imbottiti.

La ricchezza di Better Living è la cura che si rivela nell'attenzione riposta scegliendo le soluzioni più adatte al design dei nostri arredi firmati dai grandi nomi del made in Italy. Le differenti densità delle imbottiture per ottenere ergonomie diverse, una per ogni posa e stile di vita possibile, dal classico all'informale. La precisione dei molleggi e la resistenza delle strutture. L'incastro geometrico delle tessiture alla base di cuscini configurabili all'infinito. Le mani esperte di addetti che lavorano per consegnare al pubblico la quintessenza del comfort. L'amore per la natura che si traduce nel rispetto delle normative ambientali e nell'attenzione alle scelte produttive meno impattanti.

Better Living è una collezione che guarda al futuro con i piedi saldi nel presente. Per questo motivo non potevamo trascurare l'esigenza di preservare la salute del nostro pubblico: tutte le nostre creazioni sono rivestite, prima ancora che col tessuto, con un telino di cotone sanificato.

The path which starts with seduction and leads to falling in love is a narrow, emotional one. En route care and the human factor play a part: devotion, passion and attention for the other are the ingredients on which a relationship is built up and which make it truly strong.

It works in exactly the same way with a sofa or an armchair. There is the allure of an image, the beauty of a design object in a window display that catches the eye. But what would we be actually left with if we stopped to admire a flash of lightning, the suggestion of a spark?

Better Living is beauty beyond allure. While the window display captures and seduces, the conquest takes place during the magic moment of the meeting with our sofas and armchairs, it starts the instant we actually feel the genuine comfort which stems from every design decision having been transformed into consideration for customers.

It is a value that is appreciated through touching and using the object, which has been achieved through the selection of superior raw materials crafted by skilled hands and the know-how from years of expertise in the world of wellbeing and of padded, upholstered furniture.

The true value of Better Living lies in the care and attention given to choosing the solutions most suited to the design of our furniture created by renowned Italian designers. The different densities of the paddings to meet different ergonomic requirements, one for each possible posture and lifestyle, from classic to informal. The precision of the springing/webbing and the strength of the structures. The geometric interlocking weave design of cushions offering countless possibilities of arrangement. The expert hands of workers who toil to give end users the ultimate in terms of comfort. The love for nature, which translates into compliance with environmental legislation and attention paid to production decisions intended to lower impact.

Better Living is a collection which looks to the future but with feet firmly planted in the present. That is why we could not ignore the need to protect the health of our customers: all our creations are wrapped in a fine layer of sanitised cotton beneath the fabric upholstery.



Twils®

I prodotti presenti in questo volume sono progettati e realizzati in Italia secondo i più alti standard qualitativi, nella tutela dell'ambiente, dei diritti e della salute dei lavoratori.

The products in this catalogue have been designed and made in Italy to the highest quality standards, while protecting the environment as well as the rights, health and safety of workers.

via degli Olmi 5
31040 Cessalto (TV) Italy

T +39 0421 469011 R.A.
T +39 0421 469090 uff. comm.
T +39 0421 469050 uff. sped.
F +39 0421 327916

info@twils.it
©  @mytwils

twils.it

communication director:
Vilma Carnieletto

art direction:
Matteo Ragni

styling:
Ilaria Bacciocchi Studio
Vanessa Pisk Studio

photo:
Max Rommel

graphic design:
Alessandro Boscarino
Valerio Aprigliano

text intro:
Laura Traldi
Paolo Casicci

text Biggie:
Elisa Massoni

postproduction:
Studio Dilux

print:
Grafiche Antiga

thanks to:
Amini Carpets
Artemide
Astep
Atelier Areti
Axolight
Battilossi
cc-tapis
Cuore Carpenito
Flos
Foscarini
Golran
Jannelli&Volpi
Karpeta
Lighting collections by Penta
Luceplan
Martinelli Luce
MMairo
Mohebban
NUDE Glass
Oluce
Pallucco
Salvatori Marmi
Santa&Cole
Sirecom
Tato
Tera



**Le immagini e i
dati contenuti nel
presente catalogo
sono da ritenersi
indicativi e pos-
sono subire varia-
zioni anche senza
alcun preavviso.**

The images and
data contained in
this catalogue are
provided for illus-
trative purposes
only and can be
changed without
notice.