



Miniforms is a furniture designer based in Venice.

Or rather. Miniforms is a bizarre kind of: she wears colorful outfits with strange shapes and you can easily find her talking with young talented designers.

Her motto is “Making Craftsmanship Last” because she believes in uniqueness: hands do the most part and machines help to keep up with the modern manufacturing process. She is even sensitive to environmental matters: a strong social responsibility spurs her to manufacture locally based on circular economy thinking, from the choice of materials to suppliers who share her same aims.

06—79
SEDIE
Chairs — Chaises — Stühle — Sillas

Brulla 08
Claretta 12
Claretta Bold 20
Pelleossa 24
Diverge 30

Tube 36
Valerie 40
Iola 44
Mula 50
Mariolina 54

Leda 64
Dumbo 68
Pelè 72
Marino 74

80—95
SGABELLI
Stools — Tabourets — Hocker — Taburetes

Vitos 82
Ferrovitos 86

Milk 88
Pezzo 92

96—141
IMBOTTITI
Upholstered seating — Meubles rebourrés — Polstermöbel — Tapizados

Colony 98
Sergia 104
Boterina 108
Botera 112

Botera Pouf 116
Botera Sofa 118
Poltrona Lem 126
Divano Lem 128

Louise 132
Diplopie 134
Furoshiki 136

142—153
LETTI
Beds — Lits — Betten — Camas

Shiko Wien 144
Shiko Wonder 149
Shiko Magnum 152

154—185
LAMPADE
Lamps — Lampes — Lampen — Lámparas

Ozz 156
Ozz Floor 160
Ozz Wall 164
Ozz Desk 168

Ozz Wall S 170
Eclipse 174
Dent 176
Tora 178

Kiki 180
Slope 182

186—213
ACCESSORI
Accessories — Accessoires — Wohnaccessoires — Accesorios

Coque 188
Les Brothers 192
Benvenuto 196

Cigales 198
Colony Screen 202
Game of Trust 204

Bubble 206
Caio 208
Chiodo 210



We see them as an icon of personality: we made each one with a strong character that can reflect your attitude or simply represent your sense of aesthetics.



BRULLA

design
year

Skrivo
2021





Ispirata alle sedie austriache del Novecento, Brulla è una sedia in legno impilabile. L'estetica grafica che la definisce è data dall'incontro di forme curve e lineari, risolte in uno spirito identitario e minimalista: lo slancio dinamico dello schienale e gambe posteriori incontra una seduta leggermente inclinata in paglia di Vienna, compensata armonicamente dalle gambe anteriori. Il gusto retrò si confronta così con i particolari profili delle gambe i quali, assieme ad altri discreti dettagli, arricchiscono Brulla del linguaggio contemporaneo.

EN Inspired by 20th-century Austrian chairs, Brulla is a stackable wooden seat. Its defining aesthetic is given by the juxtaposition of curves and straight lines, creating a strong sense of identity and minimalist spirit: the dynamic momentum of the backrest and back legs meets a slightly tilted cane-webbed seat, balanced harmoniously by the front legs. Thus, its retro taste combines with the distinctive profile of the legs, which, together with other discreet details, enrich Brulla with contemporary codes.

FR S'inspirant des chaises autrichiennes du XXe siècle, Brulla est une chaise en bois empilable. L'esthétique qui la définit naît de la rencontre entre des formes courbes et linéaires, résolue dans un esprit identitaire et minimaliste : l'élan dynamique du dossier et des pieds arrière rencontre une assise cannée légèrement inclinée, harmonieusement équilibrée par les pieds avant. Le goût rétro se confronte ainsi avec le profil particulier des pieds qui, avec d'autres détails discrets, donnent à Brulla un accent contemporain.

DE Brulla, ein stapelbarer Stuhl aus Holz, orientiert sich im Design an den österreichischen Thonet Stühlen des vorigen Jahrhunderts. Seine ästhetische Grafik entsteht aus der Verbindung gebogener und linearer Formen, die ihm eine minimalistische Identität verleihen: Der dynamische Schwung von Rückenlehne und Hinterbeinen trifft auf eine leicht schräge Sitzfläche aus Wiener Geflecht, die von den Vorderbeinen harmonisch ausgeglichen wird. Retro-Stil misst sich mit dem besonderen Profil der Beine, die zusammen mit anderen diskreten Details den Stuhl Brulla durch einen Ausdruck im Zeitgeist bereichern.

ES Inspirada en las sillas austriacas del siglo pasado, Brulla es una silla de madera apilable. La estética gráfica que la define surge del encuentro de formas curvas y rectas, resueltas en un espíritu identitario y minimalista: la curva dinámica del respaldo y las patas traseras se encuentra con un asiento de rejilla ligeramente inclinado, compensado armónicamente por las patas delanteras. El gusto retro contrasta así con los peculiares perfiles de las patas que, junto a otros discretos detalles, enriquecen las sillas Brulla con el lenguaje contemporáneo.



CLARETTA

design
year

Florian Schmid
2015





Dal carattere parigino e ispirata alla sedia da bistrot tradizionale, Claretta è una sedia snella e accuratamente pettinata. È semplice ma dai dettagli importanti: le gambe, tornite, incontrano con decisione lo schienale che si inclina leggermente verso l'alto per garantire il massimo comfort. Impilabile per cinque, è disponibile anche con braccioli e nella versione sgabello.

EN Parisian in character and drawing its inspiration from the traditional bistro chair, Claretta appears as a slender, impeccably groomed seat. The design is simple yet sports essential details, such as the assertive way in which the turned legs join the backrest, which tilts out slightly towards the top to guarantee the utmost comfort. Stackable up to a height of five, it is also available with armrests and in a stool version.

FR Avec son caractère parisien et s'inspirant de la chaise bistrot traditionnelle, Claretta est une chaise fine et très sage. Elle est simple sans renoncer aux détails importants : les pieds, façonnés au tour, rejoignent avec décision le dossier qui s'incline légèrement vers le haut pour garantir le plus grand confort. Empilable par cinq, elle est également disponible avec des accoudoirs et dans la version tabouret.

DE Pariser Charme in der Tradition von Bistrot-Stühlen, Claretta ist ein schlanker, sehr ordentlicher Sessel. Claretta ist schlicht, aber mit anspruchsvollen Details: die gedrechselten Beine treffen zielbewusst auf die Rückenlehne, die sich für maximalen Komfort oben ein wenig nach außen lehnt. Bis fünf Stück stapelbar, auch erhältlich mit Armlehnen und in der Ausführung als Hocker.

ES De carácter parisino e inspirada en la tradicional silla de bistro, Claretta es una silla ágil y esmeradamente pulcra. Es sencilla pero con detalles importantes: las patas torneadas se unen con decisión al respaldo, que se inclina ligeramente hacia arriba para garantizar el máximo confort. Apilable de cinco en cinco, también está disponible con reposabrazos y en la versión de taburete.



Claretta with armrests
Chair



Claretta
Stool

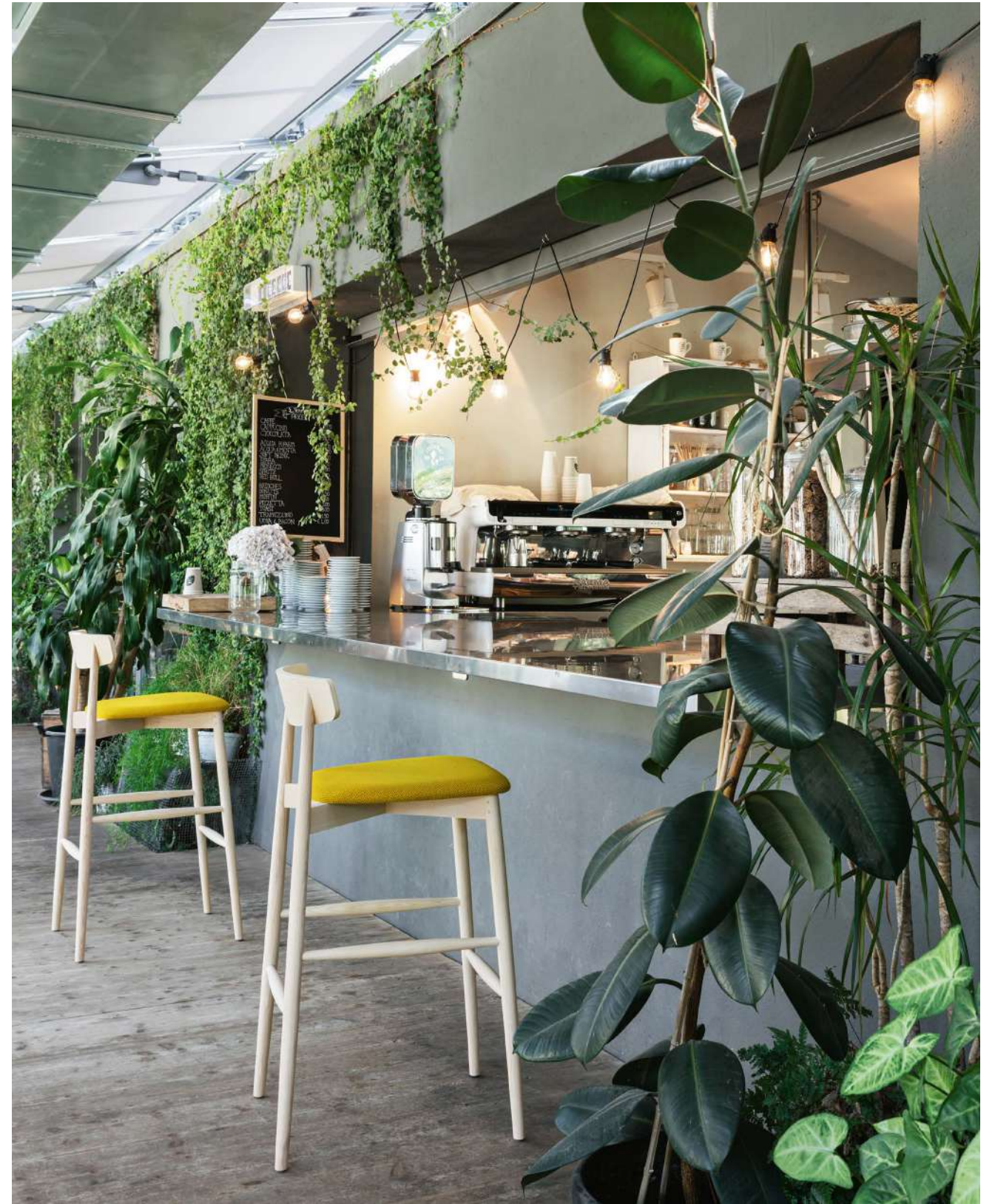

Claretta
Stool



Claretta Bold
Chair

Briscola
Table

CLARETTA BOLD

design
year

Florian Schmid
2017





Claretta è diventata adulta e ha preso inevitabilmente qualche chilo. Niente di preoccupante, non fate quella faccia strana se si chiama Bold. È grossa, formosa e a noi piace così. L'espressione esile degli anni passati, che faceva tenerezza, è diventata scultorea e decisa. Ha la voce alta, da protagonista e forse è un po' egocentrica. Noi però preferiamo definirla carismatica. Si inserisce perfettamente nei tavoli ed è impilabile.

EN Claretta is all grown-up, and has inevitably gained a few kilos. Nothing to worry about, don't pull that face if we call it Bold. It is big, voluptuous, and we like it that way. The slender expression of past years, which we viewed with tenderness, has now grown more sculptural and decisive. It has the loud voice of a protagonist, and is perhaps even a little self-centred. But we prefer to call it charismatic. It fits beautifully with the tables, and is stackable.

FR Claretta est devenue adulte et a pris inévitablement quelques kilos. Rien de préoccupant, ne faites pas cette tête si elle s'appelle Bold. Elle est bien en chair, elle s'assume et nous l'aimons comme ça. La minceur des années passées, attendrissante, est devenue plus résolue et sculpturale. Elle a de la voix, elle sait s'imposer et est peut-être un peu égoцентриque. Nous, nous la trouvons plutôt charismatique. Elle rentre parfaitement sous les tables et est empilable.

DE Claretta ist erwachsen geworden und hat unweigerlich ein paar Pfund zugelegt. Gar nicht beunruhigend, machen Sie nicht so ein Gesicht, nur weil sie Bold heißt. Claretta ist rund und wohlgeformt, aber so gefällt sie uns. Die schlanke Zerbrechlichkeit vergangener Jahre, die uns mit Zärtlichkeit erfüllt hat, ist plastisch und kraftvoll geworden. Die Stimme laut, wie sie einem Protagonisten zusteht, ein wenig egozentrisch. Charismatisch, wie wir lieber sagen. Passt perfekt zu jedem Tisch und ist stapelbar.

ES Claretta se ha hecho adulta e, inevitablemente, ha cogido algunos kilos. Nada preocupante, no pongáis esa cara rara si se llama Bold. Es gruesa y hermosa y a nosotros nos gusta así. La expresión grácil de los años anteriores, que provocaba ternura, se ha vuelto escultural y decidida. Tiene la voz fuerte, de protagonista, y tal vez sea un poco egocéntrica. Aunque nosotros preferimos definirla como carismática. Entra perfectamente bajo las mesas y es apilable.



Pelleossa
Chair

Decapo
Table

PELLEOSSA

design
year

Francesco Faccin
2012

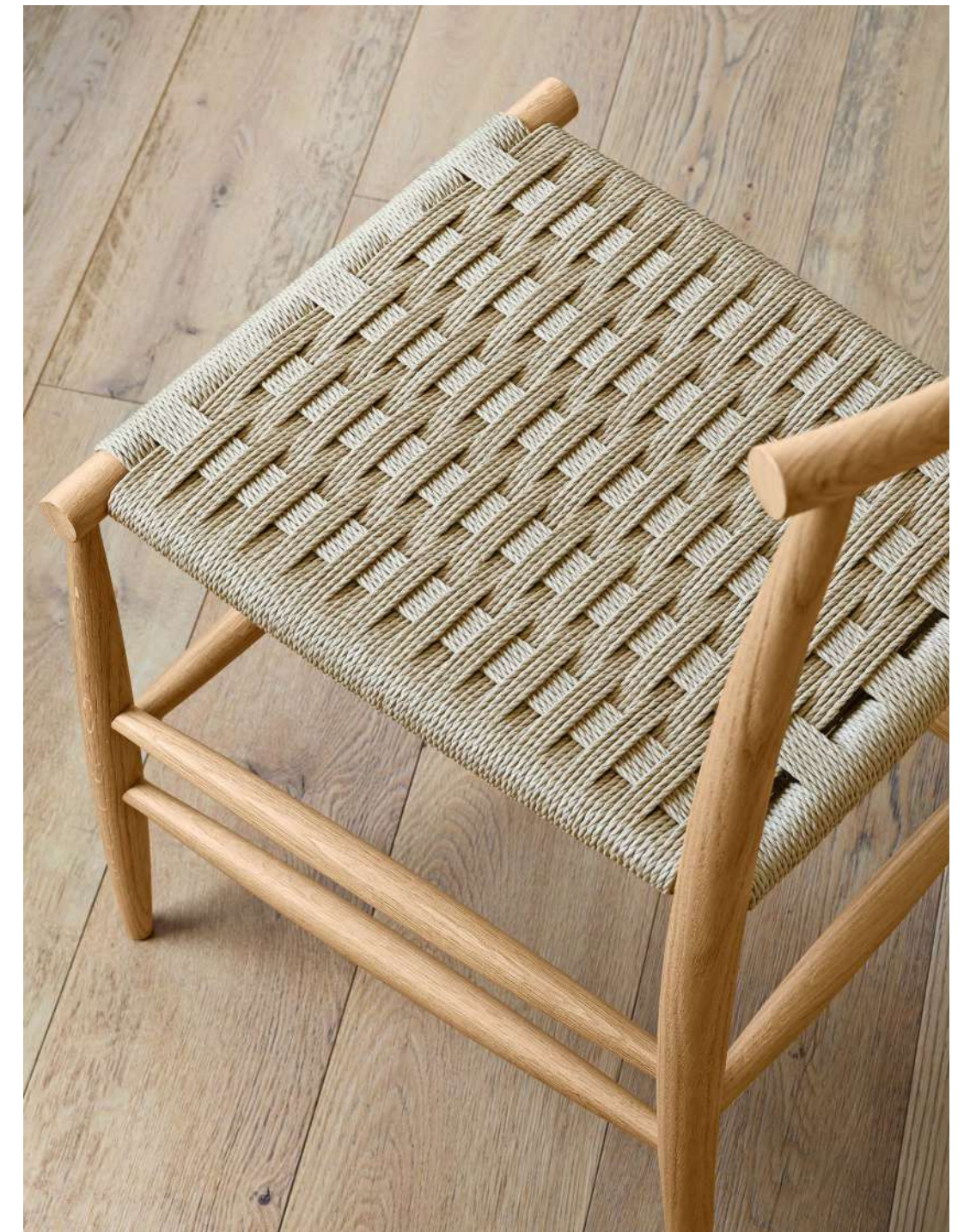



Pelleossa è una sedia eclettica, slanciata, che esprime il suo carattere nei dettagli. Si ispira alle sedie italiane di epoca preindustriale, inserendo l'atteggiamento dell'arte concettuale. Disponibile anche con i braccioli, si completa con le diverse combinazioni della seduta.

EN Pelleossa is a slender, eclectic chair that expresses its character through detail. It is inspired by the Italian chairs of pre-industrial times, sporting the attitude of conceptual art. Also available with armrests, it completes with the different combinations of the seat.

FR Pelleossa est une chaise éclectique, élancée, qui exprime son caractère dans les détails. Elle s'inspire des chaises italiennes de l'époque préindustrielle en ajoutant l'attitude de l'art conceptuel. Également disponible avec accoudoirs, se complète avec les différentes combinaisons de l'assise.

DE Pelleossa ist ein vielseitiger, schlanker Stuhl, der seinen Charakter in den Details zum Ausdruck bringt. Er ist inspiriert von italienischen Stühlen der vorindustriellen Zeit und beinhaltet die Haltung der Konzeptkunst. Der Stuhl ist auch mit Armlehnen erhältlich und wird durch die unterschiedlichen Kombinationen der Sitzfläche vervollständigt.

ES Pelleossa es una silla ecléctica, estilizada, que expresa su carácter en los detalles. Se inspira en las sillas italianas de la época preindustrial mostrando a la vez la actitud del arte conceptual. Está también disponible con reposabrazos, se completa con las distintas combinaciones del asiento.



Pelleossa
Chair

Illo
Table



Pelleossa
Stool



DIVERGE

design
year

Skrivo
2018





Diverge
Stool

Diverge è la nostra proposta di sedia a compasso, dal tono contenuto e senza sbavature. Impara dall'architettura il rispetto per ogni dettaglio, trovando nella perfezione della struttura la propria identità. Diverge raggiunge così un linguaggio distinto e maturo che la porta ad essere applicata in contesti diversi, dal ristorante alla casa, definendo chiaramente il nostro studio nella sedia in legno.

EN Diverge is our idea for a compass chair, in a soft, flawless tone. It draws respect for each detail from architecture, finding its true identity in the perfection of the structure. Diverge thus attains a distinct, mature language that leads it to being applicable to various settings, from the restaurant to the home, clearly defining our studio in this wooden chair.

FR Diverge est notre collection de chaises avec des pieds compas, au style discret et sans bavures. Elle a pris du monde de l'architecture le respect pour tous les détails, en trouvant sa propre identité dans la perfection de la structure. Diverge propose ainsi un langage distinct et mature qui lui donne une place dans des espaces variés, allant du restaurant à la maison privée, en exposant clairement nos recherches dans le domaine de la chaise en bois.

DE Diverge ist unser Kompass mit verhaltenem Farbton und ohne Ausschweifungen. Aus der Architektur wurde der Respekt für jedes Detail übernommen, um so in der Perfektion der Struktur die eigene Identität wiederzufinden. Dadurch erreicht Diverge eine entschlossene und reife Sprache, um in verschiedenen Umgebungen eingesetzt zu werden - vom Restaurant bis zur Wohnung - und unsere Entwicklung von Holzsesseln deutlich zu definieren.

ES Diverge es nuestra propuesta de silla de compás, de estilo sobrio y limpio. Retoma el respeto de los detalles típico de la arquitectura, hallando su identidad en la perfección de la estructura. Diverge expresa un lenguaje elegante y maduro que posibilita su aplicación en los contextos más variados, del restaurante a la vivienda, definiendo de forma clara nuestro estudio de la silla de madera.





TUBE

design
year

Giopato&Coombes
2012

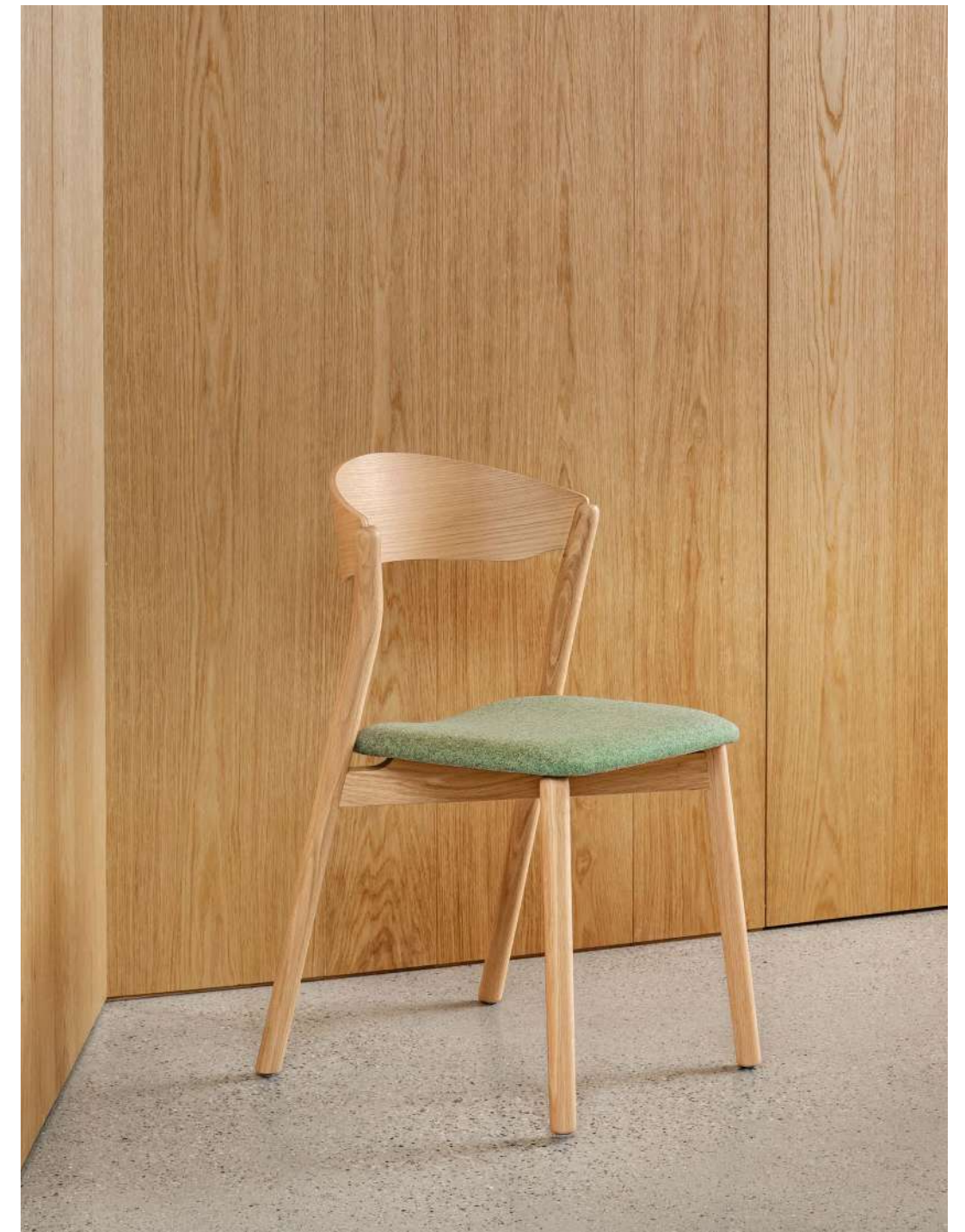



Tube viene letta come soluzione elegante per ristoranti e bistrot, con un'estetica che porta nel presente la tradizione della sedia in legno italiana.

EN Tube is designed as an elegant solution for restaurants and bistros, with an aesthetic which brings the tradition of an Italian wooden chair into the present.

FR Tube se présente comme une solution élégante pour les restaurants et les bistros, avec une esthétique qui fait revivre la tradition de la chaise en bois italienne dans le présent.

DE Tube wird als elegante Lösung für Restaurants und Bistros angesehen, der über eine Ästhetik verfügt, die die Tradition des italienischen Holzsessels in die Gegenwart bringt.

ES Tube se interpreta como una solución elegante para restaurantes y bistrot, con una estética que actualiza la tradición de la silla de madera italiana.



Valerie with armrests
Chair

Valerie
Chair

VALERIE

design
year

Giopato&Coombes
2011





Valerie with armrests
Chair

Soda
Coffee Table

Seduta realizzata completamente in legno curvato. Vuole essere l'espressione dell'archetipo della seduta, sia per il materiale utilizzato che nella forma. Non vuole stupire, ma assolvere la sua funzione primaria: accogliere. La composizione si sviluppa nella contrapposizione tra la struttura essenziale e la seduta realizzata in legno curvato. Due linguaggi destinati ciascuno ad assolvere una funzione specifica, il supporto e il comfort.

EN The chair is made in bended wood. It represents the essence of the sitting archetype, due to the used materials and to the form. Doesn't want to impress, just to perform in the better way the primary function: to accommodate. The chair develops the contrast between the essential structure and the wooden seat: the first devoted to the support and the second, to the comfort.

FR Assise réalisée complètement en bois courbé. Elle veut être l'expression de l'archétype du siège, tant par le matériau utilisé que dans la forme. Elle ne veut pas étonner, mais acquiescer sa fonction primaire: accueillir. La composition se développe dans l'opposition entre la structure essentielle et le siège réalisées en bois courbé. Deux langages destinés chacun à une fonction spécifique: le support et le confort.

DE Vollständig aus Bugholz bestehender Sessel. Sowohl aufgrund seiner Formgebung wie auch durch sein Material will er der Archetyp des Sessels sein. Es ist nicht sein Zweck, Erstaunen auszulösen, sondern nur der, seine primäre Funktion zu erfüllen: sich Setzende aufzunehmen. Sein Design erlangt er durch den Gegensatz zwischen der tragenden Struktur und der aus Bugholz gefertigten Sitzfläche. Zwei Ausdrucksformen, von denen jede ihre spezielle Funktion hat: das Tragen und die Bequemlichkeit.

ES Asiento realizado completamente en madera curvada. Quiere ser la expresión del arquetipo del asiento, tanto por el material utilizado como por su forma. No quiere asombrar, sino absolver su función primaria: acogida. La composición se desarrolla en la contraposición entre la estructura esencial y el asiento en madera curvada. Dos lenguas distintas cada una para una función específica: el soporte y el confort.



design
year

e-ggs
2018

IOLA

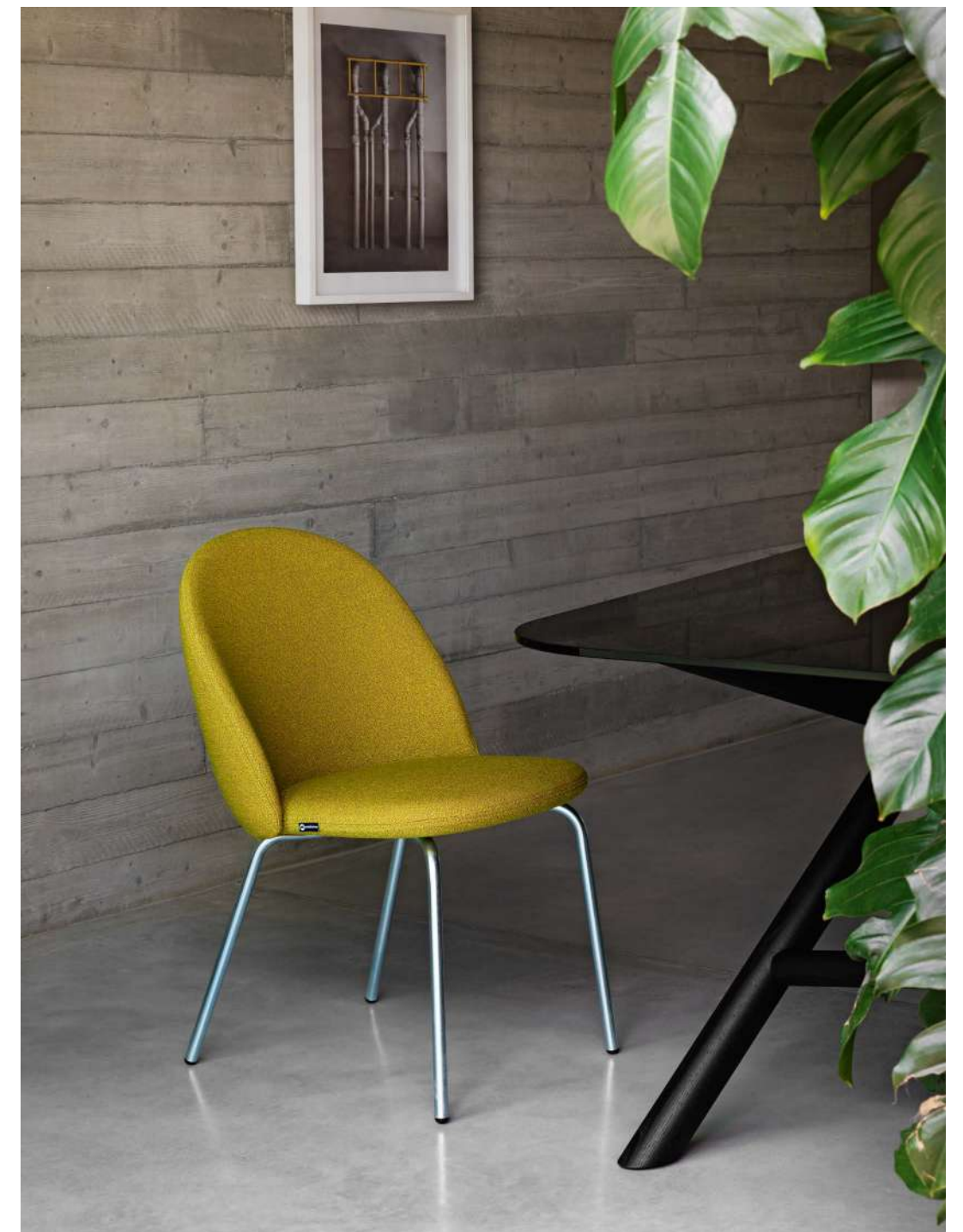



lola with armrests
Chair

lola vive il Design con un approccio internazionale, concentrandosi sull'ergonomia delle forme, mantenendo un aspetto curato e caratterizzante. Abbiamo dato alla scocca la forma di un guscio, producendola in poliuretano espanso. Sotto consiglio dei più esigenti, poi, le abbiamo tirato le orecchie così sono usciti due grandi braccioli. lola sa di moda, ma si propone come un classico contemporaneo.

EN lola shows off design with an international approach, focusing on the ergonomics of the form, ensuring a careful look, one with character. We have given the body the shape of a shell, producing it in expanded polyurethane. Then, on the advice of the hardest to please, we pulled the wings and then the two large arms came out. lola hints at fashion but comes across as a modern classic.

FR Le design de lola adopte une approche internationale, en se concentrant sur l'ergonomie des formes et en maintenant un aspect soigné et caractéristique. Nous avons donné à la coque la forme d'une coquille, en la produisant en mousse de polyuréthane. Sous le conseil des plus exigeants, nous lui avons ensuite « tiré les oreilles », afin d'obtenir deux grands accoudoirs. lola est un classique contemporain mais avec une touche mode.

DE lola lebt das Design mit einem internationalen Ansatz und konzentriert sich dabei auf die Ergonomie der Formen, ein sorgfältiges und typisches Aussehen wird dabei aufrecht erhalten. Wir haben der Sitzschale die Form einer Schale verliehen, aus Polyurethanschaum. Auf Anraten der Anspruchsvollsten haben wir dem Sessel dann die Ohren langgezogen, wodurch zwei große Armlehnen entstanden. lola hat einen modischen Akzent, ist jedoch als moderner Klassiker anzusehen.

ES lola experimenta el diseño con un enfoque internacional, centrándose en la ergonomía de las formas, manteniendo a la vez un aspecto cuidado y característico. Hemos plasmado el bastidor en forma de caparazón, fabricándolo en poliuretano expandido. Además, siguiendo los consejos de los más exigentes, le hemos tirado de las orejas y así surgieron dos reposabrazos grandes. lola sabe a moda pero se presenta como un clásico moderno.



Iola
Stool



Iola Office
Chair



Mula
Chair

Ozz Wall
Lamp

MULA

design
year

e-ggs
2018





Mula si fa riconoscere per l'ampio schienale dove due curiose orecchie si stringono sui fianchi, svelando un profilo dinamico della sedia. L'imbottitura della scocca diventa parte stessa del disegno, offrendo un prodotto realizzato con la massima cura, pensato per durare e piacere nel tempo.

EN Mula is recognised by its large backrest where two interesting wings hug the sides, revealing the chair's dynamic profile. The body's padding becomes part of the design, offering a product made with the utmost care, designed to last and to please over time.

FR Mula se distingue de par son large dossier formant deux curieuses «oreilles» enveloppantes, qui donnent un profil dynamique à la chaise. Le rembourrage de la coque fait partie intégrante du dessin de la chaise, en offrant un produit réalisé avec un grand soin et conçu pour durer et continuer à plaire dans le temps.

DE Mula ist dank der großen Rückenlehne erkennbar, an der sich zwei eigenartige Ohren seitlich festhalten und dem Stuhl so ein dynamisches Profil verleihen. Die Wattierung der Sitzschale aus Polyurethanschaum wird zum Teil des Designs, wodurch ein mit besonderer Sorgfalt hergestelltes Produkt hergestellt wird, das über den Lauf der Zeit halten und Freude bereiten soll.

ES Mula se caracteriza por el amplio respaldo en el que dos divertidas orejas se ajustan a los costados, revelando un perfil dinámico de la silla. El mullido del bastidor se convierte en parte integrante del diseño, ofreciendo un producto realizado con cuidado máximo, concebido para durar y apreciar en el tiempo.



MARIOLINA

design
year

e-ggs
2018

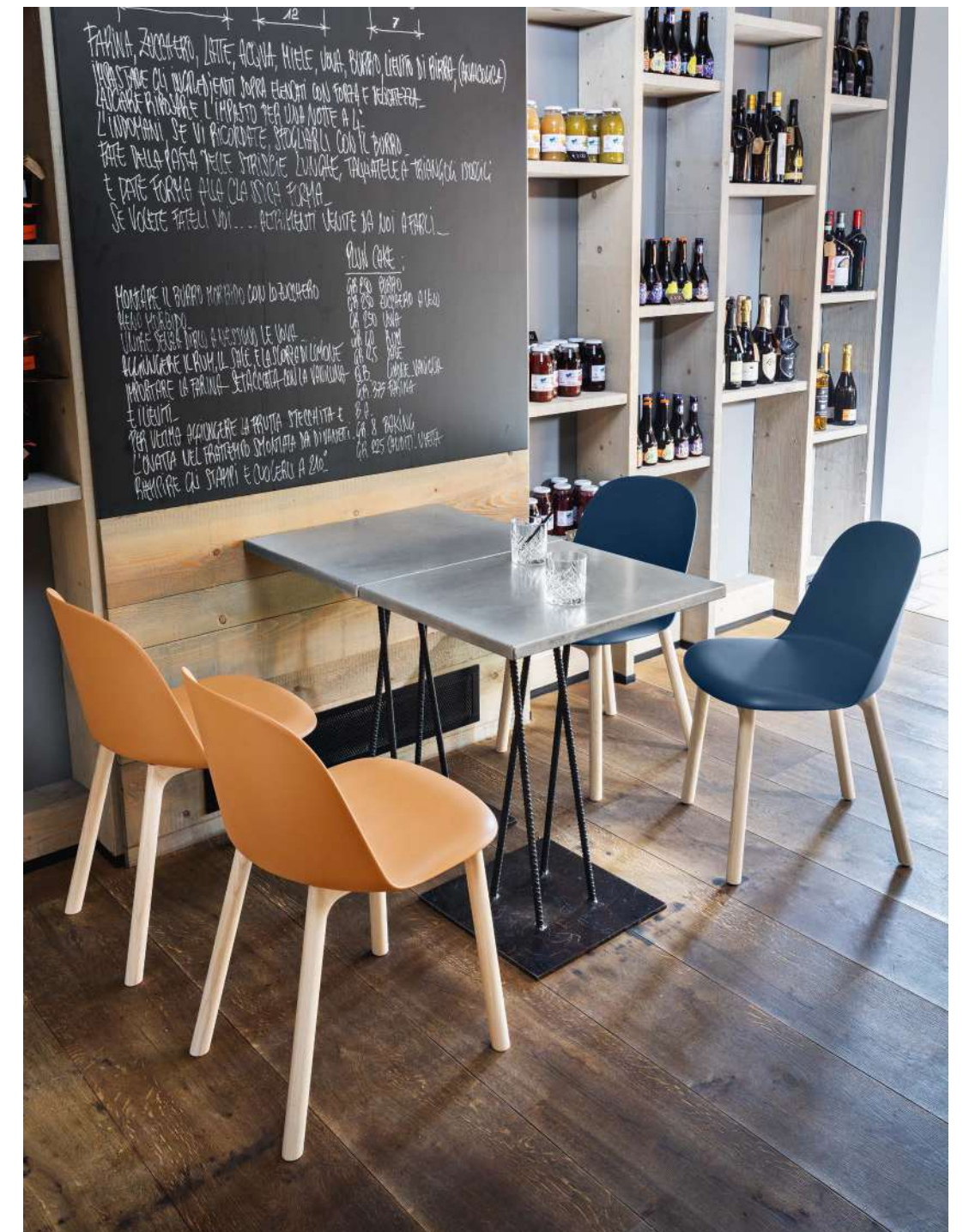



Mariolina Edu
Chair



Mariolina Office
Chair



Mariolina
Stool

Mariolina è nata esplorando il mondo del polipropilene e i suoi nuovi sviluppi, abbinandosi delicatamente ad una estetica essenziale. La scocca è così semplice che puoi disegnarla senza staccare la penna dal foglio, bilanciando uno stile curato e attento al presente con la volontà di uscire dalle mode. Mariolina è la risposta alla necessità di un prodotto eclettico, realizzato con un metodo produttivo contemporaneo e adatto alla vita di tutti i giorni.

EN Mariolina came from an exploration into the world of polypropylene and its new developments, combining it with a delicate, honest aesthetic. The body is so simple that it can be drawn without the pen leaving the paper, balancing a careful style, attentive to the present, with the desire to break free of fashion. Mariolina is the answer to the need for an eclectic product, made with a contemporary production method and suitable for everyday life.

FR Mariolina est née de l'exploration du monde du polypropylène et de ses nouvelles possibilités, en les unissant à une esthétique délicate et franche. La coque, tellement simple qu'il est possible de la dessiner d'un seul trait, concilie un style soigné et attentif au présent, avec la volonté de sortir de la mode. Mariolina répond à la nécessité d'un produit de style éclectique, réalisé avec une méthode de production contemporaine et qui soit adapté à la vie de tous les jours.

DE Mariolina entstand, als wir die Welt des Polypropylen und seine neuen Entwicklungen entdeckten und mit einer zarten und ehrlichen Ästhetik vereinten. Die Sitzschale ist so einfach, dass sie entworfen werden kann ohne den Stift vom Blatt abzusetzen. Dabei wurde ein sorgfältiger und moderner Stil mit dem Willen kombiniert, den Trends nicht zu folgen. Mariolina ist die Antwort auf die Forderung nach einem eklektischen Produkt, das mit einer modernen Produktionstechnik entwickelt wird und für den Alltag geeignet ist.

ES Mariolina es el resultado de la exploración del sector del polipropileno y sus nuevas aplicaciones, en combinación con una estética delicada y apreciada. El bastidor es tan sencillo que se puede dibujar sin levantar el bolígrafo del papel, combinando de forma equilibrada un estilo cuidado y mirando al presente con la voluntad de ir más allá de las modas. Mariolina es la respuesta a la necesidad de un producto ecléctico, realizado adoptando un método productivo moderno y adecuado para la vida cotidiana.



Mariolina Edu
Chair





Mariolina
Chair



Mariolina
Chair and dolly



Leda with armrests
Chair

LEDA

design
year

Francesco Beghetto
e Antonio Manaigo
2012





Leda è nata per dare una forma istituzionale al comfort. L'abbiamo pensata con una silhouette morbida e pulita, per proporre una seduta che sappia dare il giusto valore a spazi privati e pubblici, dall'home office alla sala conferenze.

EN Leda was created to give an institutional form to comfort. We designed it to have a soft, clean silhouette, to offer a chair that knows how to bring the right value to private and public spaces alike, from the home office to the conference room.

FR Leda est née pour donner une forme institutionnelle au confort. Nous l'avons conçue avec une silhouette délicate aux lignes nettes, afin de proposer une chaise en mesure de mettre en valeur des espaces privés et publics allant du bureau de la maison à la salle de conférence.

DE Leda entstand, um dem Komfort eine institutionelle Form zu verleihen. Wir haben sie mit einer weichen und klaren Silhouette versehen, um eine Sitzfläche anzubieten, die privaten und öffentlichen Räumen den richtigen Wert verleiht - vom Homeoffice bis zum Konferenzraum.

ES Leda ha sido creada para dar una forma institucional al confort. Ha sido concebida con una silueta suave y limpia, para presentar una asiento capaz de valorizar de modo adecuado espacios privados y públicos, ya sea una oficina en casa o una sala de conferencias.



design
year

Zaven
2014

DUMBO





Dumbo è la sedia imbottita universale: abbondante ma leggera, è caratterizzata da due orecchie che dilatano lo schienale, rendendolo ancora più grande e accogliente.

EN Dumbo is the universal padded chair, generous yet lightweight. Its backrest appears to have two ears extending from it, making it even bigger and cosier.

FR Dumbo est la chaise rembourrée universelle: légère malgré ses formes généreuses, elle est caractérisée par deux oreilles qui dilatent le dossier, en le rendant encore plus grand et accueillant.

DE Dumbo ist ein gepolsterter Sessel für jeden Bedarf: üppig aber leicht, zwei charakteristische Ohren erweitern die Rückenlehne und machen sie noch größer und einladender.

ES Dumbo es la silla tapizada universal: abundante pero ligera, se caracteriza por dos orejas que dilatan el respaldo, haciéndolo todavía más grande y acogedor.



PELÈ

Pelè è interamente imbottita, dallo schienale alle gambe. Ha un tocco borghese, forme arrotondate e riesce ad essere estremamente versatile in qualsiasi ambiente.

EN Pelè is completely padded, from the backrest to the legs. With its bourgeois air and rounded shape, it is extremely versatile and fits in any environment.

FR Pelè est entièrement rembourrée, du dossier aux pieds. Elle a un caractère bourgeois, des formes arrondies et parvient à s'adapter à n'importe quel environnement.

DE Pelè ist vollständig gepolstert, von der Rückenlehne bis zu den Beinen. Von gut bürgerlicher Ausstrahlung, mit gerundeten Formen, kann sich ungemein flexibel jedem Ambiente anpassen.

ES Pelè es totalmente acolchada, desde el respaldo hasta las patas. Transmite una imagen burguesa con formas redondeadas y demuestra su extrema versatilidad en cualquier ambiente.



Marino
Seat

Pelleossa
Chair

MARINO

design
year

e-ggs
2020

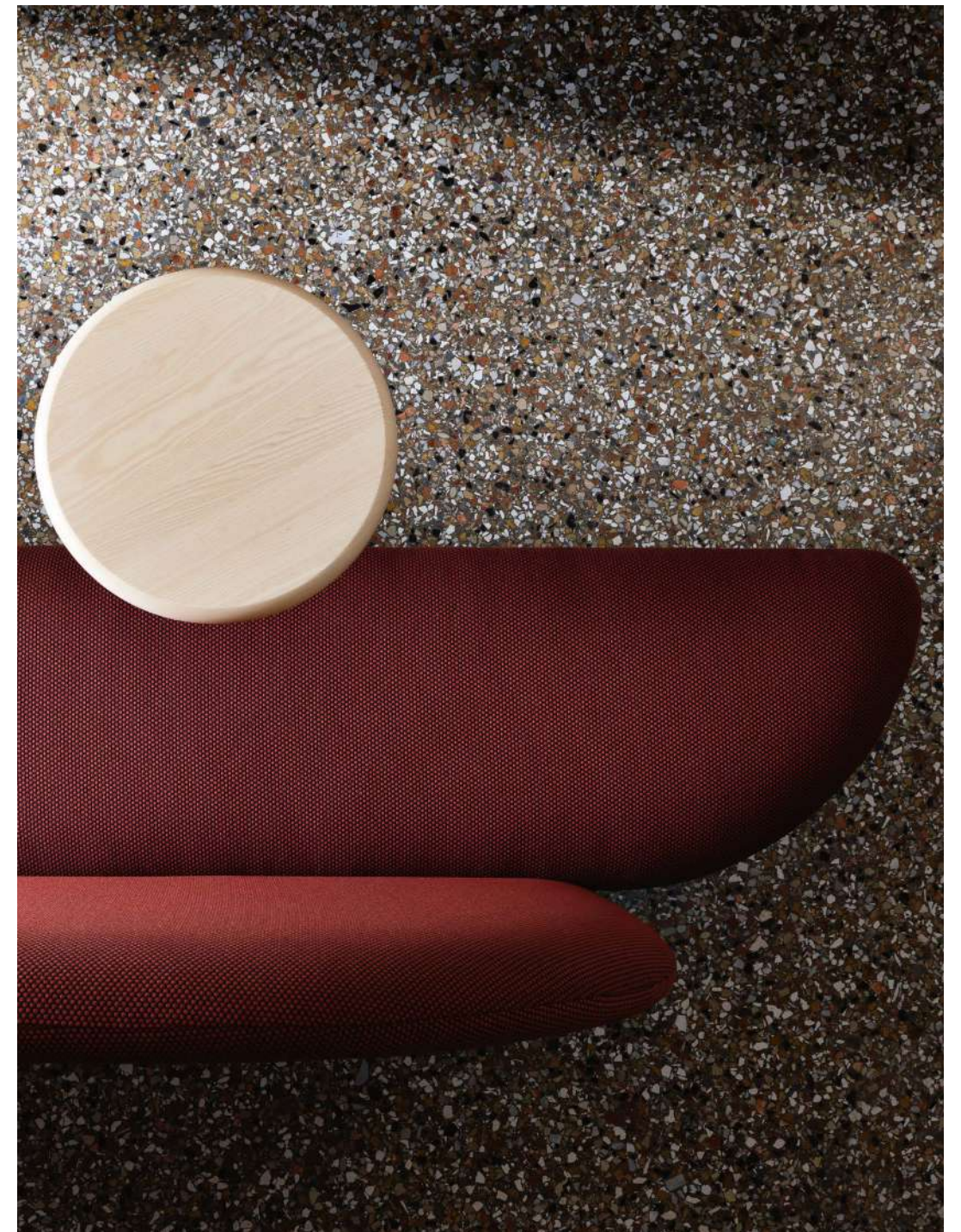



Marino è un sistema di panche modulari per configurare gli spazi in libertà. Dalle forme organiche, sedute e schienali si combinano e si trasformano, rafforzati da una intera gamma di accessori che lo rendono pratico sia per separare gli ambienti che per organizzare un bistrot o un ingresso domestico. Il programma di Marino offre soluzioni multiple, agili e accoglienti che sanno sempre distinguersi.

EN Marino is a system of modular benches with which to freely arrange your space. The organically-shaped seating and backs combine and transform, enhanced by a complete range of accessories that make it handy both for dividing spaces and for organizing a bistrot or a domestic hallway. The Marino programme offers multiple agile and welcoming solutions that will always catch the eye.

FR Marino est un système de banquettes modulaires pour configurer librement les espaces. Avec leurs formes organiques, les assises et les dossiers se combinent et se transforment, renforcés par toute une gamme d'accessoires qui les rendent encore plus pratiques tant pour séparer les espaces que pour organiser un bistrot ou une entrée. Le programme de Marino offre des solutions multiples, souples et accueillantes qui savent créer la différence.

DE Marino ist ein System von modularen Sitzbänken, die den Raum in aller Freiheit gestalten. Die Sitzflächen und Rückenlehnen in organischen Formen verbinden und verwandeln sich, unterstützt durch ein komplettes Sortiment zweckmäßiger Accessoires, um Räume zu trennen oder ein Café oder eine Diele zu organisieren. Das Programm von Marino bietet vielfältige, dynamische, gemütliche und überzeugende Lösungen, die immer auch originell sind.

ES Marino es un sistema de bancos modulares para configurar espacios en libertad. Los asientos y los respaldos, de formas orgánicas, se combinan y se transforman, reforzados por toda una gama de accesorios que permiten tanto separar ambientes como organizar un café o la entrada de una casa. La serie Marino ofrece soluciones múltiples, ágiles y acogedoras, siempre con un toque de distinción.

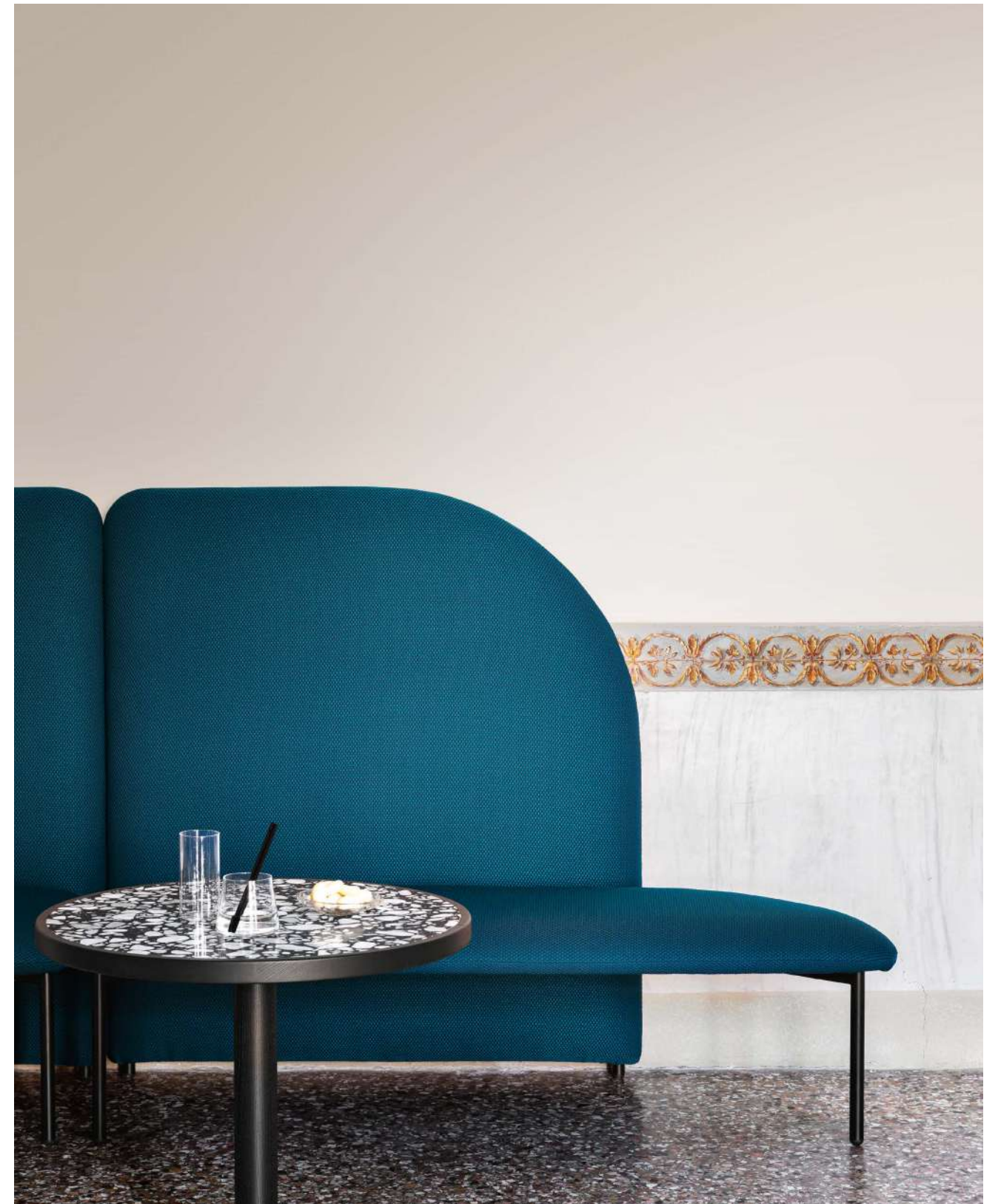

Marino
Seat

Briscola
Coffee Table



They are traditionally considered as a support on which to see over things, or just for a quick sit and wait. But with these colors and eccentric appeal, our stools declare a new role in both private and contract spaces.



VITOS

design
year

Paolo Cappello
2011





Vitos utilizza il colore per rinfrescare lo spazio e il legno per pulirne gli eccessi. La forma è scherzosa e iconica, distinguendosi facilmente nel mercato. Disponibile piccolo, medio e alto.

EN Vitos uses colour to refresh spaces and wood to clear away the excess. The form is playful and iconic, easily standing out in the market. Available in low, medium and tall size.

FR Vitos utilise la couleur pour rafraichir l'espace et le bois pour mitiger ses excès. Sa forme iconique est un clin d'oeil lui permettant de se distinguer facilement sur le marché. Disponible en version basse, moyenne et haute.

DE Vitos verwendet Farbe, um den Raum aufzufrischen, und Holz, um Überschüssiges zu entfernen. Die Form ist schmerzhaft und ikonisch, wodurch sie am Markt leicht zu erkennen ist. Klein, mittelgroß und groß verfügbar.

ES Vitos emplea el color para renovar el ambiente y la madera para pulir los excesos. Su forma es alegre e icónica, distinguiéndose fácilmente en el mercado. Disponible en formato pequeño, mediano y alto.



FERROVITOS

Ispirato dagli sgabelli utilizzati in passato nelle scuole italiane, è un oggetto essenziale, che sa riconoscere quando apparire sobrio e quando scatenarsi, macchiando con il colore la struttura.

EN Drawing its inspiration from the stools used in the past in Italian schools, this essential item knows when to appear discreet and when to dare a brightly coloured frame.

FR S'inspirant des tabourets utilisés autrefois dans les écoles italiennes, c'est un objet essentiel, qui sait s'adapter en choisissant la sobriété ou au contraire, en misant sur la fantaisie avec les différentes couleurs de la structure.

DE Die Anregung kommt von den Hockern, die früher in italienischen Schulen verwendet wurden: ein essentielles Möbel, das weiß, was sich gehört, es kann gesittet sein oder ausgelassen das Gestell mit Farbe befecken.

ES Inspirado en las banquetas que se usaban en pasado en las escuelas italianas, es un objeto esencial, que sabe reconocer cuándo parecer sobrio y cuando desencadenarse, manchando la estructura de color.

design
year

Paolo Cappello
2015



MILK

design
year

Paolo Cappello
2012

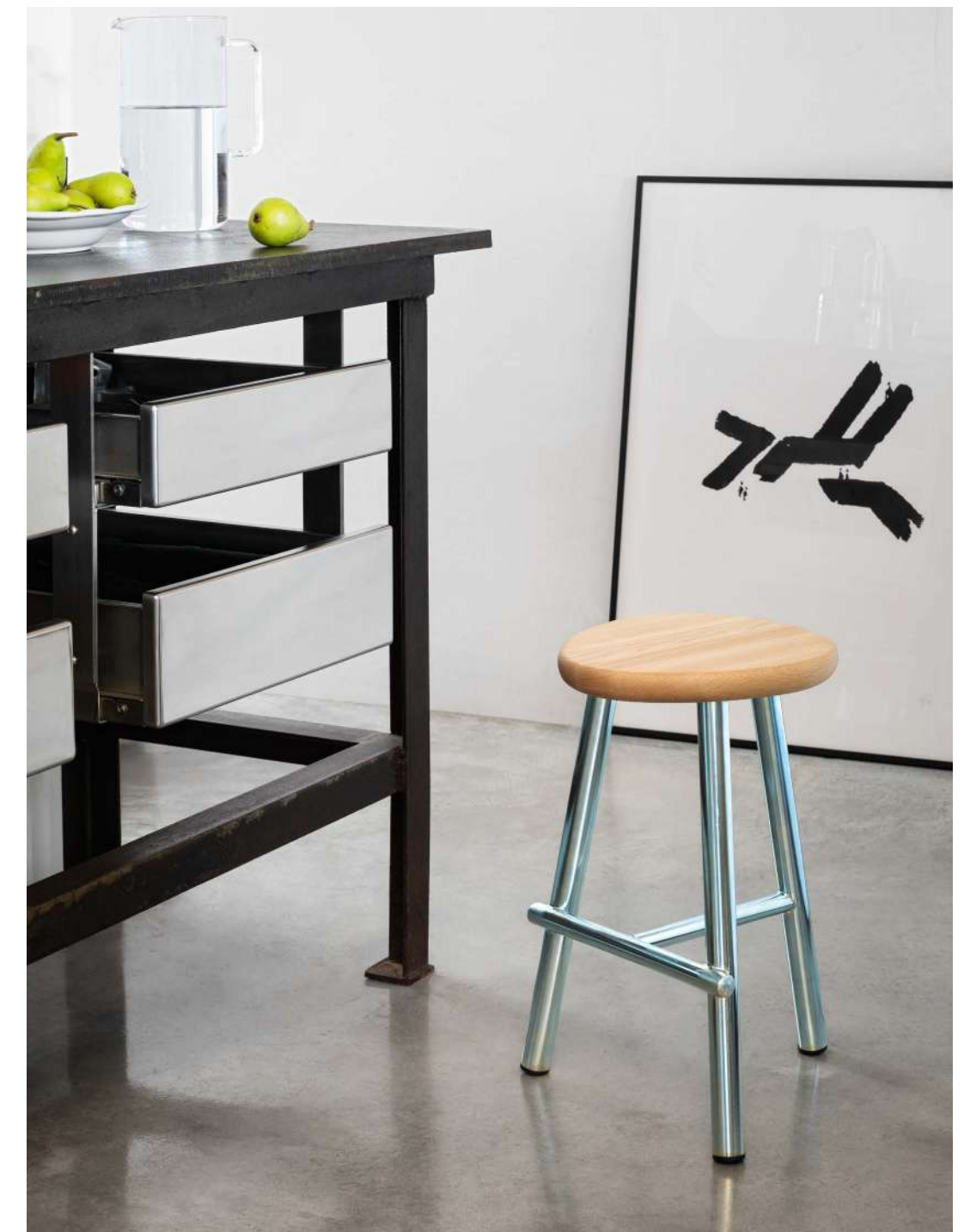



Il concept di Milk si scopre nelle sedute usate in passato per la mungitura. È un omaggio alla tradizione rurale, dove tutto è prodotto orgogliosamente in casa, tra mattoni a vista e tanto verde.

EN The concept for Milk is found in the chairs used in the past for milking. It is a homage to rural tradition, where everything is proudly made at home, between exposed brick and acres of greenery.

FR Le concept de Milk s'inspire des tabourets utilisés autrefois pour la traite. C'est un hommage à la tradition rurale, qui rappelle les murs en pierres apparentes et la nature, dans un contexte où tout était fièrement produit sur place.

DE Das Konzept von Milk ist in den Sitzmöbeln wiederzufinden, die in der Vergangenheit zum Melken eingesetzt wurden. Eine Hommage an die ländliche Tradition, wo alles mit Stolz selbst gemacht wird: zwischen sichtbaren Ziegelwänden und viel Grün.

ES El concept de Milk se revela en los asientos utilizados en el pasado para el ordeño. Rinde un homenaje a la tradición rural, en la que todo se produce con orgullo en casa, entre ladrillos cara vista y mucha vegetación.



PEZZO

Pezzo è un esercizio di geometria sull'equilibrio dei solidi, in questo caso realizzati in massello di rovere o noce.

EN Pezzo is an exercise in geometry on the balance of solids. In this case, made in solid oak or walnut.

FR Pezzo est le fruit d'un exercice de géométrie sur l'équilibre des solides qui, dans ce cas, sont réalisés en bois massif d'êtré ou de noyer.

DE Pezzo ist eine geometrische Übung mit dem Gleichgewicht von Feststoffen, die in diesem Fall aus massivem Eichen- und Nussholz bestehen.

ES Pezzo es un ejercicio de geometría sobre el equilibrio de sólidos, en este caso realizados en madera maciza de roble o nogal.

design
year

Stephanie Jasny
2013





Even laziness has to be made seriously: that's the why we created a world of fluffly and well-stuffed decor, so that you can take (seriously) care of your self.



design
year

Skrivo
2013

COLONY

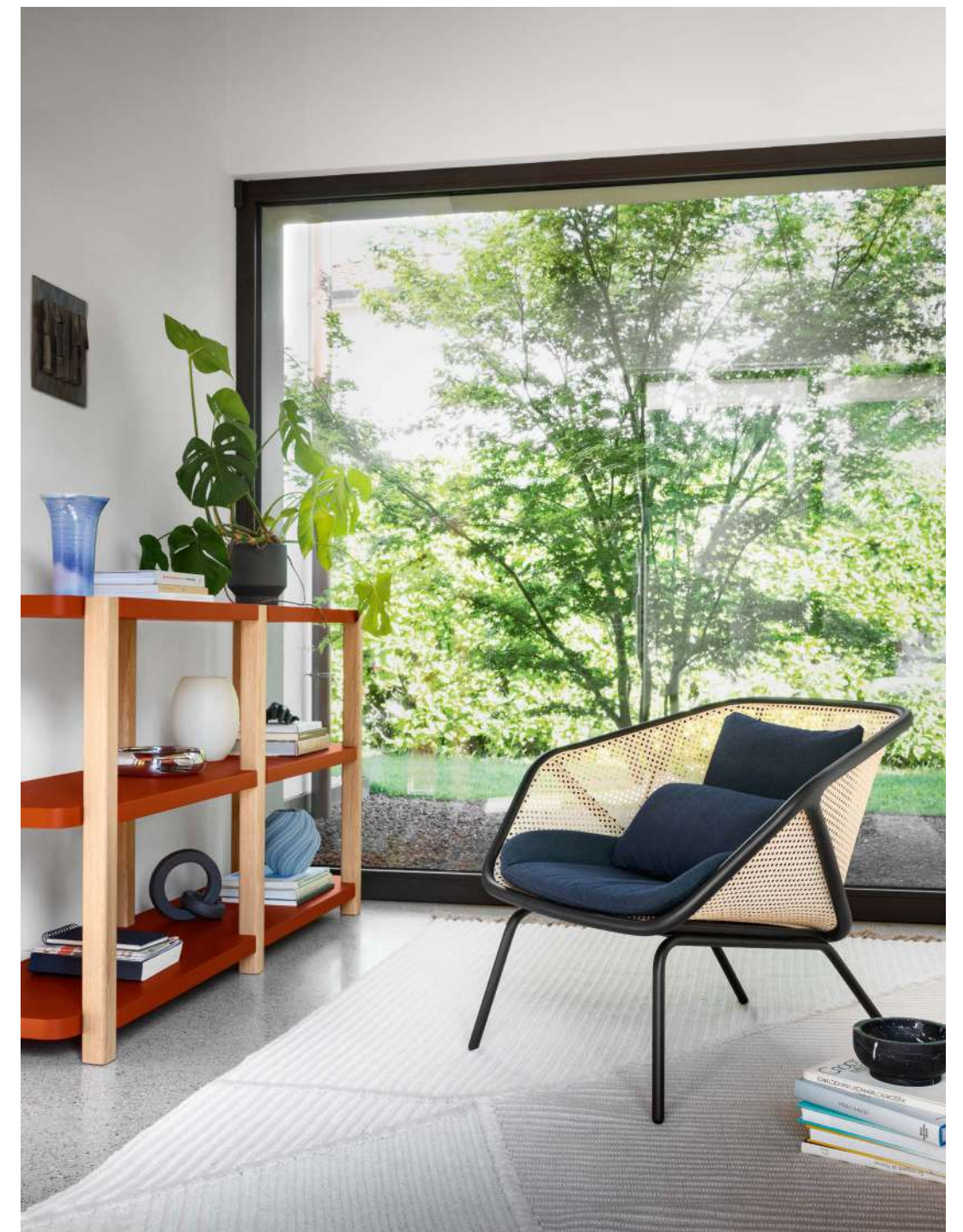



Colony
Armchair

Soda
Coffee table

Ozz
Lamp

Furoshiki
Pouf

Colony è sempre la stessa, ma ora può prendere il sole. La struttura è in legno di Iroko, particolarmente adatto all'outdoor, mentre la paglia di vienna viene trattata in modo da resistere con moderazione ai cambiamenti improvvisi del clima.

EN Colony remains the same, but now it can soak up the sun. The frame is made of iroko timber, which is particularly suited to outdoor use, while the Viennese straw is treated to enable it to withstand to some degree abrupt changes in weather conditions.

FR Colony est toujours le même, mais maintenant, il peut prendre le soleil. La structure est en bois d'Iroko, particulièrement adapté à l'extérieur, tandis que le cannage est traité pour résister jusqu'à un certain point aux brusques changements de climat.

DE Es ist immer Colony, jetzt darf es aber auch in die Sonne. Das Gestell ist aus Iroko, ein besonders für die Aufstellung im Freien geeignetes Holz, während das Wiener Geflecht behandelt wird, um mit Moderation plötzlichen Wetterumschlägen widerstehen zu können.

ES Colony sigue siempre igual, pero ahora puede tomar sol. La estructura es de madera de iroko, especialmente apta para el uso en exteriores, mientras que el tratamiento de la paja de Viena contribuye a resistir con moderación a los cambios climáticos repentinos.



Colony
Armchair

Colony Screen
Accessories



SERCIA

design
year

Francesco Beghetto
2016





Sergia
Armchair

Mastea
Coffee table

Sergia è affascinante nella sua semplicità, non cerca risultati sconvolgenti, ma esprime il desiderio nostalgico del ventesimo secolo per gli anni '50. Tutto in un'ottica che enfatizza la comodità e l'ergonomia.

EN Sergio is fascinating in its simplicity; it does not look for shocking results, but expresses the nostalgic longing of the twenty-first century for the Fifties. Everything about it speaks of comfort and ergonomics.

FR Sergio fascine par sa simplicité ; elle ne cherche pas des résultats bouleversants, mais exprime le désir nostalgique du vingt-et-unième siècle pour les années 1950. Le tout en soulignant le confort et l'ergonomie.

DE Sergio fasziniert durch seine Einfachheit und sucht nicht nach überwältigenden Ergebnissen, sondern bringt den nostalgischen Wunsch des 21. Jahrhunderts nach der 50er-Jahre zum Ausdruck. Das alles geschieht aus einem Gesichtspunkt, der Komfort und Ergonomie stark betont.

ES Sergio con su cautivadora sencillez no persigue resultados sorprendentes, sino que expresa el deseo nostálgico del siglo veintiuno por los años cincuenta. Todo ello según una óptica que enfatiza el confort y la ergonomía.



Boterina
Armchair

Soda
Coffee table

Cigales
Accessories

BOTERINA

design
year

e-ggs
2020

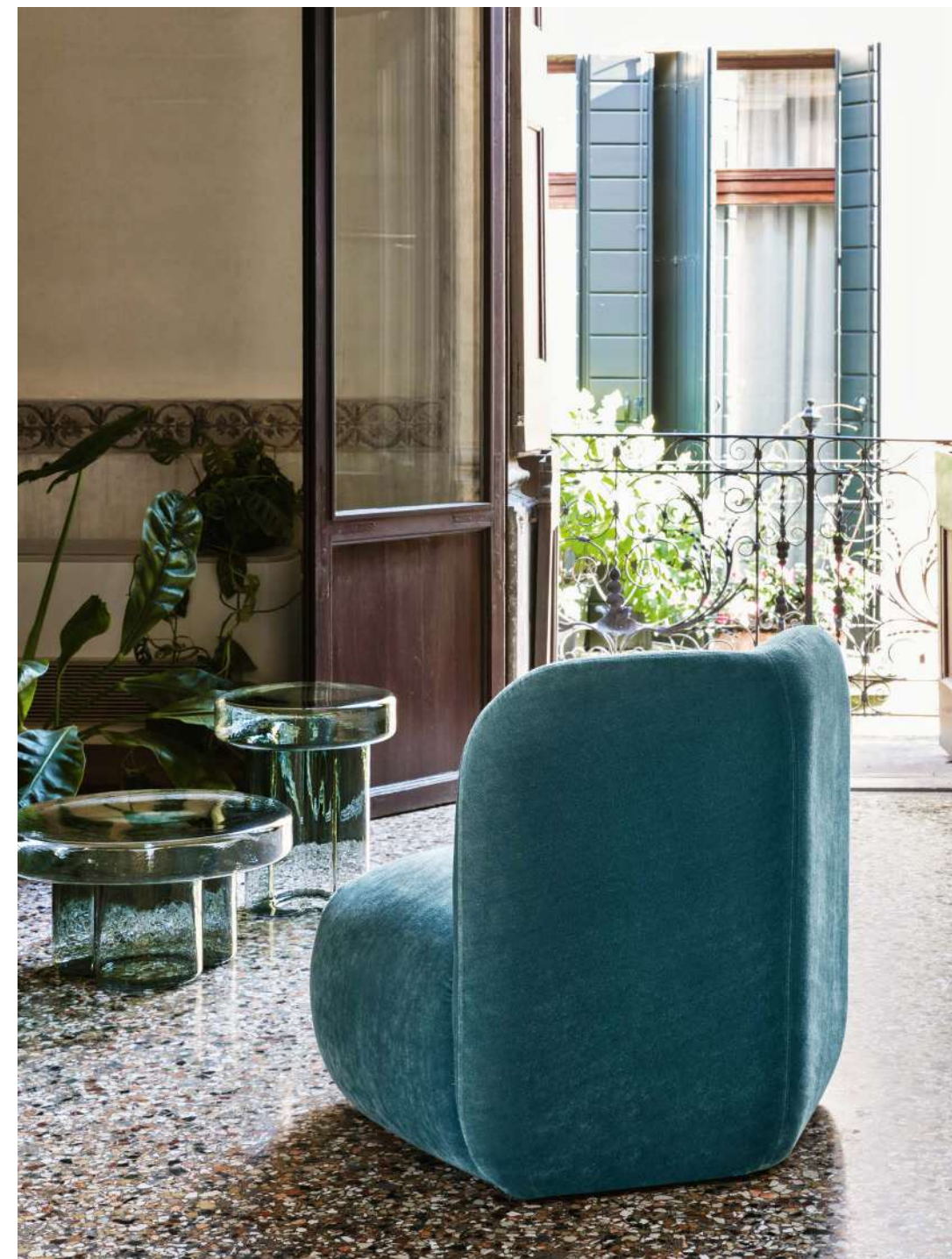



Boterina
Armchair

Soda
Coffee table

I moduli sono eclettici, pensati per uno spazio che cambia. Dall'esuberanza del divano alla scioltezza dei pouf, i moduli si distendono nell'ambiente in lunghe composizioni o accomodanti nicchie. Boterina, infine, è la più piccola della famiglia, una poltroncina che con i suoi volumi ridotti si mostra agile anche negli ambienti meno ampi.

EN These eclectic modules are conceived for spaces that change. From the exuberance of the sofa to the casual ease of the pouf, these modules expand into their space in long compositions or contract to fill cosy nooks. Finally, Boterina, the smallest member of the family, is a more compact chair that will prove agile even in less spacious settings.

FR Les modules sont éclectiques, conçus pour un espace qui change. De l'exubérance du canapé à la fluidité des poufs, les modules se déploient dans l'espace dans de longues compositions ou en niches accueillantes. Boterina, enfin, est le plus petit de la famille, un fauteuil qui avec ses volumes réduits est agile même dans les plus petites pièces.

DE Die Module sind anpassungsfähig, für Räume, die sich ändern. Ob üppiges Sofa oder lässiger Fußhocker, die Module breiten sich im Raum aus und bilden lange Sitzlandschaften oder gemütliche Ecken. Boterina ist das kleinste Mitglied der Familie und fügt sich gewandt auch in kleinere Räume ein.

ES Se trata de módulos eclécticos, pensados para un espacio cambiante. De la exuberancia del sofá a la ligereza del puf, los módulos se despliegan en el entorno en forma de largas composiciones o cómodos cobijos. Por último, Boterina, la más pequeña de la familia, es una butaca que con su reducido volumen se muestra ágil incluso en los espacios más limitados.



Botera
Armchair

Kolos
Coffee Table

design
year

e-ggs
2019

BOTERA





Imbottita con quattro tipologie di gomme diverse, lo studio di Botera si concentra sulla comodità. Da un cuscino paffuto si espande lo schienale, alto o basso, che porta la poltrona a dialogare con un linguaggio modulare. È proprio nelle composizioni, infatti, che Botera diventa un elemento di condivisione dal quale si sviluppa la vita sociale, abbattendo gli ultimi limiti tra domestico e contract a favore di uno spazio ibrido, morbido e personale. A Botera piace stare in compagnia, soprattutto nei luoghi pubblici, ma a casa se la passa bene anche da sola.

EN Padded with four different types of foam, Botera's design focuses on comfort. A chunky cushion forms the base from which the high or low backrest is developed, making this armchair ideal for use in modular arrangements. And it is precisely through its compositions that Botera brings people together and encourages them to socialise, breaking down the final boundaries between home and contract settings to create a soft, personal, hybrid space. Botera loves being in company, especially in public spaces, but at home it also enjoys being on its own.

FR Avec son rembourrage en quatre types de mousses différentes, le projet de Botera se concentre sur la commodité. Le dossier, haut ou bas, se développe à partir d'un coussin rebondi qui conduit le fauteuil à dialoguer avec un langage modulaire. C'est dans les compositions, en effet, que Botera devient un élément convivial où se développe la vie sociale, en abattant les dernières frontières entre la maison et les collectivités en faveur d'un espace hybride, confortable et personnel. Botera aime être en compagnie, surtout dans les lieux publics, mais à la maison il se trouve bien aussi tout seul.

DE Mit vier verschiedenen Gummiarten gepolstert: bei Botera ist Bequemlichkeit Trumpf. Aus dem rundlichen Kissen entwickelt sich die Rückenlehne, hoch oder niedrig, die dem Sessel modulare Möglichkeiten eröffnet. Und gerade in Zusammenstellungen wird Botera zu einem gemeinschaftlichen Element, das um sich ein geselliges Leben entstehen lässt und die letzten Schranken zwischen Wohnungs- und Objekteinrichtung aufhebt, zu Gunsten gemischter Räume, fließend und persönlich. Botera liebt Gesellschaft, vor allem in öffentlichen Räumen, aber fühlt sich auch allein zu Hause wohl.

ES Acolchado con cuatro tipos diferentes de gomas, el estudio de Botera se focaliza en la comodidad. A partir de un cojín regordete se extiende el respaldo, alto o bajo, que lleva al sillón a dialogar con un lenguaje modular. Es precisamente en las composiciones donde Botera, de hecho, se convierte en un elemento para compartir, del cual se desarrolla la vida social, rompiendo los últimos límites entre el hogar y el espacio colectivo, en favor de un entorno híbrido, delicado y personal. A Botera le gusta estar en compañía, especialmente en lugares públicos, pero en casa también le va bien por su cuenta.



Botera
Armchair and pouf

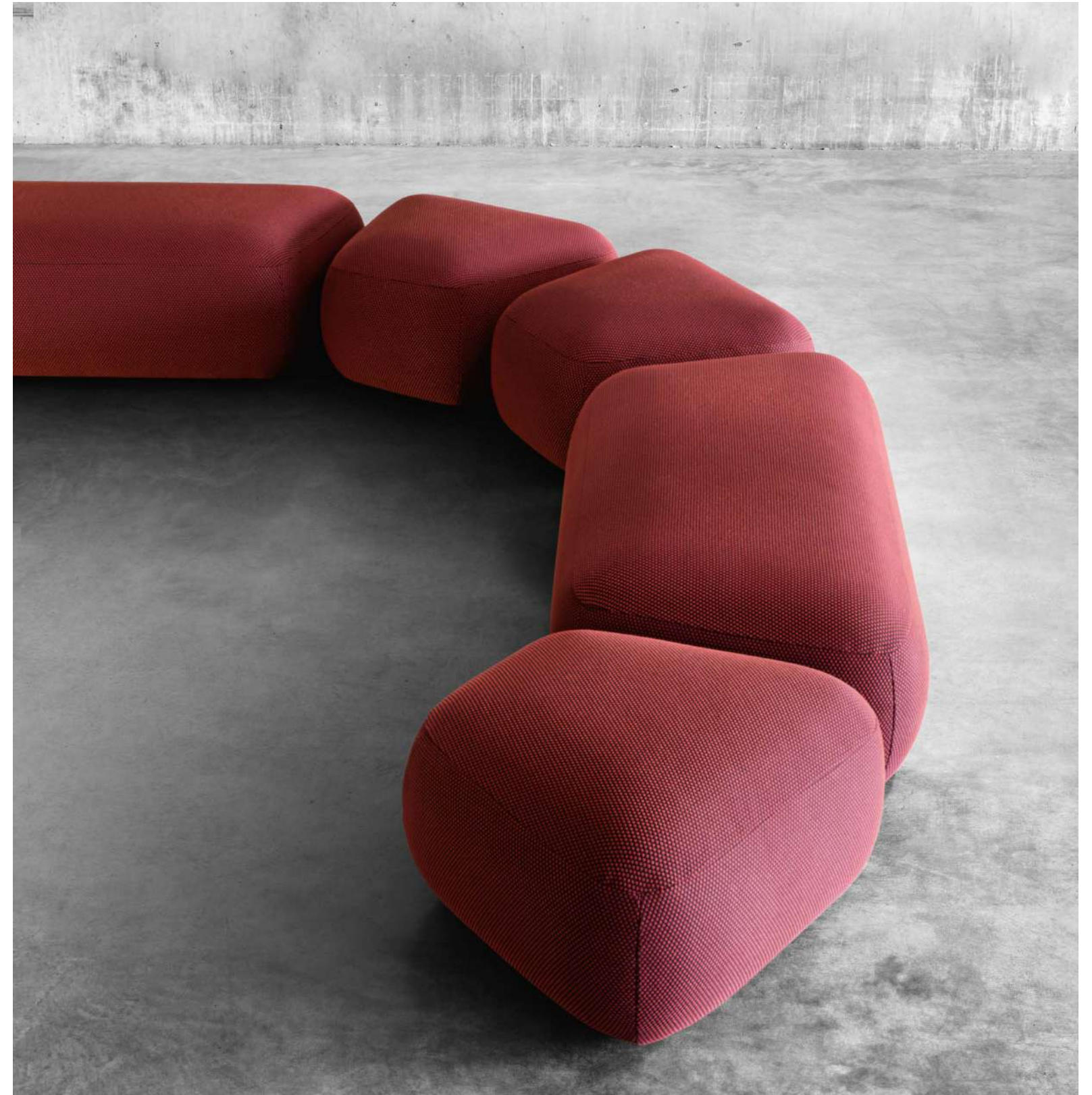

Botera
Pouf



Boterina
Armchair

Botera
Sofa and pouf

Soda
Coffee table

Ozz Floor
Lamp





Botera
Sofa and pouf

Illo
Coffee table





LEM ARMCHAIR

design
year

Francesco Beghetto
2014





Lem
Sofa

Milonga
Bookshelve

Ozz Floor
Lamp

Soda
Coffee table

LEM SOFA

design
year

Francesco Beghetto
2014

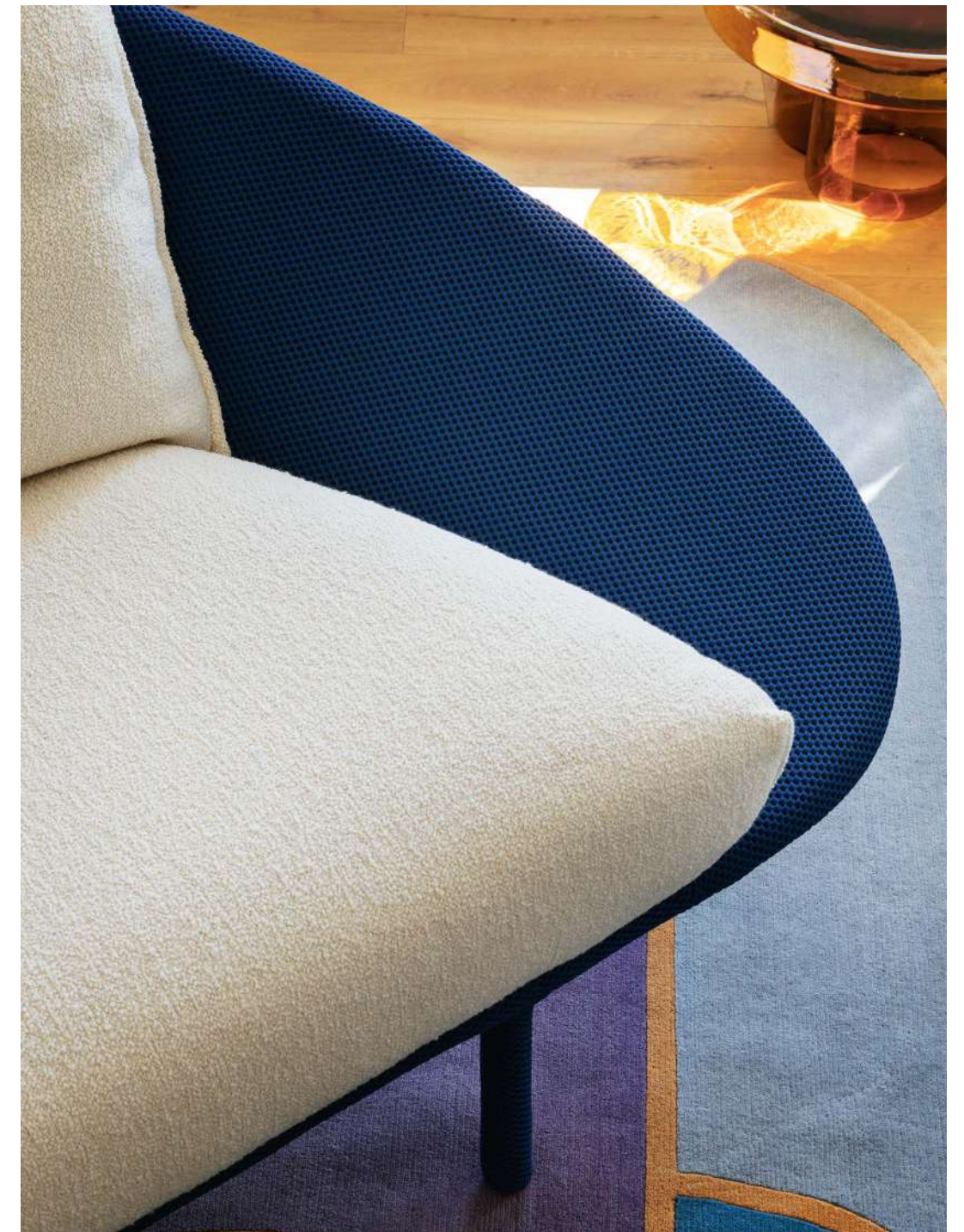



Lem è un divano morbido e sinuoso, con una struttura interamente rivestita, che si slancia verso l'alto con dolci piedini. I morbidi cuscini della seduta e dello schienale si appoggiano sul guscio di tessuto garantendo il massimo comfort. La serie Lem è completa di quattro varianti, divano due e tre posti, poltroncina e ottomana.

EN Lem is a soft and sinuous sofa with a completely upholstered structure that ascends with sweet, little feet. The soft cushions of the seat and the back lean on the fabric shell, ensuring maximum comfort. The Lem series includes four variants, two or three seater sofa, armchair, and ottoman.

FR Lem est un canapé moelleux et sinueux, avec une structure entièrement revêtue de tissu, qui s'élance en hauteur grâce à ses pieds. Les coussins moelleux de l'assise et du dossier s'appuient sur la coque de tissu en garantissant un confort maximum. La série Lem existe en quatre variantes, canapé deux et trois places, petit fauteuil et divan.

DE Lem ist ein weiches Sofa mit geschwungenen Formen. Das Gestell ist komplett mit Stoff überzogen und strebt ausgehend von liebevollen Füßen nach oben. Die weichen Polster der Sitzfläche und der Rückenlehne lehnen sich an den Stoff der Sitzschale an und sorgen so für maximalen Komfort. Die Serie Lem ist in vier Varianten verfügbar: zweisitzer oder dreisitzer Sofa, Armlehnstuhl und Ottomane.

ES Lem es un sofá blando y sinuoso, con una estructura totalmente tapizada en tejido, que se lanza hacia lo alto con sus patas delicadas. Los cojines suaves del asiento y del respaldo se apoyan sobre el caparazón de tejido garantizando máximo confort. La serie Lem consta de cuatro versiones, sofá de dos y tres plazas, sillón y otomana.



Louise
Sofa

Mistea
Coffee table

Cigales
Accessories

LOUISE

Bergère che reinterpreta i classici del design, è una poltrona lussureggiante e senza tempo che fa del comfort il suo principale punto di forza.

EN A bergère that reinterprets the design classics, the key strength of this lush, timeless armchair is its comfort.

FR Une bergère qui réinterprète les classiques du design, un fauteuil somptueux et intemporel qui fait du confort son principal atout.

DE Eine Bergère, die diesen Designklassiker neu interpretiert: ein üppiger, zeitloser Sessel, der im Komfort seine große Stärke hat.

ES Un sillón Bergère che reinterpreta los clásicos del diseño, lujoso y atemporal, convierte el confort en su principal punto fuerte.



DIPLOPIA

Diploia affronta il tema del "doppio" e dello "sdoppiamento". La ripetizione della seduta, dello schienale e delle gambe, accostate all'uso del poliuretano espanso, ne fanno una poltrona strutturalmente forte e visivamente disinvolta che non soffoca in nessun tipo di ambiente.

EN Diploia addresses the theme of the 'double' and the 'splitting'. The repetition of the seat, the back, and the legs, combined with the use of polyurethane foam, makes it a structurally strong and visually casual chair that does not suffocate in any type of environment.

FR Diploia aborde le thème du « double » et du « dédoublement ». Le dédoublement de l'assise, du dossier et des pieds associé à l'utilisation du polyuréthane expansé en fait un fauteuil à la structure forte et visuellement désinvolte qui n'étouffe dans aucun environnement.

DE Diploia verkörpert die Themen „doppelt“ und „Verdoppelung“. Das Wiederaufgreifen der Sitzfläche, der Rückenlehne und der Beine kombiniert mit Polyurethanschaum, verleiht diesem Armlehnstuhl eine sichtbar ungezwungene, starke Struktur, die von keinem Raum erdrückt werden kann.

ES Diploia aborda el tema del "doble" y del "desdoblamiento". La repetición del asiento, el respaldo y las patas, junto con el uso del poliuretano expandido, convierte el sillón en una pieza fuerte desde el punto de vista estructural y visualmente desenvuelta que no oprime ningún tipo de espacio.



FUROSHIKI

design
year

e-ggs
2020





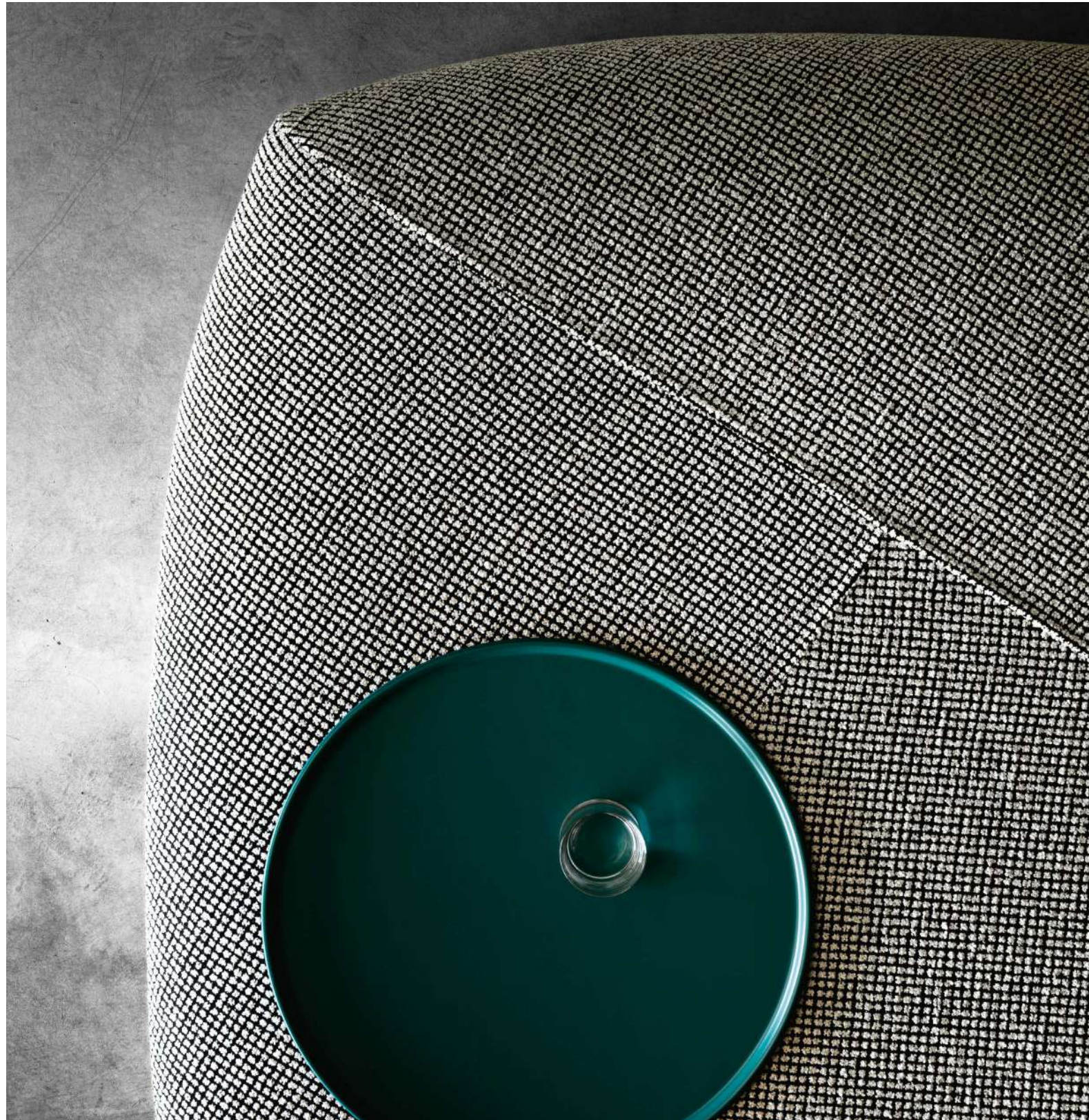

Furoshiki è un gioco di pattern e colori. Un involucro di stoffa confeziona l'imbottitura con una geometria rigorosa e una delicatezza tutta orientale. Le cuciture diventano dettagli sartoriali, suddividendo in porzioni precise l'oggetto. Così, le trame e i colori dei tessuti si guardano e si incontrano per poi proseguire in direzioni opposte.

EN Furoshiki is an interplay of patterns and colours. The fabric upholstery covers the padded seat with precise geometries and an unequivocally oriental delicacy. The seams become sartorial details, dividing the item into precise segments. The weave and colours of the fabrics meet and greet one another, then continue in opposite directions.

FR Furoshiki est un jeu de motifs et de couleurs. Une enveloppe en tissu constitue le rembourrage avec une géométrie rigoureuse et une délicatesse toute orientale. Les coutures deviennent des détails de style, en divisant l'objet en portions précises. Ainsi, les trames et les couleurs des tissus se croisent et se répondent, puis continuent dans des directions opposées.

DE Furoshiki ist ein Spiel aus Mustern und Farben. Eine Hülle aus Stoff umgibt die Polsterung mit rigoroser Geometrie und einer typisch östlichen Zartheit der Farben. Die Nähte werden zu kunstvollen Details, die das Objekt in exakte Quoten unterteilen. Texturen und Farben der Stoffe stehen sich gegenüber, treffen sich und setzen sich in entgegengesetzten Richtungen fort.

ES Furoshiki es un juego de estampados y colores. Un revestimiento de tela envuelve el relleno con una geometría rigurosa y una delicadeza muy oriental. Las costuras se convierten en detalles de confección que dividen el objeto en porciones precisas. Así, las tramas y los colores de los tejidos se miran y se encuentran para seguir después en sentidos opuestos.



The biggest space dedicated to our rest and relaxation: once the reserve of night readers and tired workers, for us it remains a restorative space, for more than just the body.



Shiko Wien
Bed

Ozz
Lamp

Furoshiki
Pouf

Soda
Coffee Table

SHIKO

Lo Shiko è un rito dei lottatori di Sumo che consiste nell'alzare la gamba e poi sbatterla a terra con energia per mandare via gli spiriti cattivi. Come quel rito, abbiamo disegnato un letto che evoca solidità e sicurezza, che trova nella morbidezza della testiera la sua forza.

EN Shiko is a ritual exercise performed by Sumo wrestlers, which involves lifting the legs and stomping hard on the floor to chase away evil spirits. Like that ritual, we have designed a bed that evokes a sense of solidity and safety. Its strength lies in the softness of its headboard.

FR Le Shiko est un rituel des lutteurs de Sumo qui consiste à lever la jambe et à frapper le sol du pied, avec énergie, pour chasser les esprits. Comme ce rituel, nous avons dessiné un lit qui évoque la solidité et la sécurité et qui trouve dans le moelleux de la tête de lit toute sa force.

DE Shiko ist ein Ritual der Sumö-Ringer, das aus einer stampfenden Bewegung der Füße besteht und böse Geister vertreiben soll. Wie dieses Ritual, strahlt das von uns entworfene Bett Solidität und Sicherheit aus und hat im kuscheligen Kopfteil seine besondere Stärke.

ES El Shiko es un rito de los luchadores de Sumo que consiste en levantar la pierna y luego dejarla caer con energía contra el suelo para alejar a los malos espíritus. Como ese rito, hemos diseñado una cama que evoca solidez y seguridad, que encuentra su fuerza en la suavidad del cabezal.



Shiko Wien Bed

Qzz Wall S Lamp

Soda Coffee table

Pelleossa Chair



Shiko Wien
Bed



Shiko Wonder
Bed



Ozz
Lamp

Shiko Wonder
Bed

Illo
Coffee table

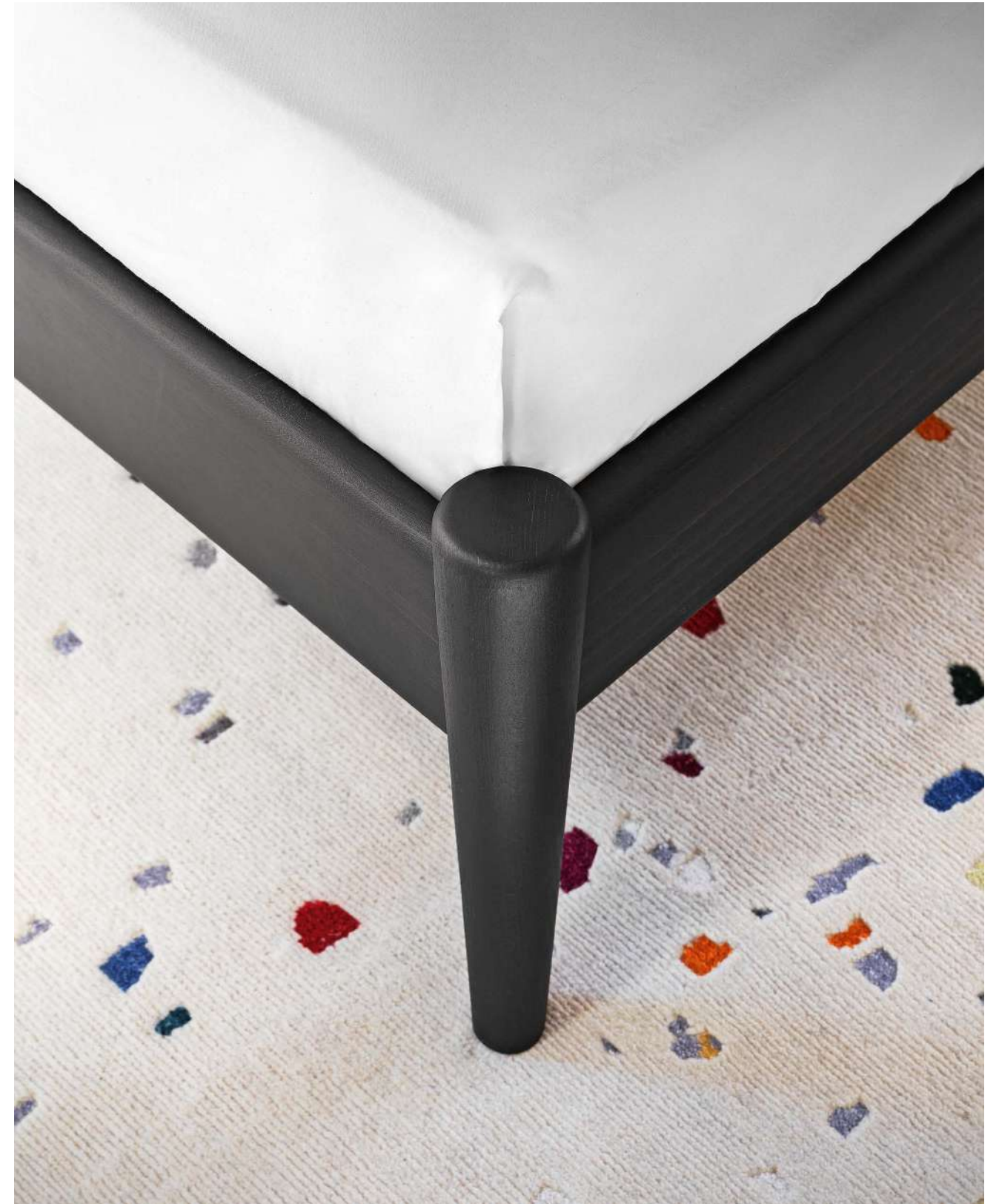

Shiko Wonder
Bed



Illo
Coffee table

Shiko Magnum
Bed

Boterina
Armchair

Ozz
Lamp



Once you have quelled your fear of the dark, it's time to create some atmosphere. From first light to nightfall, every moment has its own desires: are you ready to express yours?

154—185

LAMPADE

Lamps
Lampes
Lampen
Lâmparas



OZZ

design
year

Paolo Cappello
con Simone Sabatti
2019





Ozz
Lamp

Colony
Armchair

Ozz funziona in molti modi. Da una forma che ricorda un diapason, si sviluppano due elementi, una lampada e un vassoio porta oggetti, che si guardano e dialogano con un ritmo ben definito: il ritmo della luce. Se da spenta Ozz funziona come tavolino, da accesa crea uno spazio accogliente, dove la luce si stringe attorno al piano, entrando nell'intimità della casa. Ozz dà il La ai tuoi racconti domestici.

EN Ozz works in many ways. Two elements, a lamp and a small trinkets tray, supported by a shape reminiscent of a tuning fork, face each other and seem to dialogue in a well-defined rhythm, the rhythm of light. When Ozz is switched off, it serves as a small coffee table; when the lamp is on, it creates a warm, welcoming space where light seems to gather around the top, creating a homely intimacy. Ozz strikes a cheerful note in your home's narratives.

FR Ozz joue sur plusieurs registres. D'une forme qui rappelle un diapason, deux éléments se développent, une lampe et un plateau porte-objets, qui se regardent et dialoguent avec un rythme bien défini : le rythme de la lumière. Éteinte, Ozz fonctionne comme table basse, allumée, elle crée un espace accueillant, où la lumière se serre autour du plateau, en entrant dans l'intimité de la maison. Ozz donne le «la» à votre narration domestique.

DE Ozz funktioniert auf viele Arten. Aus einer Form, die einer Stimmgabel ähnlich ist, entwickeln sich zwei einander gegenüberliegende Elemente, eine Lampe und eine Ablage, die ihren Dialog in einem von Licht definierten Rhythmus führen. Ausgeschaltet ist Ozz ein Tischchen, eingeschaltet entsteht ein anheimelnder Bereich, wo sich das Licht um die Platte sammelt und in die Intimsphäre der Wohnung eintritt. Ozz gibt den Ton in den häuslichen Erzählungen vor.

ES Ozz funciona de muchas maneras. A partir de una forma que recuerda a un diapasón, se desarrollan dos elementos, una lámpara y una bandeja para apoyar objetos, que se miran y dialogan con un ritmo bien definido: el ritmo de la luz. Cuando se apaga, Ozz funciona como una mesa de centro, cuando se enciende crea un espacio acogedor, donde la luz se expande alrededor del tablero, entrando en la intimidad de la casa. Ozz da inicio a tus narraciones domésticas.



Ozz Floor
Lamp

Pelleossa
Chair

OZZ FLOOR

design
year

Paolo Cappello
con Simone Sabatti
2020

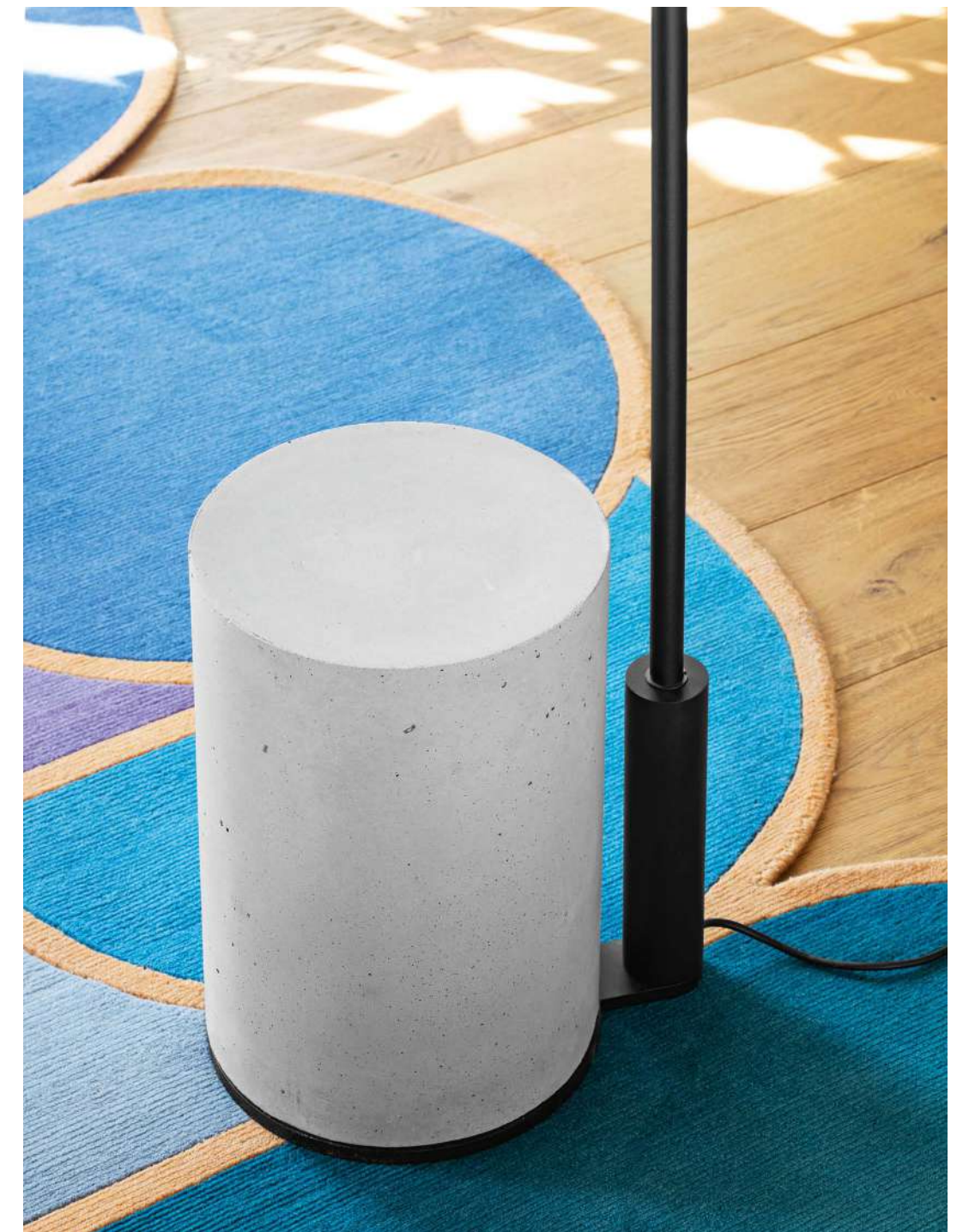



Ozz Floor
Lamp

Milonga
Bookshelve

Furoshiki
Pouf

Soda
Coffee table

Ozz diventa luce e pietra. Si sposta dall'intimità domestica al centro della casa, mostrandosi protagonista dello spazio con un grande arco che porta l'attenzione su di sé. Il disegno inizia nel calcestruzzo e finisce nel paralume. In mezzo, il fusto si flette con una parabola scenografica che fa abboccare la luce. Ozz conquista anche la zona pranzo, proponendosi come lampada a muro. L'arco si stringe e si inserisce nella parete, posizionandosi anche nell'home-office più ricercato.

EN Ozz is made of light and stone. It shifts from shy domesticity to become central to the home, proving itself a key figure, with its large, look-at-me arc. The design starts in the concrete and ends in the lampshade. Between the two, the shaft curves in a dramatic trajectory until the point where the light bites the bait. Ozz is also a winner at the dining table, where it becomes a wall lamp with a shorter arc that would look equally at home in the most elegant study.

FR Ozz devient lumière et pierre. Elle se déplace de l'intimité domestique vers le cœur de la maison, en se montrant protagoniste de l'espace avec un grand arc qui attire l'attention. Le dessin commence dans le béton et se termine dans l'abat-jour. Au milieu, la structure fléchit avec une parabole scénographique qui capte la lumière. Ozz s'impose aussi dans la zone repas en se proposant comme lampe murale. L'arc se resserre et s'insère dans le mur en trouvant aussi sa place dans l'home-office le plus raffiné.

DE Ozz wird zu Licht und Stein. Von der Privatsphäre in das Zentrum des Hauses, übernimmt Ozz, mit einem großen Bogen, der die Blicke auf sich zieht, die führende Rolle im Raum. Ein Design, das im Zement beginnt und im Lampenschirm endet. Dazwischen biegt sich der Stamm in einer filmreifen Parabel und angelt sich das Licht. Ozz wird zur Wandleuchte und erobert auch die Essecke. Der Bogen zieht sich zusammen und fügt sich in die Wand ein, ist aber eine elegante Präsenz auch im Home Office.

ES Ozz se convierte en luz y piedra. Se traslada de la intimidad doméstica al centro de la casa, mostrándose protagonista del espacio con un gran arco que atrae la atención sobre sí mismo. El diseño empieza en el hormigón y termina en la pantalla. En medio, el brazo se arquea con una parábola escenográfica que deja caer la luz. Ozz conquista también el comedor, proponiéndose como lámpara de pared. El arco se reduce y se introduce en la pared, y se puede colocar también en el estudio más exclusivo.



Ozz Wall
Lamp

Decapo
Table

Pelleossa
Chair

OZZ WALL

design
year

Paolo Cappello
con Simone Sabatti
2020





Ozz conquista anche la zona pranzo, proponendosi come lampada a muro. L'arco si stringe e si inserisce nella parete, posizionandosi anche nell'home-office più ricercato.

EN Ozz is also a winner at the dining table, where it becomes a wall lamp with a shorter arc that would look equally at home in the most elegant study.

FR Ozz s'impose aussi dans la zone repas en se proposant comme lampe murale. L'arc se resserre et s'insère dans le mur en trouvant aussi sa place dans l'home-office le plus raffiné.

DE Ozz wird zur Wandleuchte und erobert auch die Essecke. Der Bogen zieht sich zusammen und fügt sich in die Wand ein, ist aber eine elegante Präsenz auch im Home Office.

ES Ozz conquista también el comedor, proponiéndose como lámpara de pared. El arco se reduce y se introduce en la pared, y se puede colocar también en el estudio más exclusivo.



Ozz Desk
Lamp

Jumbo
Console

OZZ DESK

Pare che Ozz sia diventata timida: eccola nella versione da scrivania con cappello orientabile, per essere flessibile pur occupando il minimo spazio. Il contrappeso risulta fondamentale anche nelle piccole dimensioni, mantenendo un sempre intenso dialogo con il paralume, visibile in un insolito gioco di forme. Ancora più godibile, nella sua praticità.

EN It seems Ozz has gone shy: here it is in the desk version with adjustable shade, making it flexible while taking up minimal space. The counterweight is fundamental even in these small dimensions, maintaining a constant, intense interaction with the lampshade, and creating an original interplay between the shapes. Even more enjoyable in its practicality.

FR Il semblerait qu'Ozz soit devenue plus timide : la voici dans la version de bureau avec calotte orientable, pour être flexible tout en occupant le moins de place possible. Le contrepoids est fondamental même dans les petites dimensions, en maintenant un dialogue toujours intense avec l'abat-jour, visible dans un jeu de formes insolite. Encore plus plaisant dans sa commodité.

DE Ist Ozz schüchtern geworden? Hier, in der neuen Version als Schreibpult mit schwenkbarer Deckplatte, ist sie flexibel auf kleinstem Raum. Der Gegengewicht ist wesentlich auch bei kleinen Größen und der intensive Dialog mit der Lampe bleibt aufrecht, die in einem ungewöhnlichen Formenspiel zu sehen ist. Noch erfreulicher, in dieser praktischen Ausführung.

ES Parece que Ozz se haya vuelto tímida: aquí está en la versión de escritorio con pantalla orientable, para ser flexible aun ocupando el mínimo espacio. El contrapeso resulta fundamental incluso con el tamaño reducido, y mantiene siempre un intenso diálogo con la pantalla, visible en un insólito juego de formas. Todavía más atractiva, en su practicidad.

design
year

Paolo Cappello
con Simone Sabatti
2021



Ozz Wall S
Lamp

Shiko Wien
Bed

OZZ WALL S

design
year

Paolo Cappello
con Simone Sabatti
2021

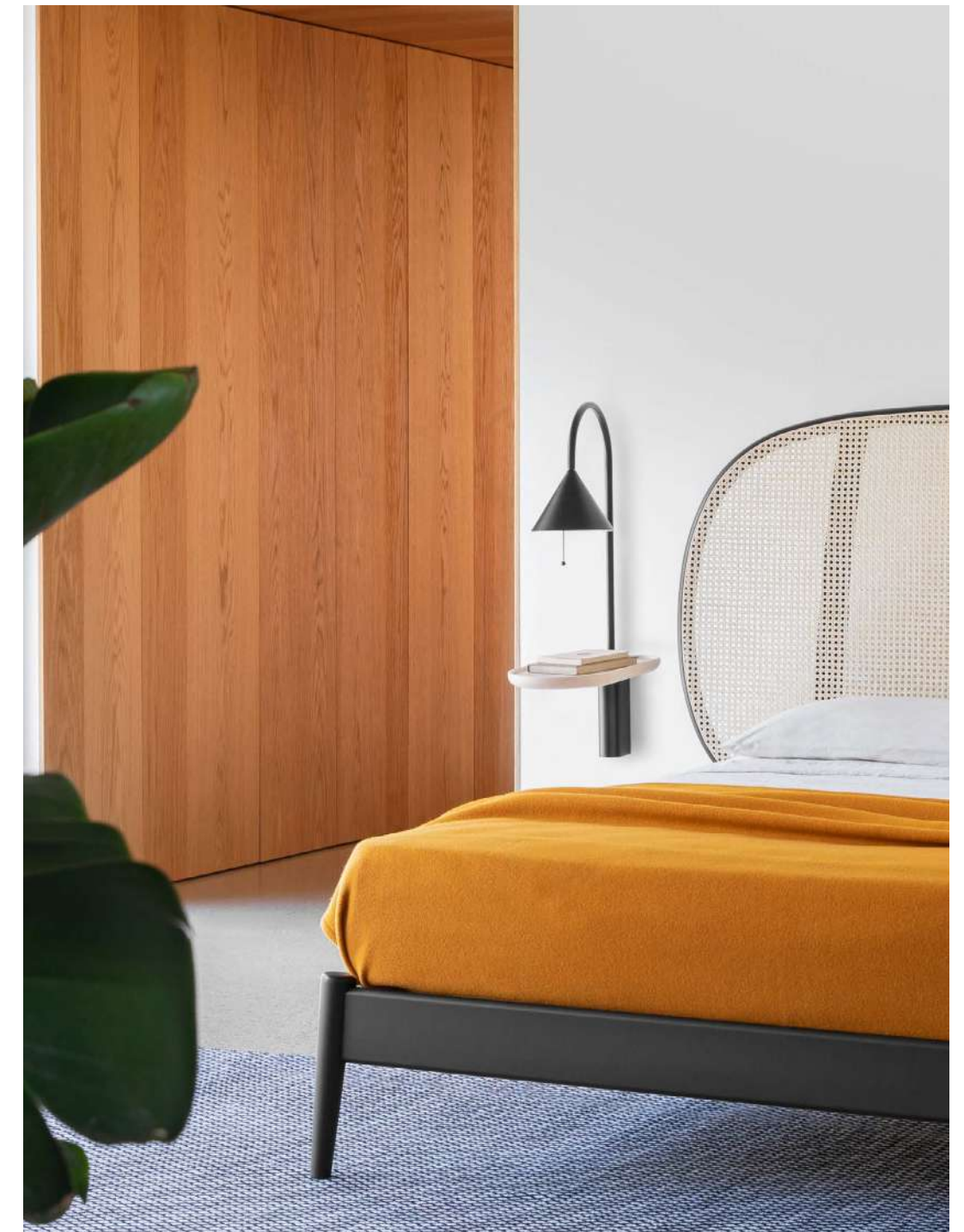



Una Ozz più discreta, ma con il solito temperamento. Nella taglia S si rende longilinea: l'arco si restringe e l'altezza aumenta, per farsi notare anche nella funzione di comodino in camera da letto. Nella versione full optional si fa accompagnare da un comodo ripiano, il quale avanza sulla scena diventando il palco di un nuovo spettacolo, dove la luce rimane indiscussa protagonista.

EN A more discreet Ozz, but with the usual temperament. In size S it grows longer: the arch narrows as the height increases, getting itself noticed in this role as a bedside table. In the full-option version it is fitted with a handy shelf, which projects into the room to form the stage for a new show, in which light plays the leading role.

FR Une Ozz plus discrète, mais toujours avec le même tempérament. Dans la taille S elle devient longiligne : l'arc se resserre et la hauteur augmente, pour se distinguer également au chevet du lit dans la chambre. Dans la version full option, elle est accompagnée d'une étagère, qui se projette vers l'avant en devenant la scène d'un nouveau spectacle, où la lumière reste incontestablement la vedette.

DE Ozz ist hier diskreter, aber temperamentvoll wie immer. In der Größe S nimmt die Länge zu: Der Bogen verengt sich und die Höhe steigt; auch als Nachtkästchen im Schlafzimmer will man auffallen. In der Ausführung full optional gibt es auch eine praktische Ablage, die sich in Szene setzt und zur Bühne für ein neues Schauspiel wird, wo Licht der eindeutige Superstar ist.

ES Una Ozz más discreta, pero con el temperamento de siempre. En la medida S se hace alargada: el arco se reduce y la altura aumenta, para destacar también sobre el comodín del dormitorio. En la versión full option va acompañada de un cómodo rellano que avanza en la escena para convertirse en el palco de un nuevo espectáculo, donde la luz sigue siendo la protagonista indiscutible.



ECLIPSE

Eclipse è una lampada estremamente dinamica, che dialoga con l'ambiente con una voce dal timbro squillante, vivace, che sorprende. Realizzata completamente in ceramica, dona al tatto la piacevole sensazione materica che il materiale offre.

EN Eclipse is an extremely dynamic lamp that interacts with the environment in a bright, lively voice that surprises. It is made entirely of ceramic, and the material offers a pleasant feeling to the touch.

FR Eclipse est une lampe extrêmement dynamique, qui dialogue avec son environnement d'une voix au timbre aigu, vif, qui surprend. Fabriquée entièrement en céramique, elle donne au toucher la sensation agréable de sa matière.

DE Eclipse ist eine besonders dynamische Lampe, die auf eine schrille, lebendige und überraschende Weise mit der Umgebung im Dialog steht. Die Lampe besteht zur Gänze aus Keramik und das Material sorgt beim Anfassen für ein angenehmes stoffliches Gefühl.

ES Eclipse es una lámpara extremadamente dinámica, que comunica con el espacio con voz sonora y vivaz, que sorprende. Realizada totalmente en cerámica, proporciona al tacto una placentera sensación matérica.



DENT

Un tubo schiacciato e deformato è la prerogativa dello studio di Dent, una eterea lampada a sospensione dove l'impiego del legno e della ceramica rende il risultato unico ed estremamente delicato. È disponibile in due diverse dimensioni.

EN A crushed, deformed tube is the concept behind Dent, an ethereal pendant lamp made from wood and ceramic with a unique, extremely delicate shape. Available in two different sizes.

FR Un tube écrasé et déformé est à la base du développement de Dent, une suspension aérienne où l'association du bois et de la céramique crée un résultat unique et extrêmement délicat. Elle est disponible en deux dimensions différentes.

DE Ein zusammengedrücktes, entsprechend geformtes Rohr ist die Basis für das Design von Dent, eine ätherische Deckenleuchte, die aus der Kombination von Holz und Keramik die besondere Wirkung von äußerster Zartheit bezieht. Erhältlich in zwei verschiedenen Abmessungen.

ES Un tubo aplanado y deformado es la prerogativa del estudio de Dent, una lámpara de techo etérea donde el uso de madera y cerámica hace que el resultado sea único y extremadamente delicado. Está disponible en dos tamaños diferentes.



TORA

Tora è una lampada a sospensione in ceramica, dalle tinte pastello opaco, che si ispira alle lanterne arabe e alle vecchie lanterne ad olio, adatta ad un uso sia domestico che contract. È pensata per essere utilizzata sia singolarmente che in gruppo.

EN Tora, a ceramic pendant lamp in matt pastel colours, draws its inspiration from Arab lanterns and old oil lamps. Designed to be used individually as well as in clusters, in both residential and contract settings.

FR Tora est une suspension en céramique, dans des teintes pastel mates, qui s'inspire des lanternes arabes et des vieilles lampes à huile et est adaptée aussi bien à l'espace domestique qu'aux espaces collectifs. Elle est conçue pour être utilisée soit seule soit en groupe.

DE Tora, eine keramische Deckenleuchte in matten Pastellfarben, bezieht ihre Anregung von arabischen Laternen und alten Petroleumlampen; sie ist sowohl für Wohnungs- als auch Objekteinrichtungen geeignet. Tora kann einzeln oder gruppenweise eingesetzt werden.

ES Tora es una lámpara de techo de cerámica, de tonos pastel mate, inspirada en los faroles árabes y en los antiguos faroles de aceite, apta tanto para uso doméstico como profesional. Está diseñada para utilizar sola o en grupo.

design
year

Paolo Cappello
2015



KIKI

Kiki è una lampada a sospensione in ceramica, dalle tinte pastello opaco, che reinterpreta la classica forma a campana adatta ad un uso sia domestico che contract. Kiki è pensata per essere usata sia singolarmente che in gruppo.

EN Kiki, a ceramic pendant lamp in matt pastel colours, reinterprets the classic bell shape. Kiki is designed to be used individually as well as in clusters, in both residential and contract settings.

FR Kiki est une suspension en céramique, dans des teintes pastel mates, qui réinterprète la forme en cloche classique et est adaptée aussi bien à l'espace domestique qu'aux espaces collectifs. Elle est conçue pour être utilisée soit seule soit en groupe.

DE Kiki, eine keramische Deckenleuchte in matten Pastellfarben, greift die klassische Clockenform wieder auf; sie ist sowohl für Wohnungs- als auch Objekteinrichtungen geeignet. Kiki kann einzeln oder gruppenweise eingesetzt werden.

ES Kiki es una lámpara de techo de cerámica, con tonos pastel mate, que reinterpreta la clásica forma de campana apropiada tanto para uso doméstico como profesional. Kiki está diseñada para utilizar sola o en grupo.

design
year

Paolo Cappello
2015



SLOPE

Una famiglia di lampade nata dalla semplice idea di vestire la lampadina: un corpo in massello di legno e un paralume in metallo diventano l'essenziale fonte di luce.

EN A family of lamps born from the simple idea of dressing a light bulb: a solid wood body and a metal lampshade form an essential source of light.

FR Une famille de lampes née de la simple idée d'habiller l'ampoule: un corps en bois massif et un abat-jour en métal deviennent la source de lumière élémentaire.

DE Eine Linie von Lampen, entstanden aus der einfachen Idee, eine Glühbirne zu bekleiden: ein Körper aus Massivholz und ein Metallschirm werden zu einer schlichten Lichtquelle.

ES Una familia de lámparas que nace de la sencilla idea de vestir la bombilla: un cuerpo de madera maciza y una pantalla de metal pasan a ser la fuente esencial de luz.

design
year

Skrivo
2013





Extras that are simply essential: a series of supports for everyday life that carry out their duties without overlooking the pleasure of good design.

186—213

ACCESSORI

Accessories
Accessoires
Wohnaccessoires
Accesorios



COQUE

design
year

Alain Gilles
2020

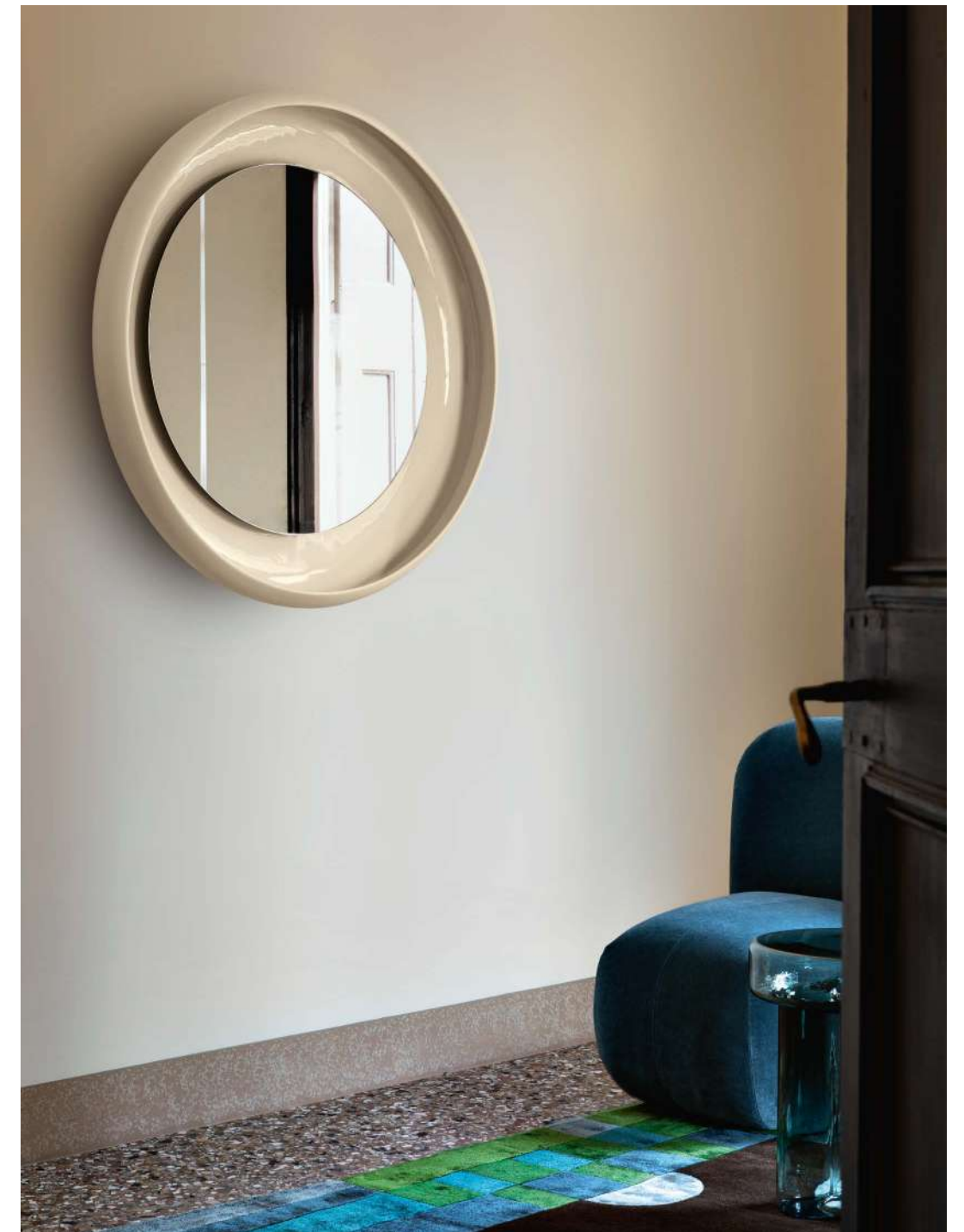



Coque ha un gusto dinamico e ricco di contrasti. Lo specchio è protetto da un guscio in ceramica, dove convivono due finiture opposte: lucido e opaco. La superficie dell'interno è smaltata e brillante mentre la buccia esterna si rivela materica. Lo specchio si trasforma in un oggetto prezioso che esalta i materiali naturali, dove i riflessi riverberano e danno significato al living.

EN Coque has a taste for dynamic, rich contrasts. The mirror is protected by a ceramic shell, which embraces two opposing finishes: glossy and matt. The inner surface is enamelled and shiny, while the outer skin is textured. The mirror is transformed into a precious object that accentuates the natural materials, with reflections that reverberate and add depth to the living space.

FR Coque a un style dynamique et plein de contrastes. Le miroir est protégé par une coque en céramique, où se côtoient deux finitions opposées : brillante et mate. La surface de la partie interne est émaillée et brillante tandis que le revêtement extérieur est texturé. Le miroir se transforme en un objet précieux qui met en valeur les matériaux naturels, où les reflets se multiplient et donnent un sens au living.

DE Coque ist stilistisch dynamisch und reich an Kontrasten. Der Spiegel wird von einem Keramikgehäuse geschützt, das zwei verschiedene Oberflächen aufweist: glänzend und matt. Die Innenseite ist glasiert und glänzend, die Außenschale ist stofflich matt. Der Spiegel wird zum edlen Objekt, das die natürlichen Materialien zur Geltung bringt, wo Reflexe zurückgeworfen werden und dem Wohnraum Sinn und Bedeutung geben.

ES Coque es de gusto dinámico y rico en contrastes. El espejo está protegido por una moldura de cerámica, en la que conviven dos acabados opuestos: brillante y opaco. La superficie interior está esmaltada y es brillante, mientras que la cara externa se revela matérica. El espejo se transforma en un objeto precioso que exalta los materiales naturales, donde los reflejos reverberan y dan significado a la sala de estar.



Les Brothers
Mirror

Link
Coffee table

LES BROTHERS

design
year

Paolo Cappello
2013





Les Brothers è una famiglia di specchi un po' particolare composta da sette fratelli, due grandi, due intermedi e tre piccoli. Se i due grandi amplificano ed estendono gli spazi, i piccoli donano dolcezza all'ambiente, mentre i medi cercano il dialogo tra le due funzioni. Gli accomuna un piccolo neo nella parte superiore, un dettaglio in legno che diventa il supporto al muro.

EN Les Brothers is a family of rather special mirrors, made up of seven brothers, two large, two intermediate and three small. If the two large ones amplify and expand the space, the small ones add sweetness to the environment whilst the mid-sized ones seek a dialogue between the two functions. They share a small beauty spot on the upper part, a detail in wood that also acts as the wall mount.

FR Les Brothers est une famille de miroirs un peu particulière, composée de sept frères: deux grands, deux moyens et trois petits. Tandis que les deux grands frères agrandissent et étendent les espaces, les petits apportent de la délicatesse à la pièce dans laquelle ils se trouvent. Les moyens quant à eux prennent une place intermédiaire entre ces deux fonctions. Ils ont en commun un détail en bois, placé dans la partie supérieure tel un grain de beauté, qui permet de les accrocher au mur.

DE Les Brothers ist eine Familie aus besonderen Spiegeln, die sich aus sieben Geschwistern zusammensetzt: zwei große, zwei mittelgroße und drei kleine. Während die beiden großen Spiegel Räume erweitern und vergrößern, verleihen die kleinen Spiegel dem Raum Raffinertheit. Die mittelgroßen Spiegel suchen den Dialog zwischen den beiden Funktionen. Sie werden im oberen Bereich von einem Haken begleitet - ein Detail aus Holz, das zur Wandhalterung wird.

ES Les Brothers es una familia de espejos algo especial, compuesta por siete hermanos, dos grandes, dos medianos y tres pequeños. Mientras que los dos grandes amplían y dilatan el espacio, los pequeños dan un toque de suavidad a la estancia y los medianos buscan el diálogo entre las dos funciones. Todos están caracterizados por un pequeño neo en la parte superior, un detalle de madera que se convierte en el soporte de pared.



BENVENUTO

Ideale per risolvere situazioni d'ingresso, Benvenuto invita ad appoggiare le chiavi e appendere il cappotto, facendo dello specchio un complemento multifunzionale.

EN Perfect for solving the entrance hall issue: Benvenuto invites you to leave your keys, hang your coat, making the mirror a multi-functional accessory.

FR Idéal pour meubler de façon pratique l'entrée, Benvenuto invite à déposer ses clés et à accrocher son manteau, en transformant le miroir en un accessoire polyvalent.

DE Als ideale Lösung für den Eingangsbereich lädt Benvenuto dazu ein, die Schlüssel abzulegen und den Mantel aufzuhängen. Dabei wird der Spiegel zu einem multifunktionalen Einrichtungsgegenstand.

ES Ideal para decorar recibidores, Benvenuto invita a apoyar las llaves y colgar el abrigo, convirtiendo el espejo en un elemento multifuncional.



CIGALES

design
year

Paolo Cappello
2018





Cigales nasce per decorare con il verde e trasformare l'ambiente in una piccola oasi domestica. Per questo pensiamo che Cigales non sia solo un oggetto affascinante, ma la proposta di uno stile di vita positivo, che dialoga con l'equilibrio psicofisico dell'individuo. Disponibile freestanding, da parete e con specchio.

EN Cigales was made to decorate with greenery and to transform the environment into a small domestic oasis. That is why we think that Cigales is not just a charming piece but also an idea for a positive lifestyle, which converses with your psychophysical balance. Available in freestanding version, wall mounted or with mirror.

FR Cigales est né pour décorer et transformer la pièce dans laquelle il se trouve en une petite oasis domestique. C'est pour cette raison que nous considérons Cigales non seulement comme un objet fascinant, mais aussi comme une proposition pour un style de vie positif influençant l'équilibre psychophysique de l'individu. Disponible sur pied, en version murale et avec miroir.

DE Cigales entsteht, um mit Grün zu dekorieren und den Raum in eine kleine Oase für zuhause zu verwandeln. Daher sind wir der Meinung, dass Cigales nicht nur ein faszinierender Gegenstand, sondern ein Angebot für einen neuen, positiven Lebensstil ist, der mit dem psychisch-physischen Gleichgewicht des Individuums in Dialog tritt. Freistehend, zur Wandmontage und mit Spiegel erhältlich.

ES Cigales nació para decorar con «verde» y transformar la estancia en un pequeño oasis doméstico. Por esta razón, estamos convencidos de que Cigales no es únicamente un objeto cautivador, sino también una propuesta para un estilo de vida positivo, que dialoga con el equilibrio psicofísico de la persona. Disponible en versión freestanding, de pared y con espejo.



Colony Screen
Accessories
Shiko Wien
Blau

COLONY SCREEN

Abbiamo voluto valorizzare il ruolo nascosto del paravento nell'ambiente indoor, presentando un elemento fortemente scenografico che potrebbe uscire da qualche film di Wes Anderson. Sfruttando le trasparenze della paglia di vienna, Colony mostra una chiara e forte personalità, presentandosi come una figura che stupisce e attrae.

EN We wanted to enhance the overlooked role of the screen within the indoor environment, introducing a decidedly dramatic element that could have come from a Wes Anderson film. Taking advantage of the transparency of the cane, Colony shows a clear and strong personality, presenting itself as a figure that amazes and attracts.

FR Nous avons voulu mettre en valeur le rôle caché du paravent dans les espaces intérieurs en proposant un élément très décoratif qui semble tout droit sorti d'un film de Wes Anderson. Colony exploite les effets de transparence du cannage, pour affirmer un caractère fort et définiet en se présentant comme un produit qui surprend et séduit.

DE Wir wollten die in Innenbereichen untergeordnete Rolle des Paravents in Szene setzen, indem wir ein besonders stark szenografisches Element präsentieren, das aus einem Film von Wes Anderson stammen könnte. Durch das Nutzen der Transparenzeffekte des Wiener Geflechts verfügt Colony über eine klare und starke Persönlichkeit und zeigt sich als Figur, die verwundert und anzieht.

ES Hemos querido valorar el rol oculto del biombo en la decoración de interiores, presentando un elemento intensamente escenográfico que podría pertenecer perfectamente a una de las películas de Wes Anderson. Aprovechando la transparencia de la paja de Viena, Colony revela su personalidad fuerte y definida, presentándose como un elemento que sorprende y cautiva.



Came Of Trust
Accessories

Mariolina Office
Chair

GAME OF TRUST

Tre elementi a forma di Y si supportano a vicenda, trovando insieme un equilibrio decisamente sicuro. Game of Trust diventa così un appendiabiti iconico e scenografico, dove nessun componente è protagonista.

EN The three Y-shaped elements support each other, finding together an extremely stable balance. This makes Game of Trust an iconic, theatrical coat stand, where no component prevails.

FR Trois éléments en forme de Y se soutiennent mutuellement, trouvant ensemble un équilibre des plus sûrs. Game of Trust devient un portemanteau iconique et scénographique où aucun composant ne l'emporte sur l'autre.

DE Drei Elemente in Y-Form stützen sich gegenseitig und finden gemeinsam zu einem eindeutig sicheren Gleichgewicht. Game of Trust wird so zu einem ikonischen Kleiderständer, der sich gekonnt in Szene setzt, ohne dass eine der Komponenten zum Protagonisten wird.

ES Tres elementos en forma de Y se sostienen entre sí, consolidando juntos su propio equilibrio. Game of Trust se convierte así en un perchero icónico y escenográfico, donde ningún componente es protagonista.



BUBBLE

Piccole sfere in faggio sbucano da uno stelo colorato, contaminando con una personalità vivace l'appendiabiti tradizionale. È un complemento, che sostiene le tue sfide.

EN Small beech wood balls seem to appear from nowhere along a coloured stem, lending the traditional coat stand a vibrant personality. A complementary furnishing item that lives up to your challenges.

FR Une éclosion de petites sphères en hêtre sur une tige colorée contamine avec beaucoup de personnalité le portemanteau traditionnel. C'est un complément qui soutient vos défis.

DE Kleine Kugeln aus Buchenholz wachsen aus einem farbigen Ständer und erfüllen einen traditionellen Kleiderständer mit lebhafter Persönlichkeit. Ein Wohnzubehör, das dich nicht im Stich lässt.

ES Pequeñas esferas de haya brotan un tallo de color, contaminando el perchero tradicional con una personalidad arrolladora. Es un complemento que sostiene tus desafíos.

design
year

Skrivo
2014



Caio
Accessories

Furoshiki
Pouf

CAIO

Caio è un appendiabiti porta grucce smart e intuitivo. Trova il proprio spazio negli alberghi, come alternativa all'armadio tradizionale, e negli ingressi domestici, dialogando con una palette morbida e un disegno minimale.

EN Caio is a smart, intuitive coat hanger unit. It finds its own space in hotels, as an alternative to the traditional wardrobe, and in the entrance hall of a house, dialoguing with a soft palette and a minimalist design.

FR Caio est une penderie avec cintres intelligente et intuitive. Elle trouve sa place dans les hôtels, à la place de l'armoire traditionnelle et dans les entrées de maison, grâce à ses couleurs délicates et à sa forme minimaliste.

DE Caio ist ein smarter und intuitiver Kleiderständer mit Kleiderbügel. Er ist in Hotels, als Alternative zum klassischen Kleiderschrank, wie auch in Wohnhäusern anzutreffen. Anhand der zarten Farbpalette und des minimalen Designs tritt er mit den Räumen in Dialog.

ES Caio es un perchero inteligente e intuitivo. Es ideal para hoteles, como alternativa al armario tradicional, y en los recibidores de viviendas, dialogando con una paleta suave y un diseño minimalista.



CHiodo

design
year

Zaven
2013





Chiodo è un modo per puntellare la parete con grazia, trovando una soluzione alternativa all'appendiabito tradizionale.

EN Chiodo is a smart way to punctuate the wall gracefully, finding an alternative solution to traditional hangers.

FR Chiodo est une façon de consteller le mur avec élégance, tout en offrant une solution différente par rapport aux portemanteaux traditionnels.

DE Chiodo ist eine Art, um die Wand mit Anmut zu stützen, indem eine alternative Lösung zu traditionellen Kleiderhaken gefunden wurde.

ES Chiodo es una manera de decorar la pared con elegancia, encontrando una solución alternativa al perchero tradicional.

SCHEDE TECNICHE

TECHNICAL SHEETS

FICHES TECHNIQUES

TECHNISCHEN ANHÄNGEN

FICHAS TÉCNICAS

SCHEDE TECNICHE

TECHNICAL SHEETS

FICHES TECHNIQUES

TECHNISCHEN ANHÄNGEN

FICHAS TÉCNICAS

SCHEDE TECNICHE

TECHNICAL SHEETS

BRULLA

Design Skrivo

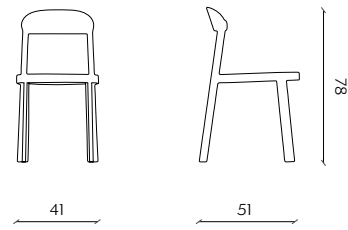

Struttura
Structure



Seduta
Seat



CLARETTA FAMILY

Design Florian Schmid

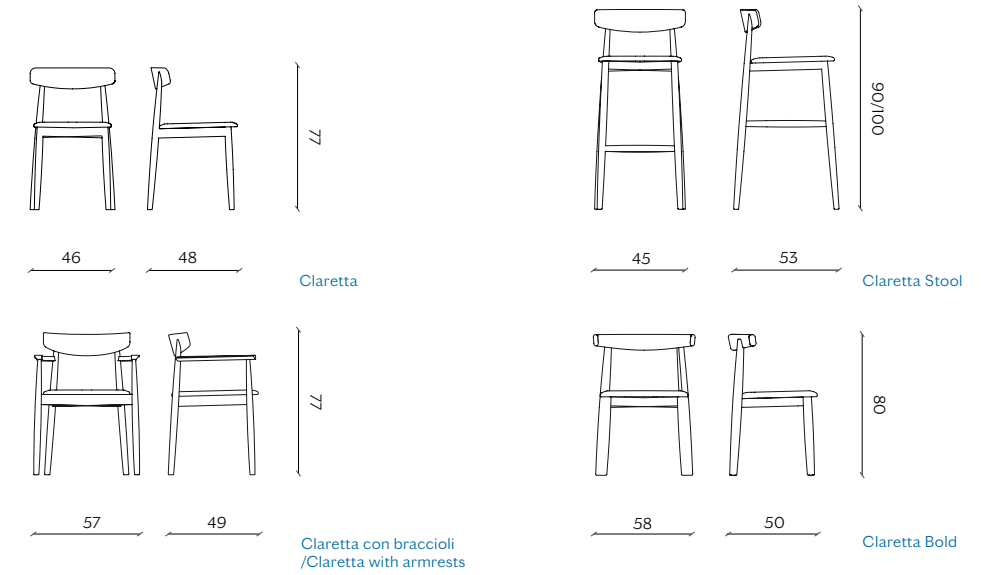

Tessuto
Fabric

— Tonalità nel Campionario
Shades on Campionario

✂️
Custom COM:
h1,40x0,3 Im
h1,40x0,4 Im Claretta Bold

Struttura
Structure

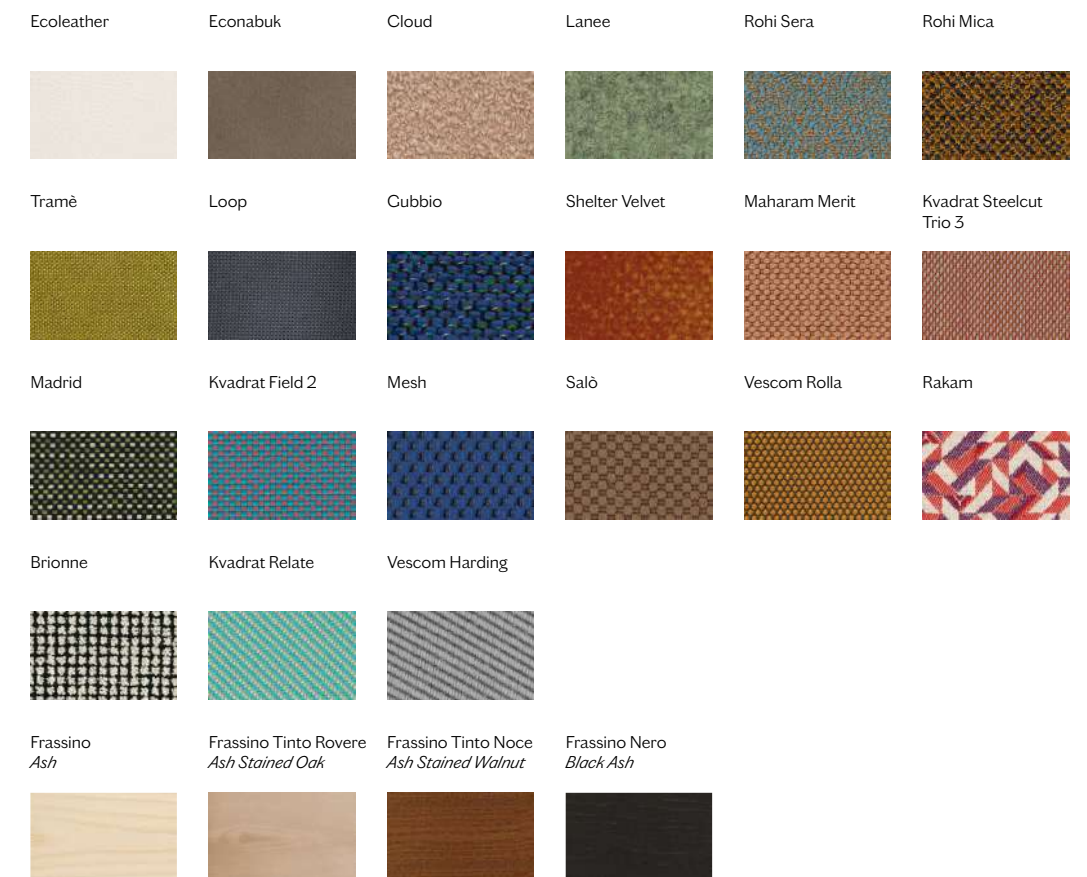

PELLEOSSA

Design Francesco Faccin

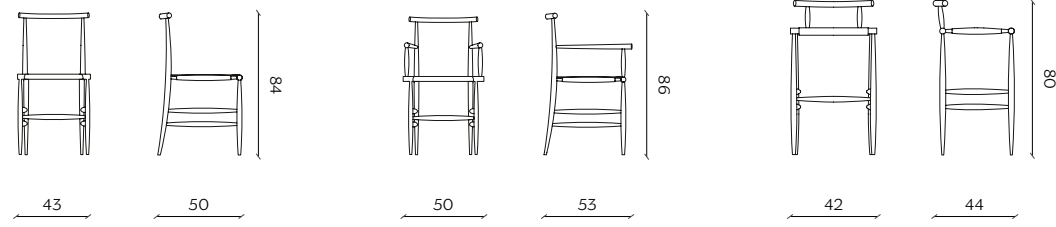

**Seduta
Seat**

Cuoio (8 colori)
Leather (8 tones)



Paglia di Fiume
Traditional Straw



**Struttura
Structure**

Rovere Fiammato
Flamed Oak



Rovere Tinto Noce
Oak Stained Walnut



Rovere Nero
Black Oak



DIVERGE

Design Skrivo

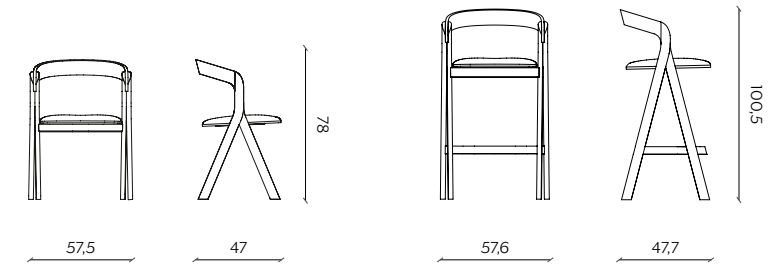

**Tessuto
Fabric**

— Tonalità nel Campionario
Shades on Campionario

Custom COM:
h1,40x0,7 lm

**Struttura
Structure**

Ecoleather



Econabuk



Cloud



Lanee



Rohi Sera



Rohi Mica



Tramè



Loop



Cubbio



Shelter Velvet



Maharam Merit



Kvadrat Steelcut
Trio 3



Madrid



Kvadrat Field 2

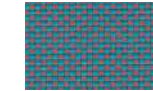

Mesh



Salò



Vescom Rolla



Rakam



Brionne

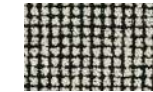

Kvadrat Relate



Vescom Harding

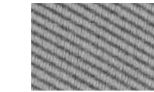

Frassino
Ash



Frassino Tinto Rovere
Ash Stained Oak



Frassino Tinto Noce
Ash Stained Walnut



Frassino Nero
Black Ash



TUBE

Design Ciopato&Coombes

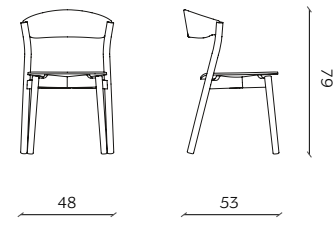

Tessuto
Fabric

— Tonalità nel Campionario
Shades on Campionario

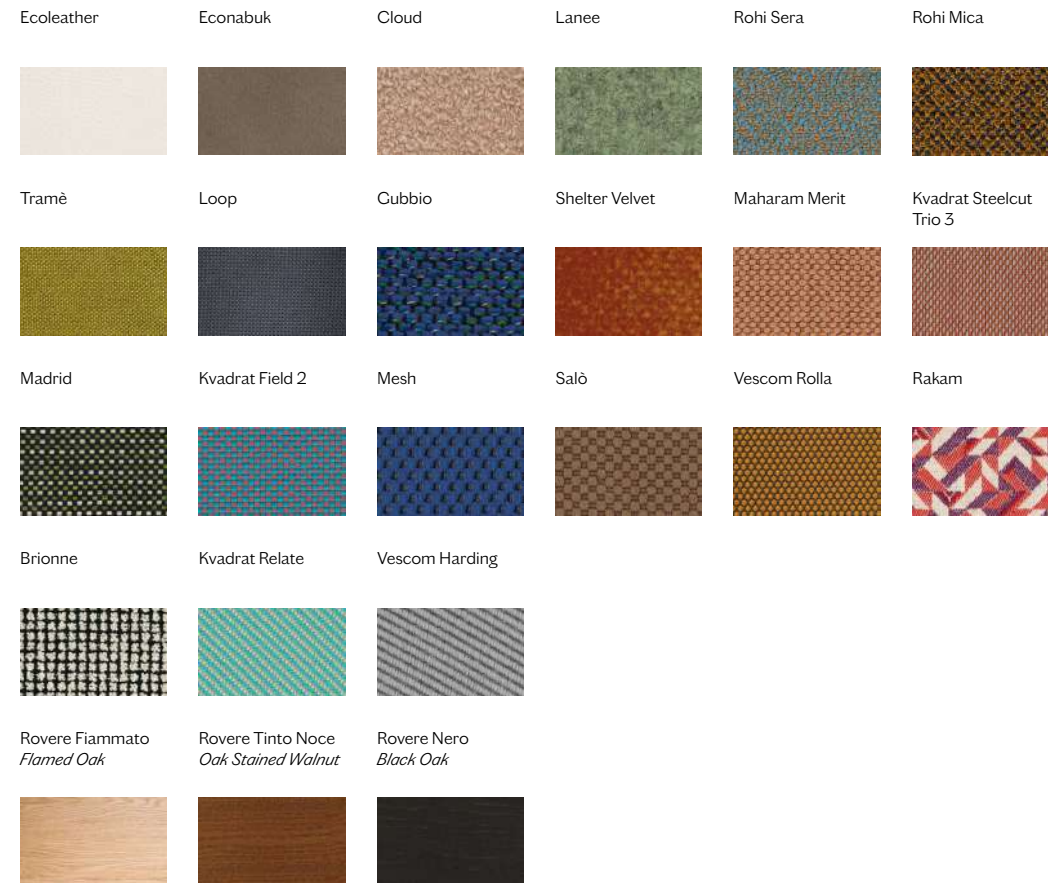

Struttura
Structure

Custom COM:
h1,40x0,3 Im

VALERIE

Design Ciopato&Coombes

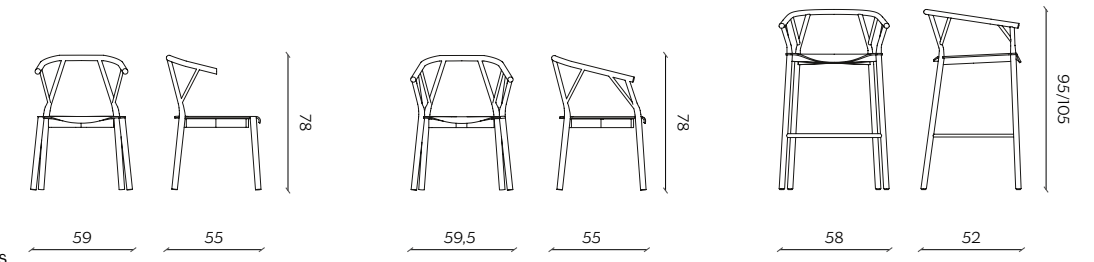

Tessuto
Fabric

— Tonalità nel Campionario
Shades on Campionario

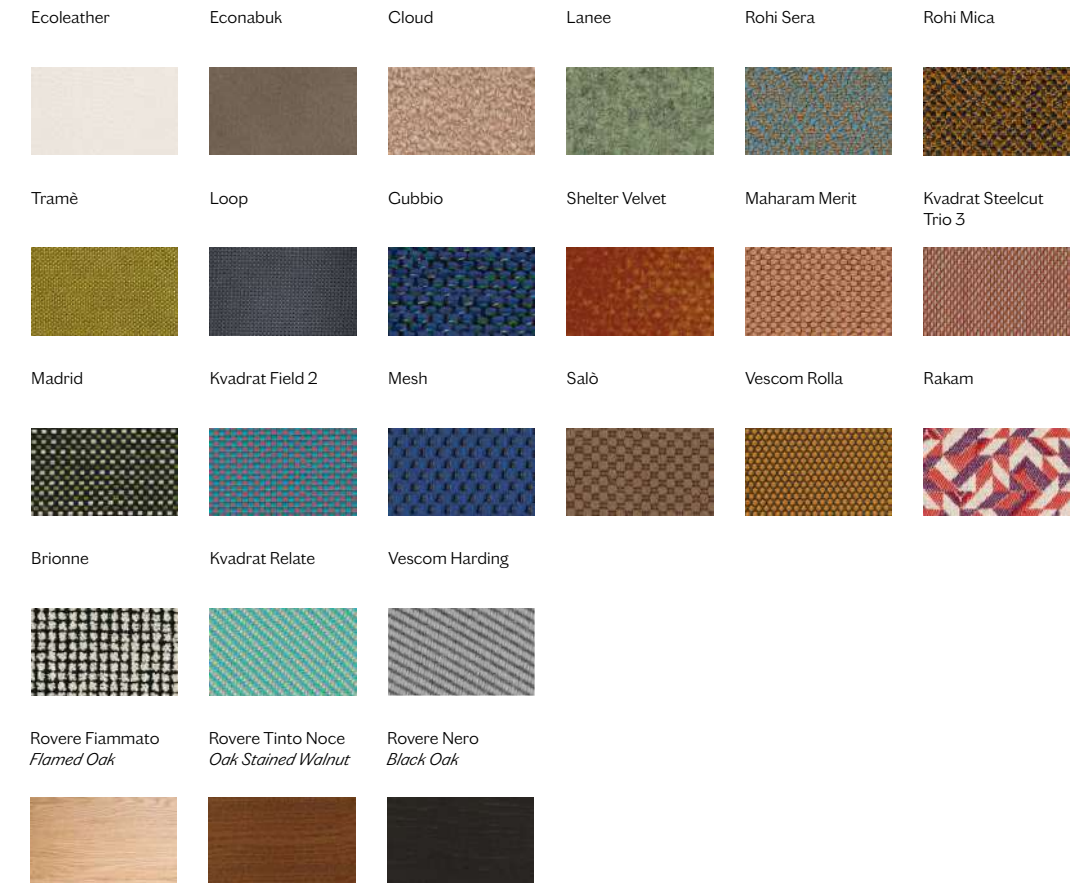

Struttura
Structure

Custom COM:
h1,40x0,4 Im

IOLA

Design e-ggs

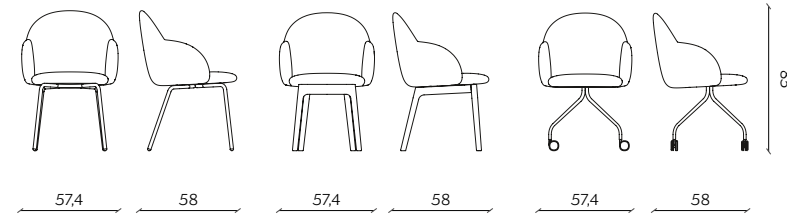
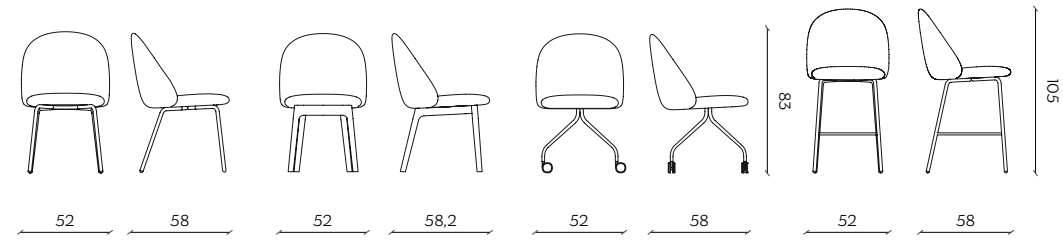

Disponibile nelle seguenti versioni
/Available in the following versions:
Basic, Wood, Office, Stool

Tessuto Fabric

— Tonalità nel Campionario
Shades on Campionario

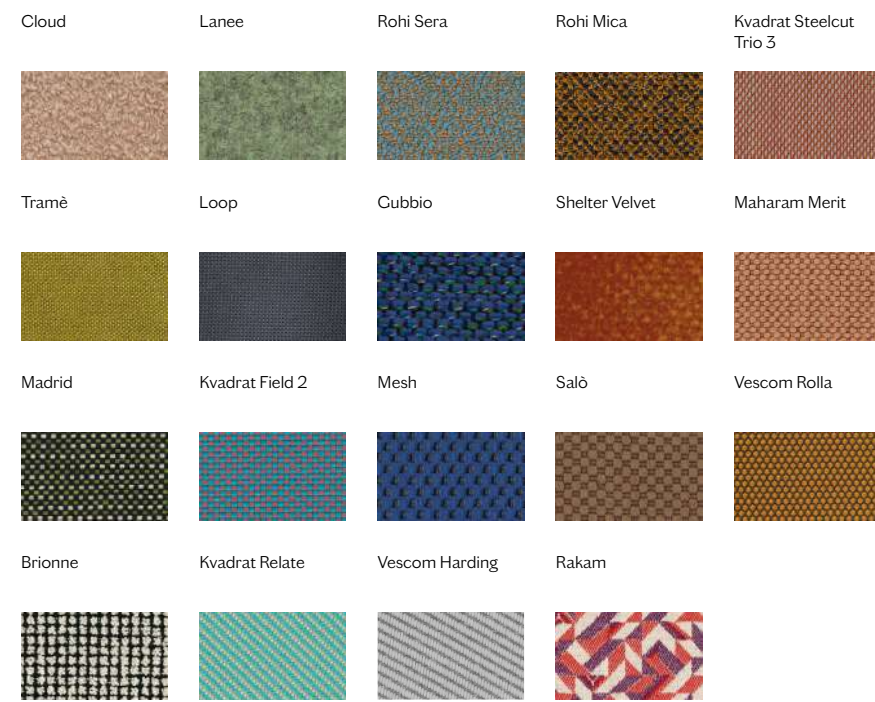

Custom COM:
h1,40x1,1 lm
h1,40x1,4 lm with armrests

Cambe Legno Wooden Legs

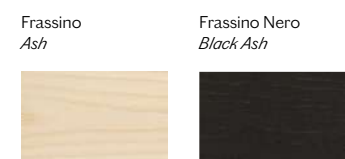

Cambe Ferro Iron Legs



Cambe Ufficio Office Legs

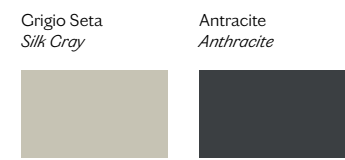

MULA

Design e-ggs

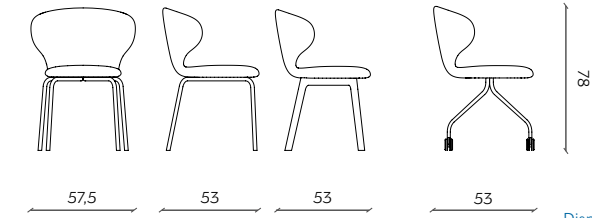

Disponibile nelle seguenti versioni
/Available in the following versions:
Basic, Wood, Office

Tessuto Fabric

— Tonalità nel Campionario
Shades on Campionario

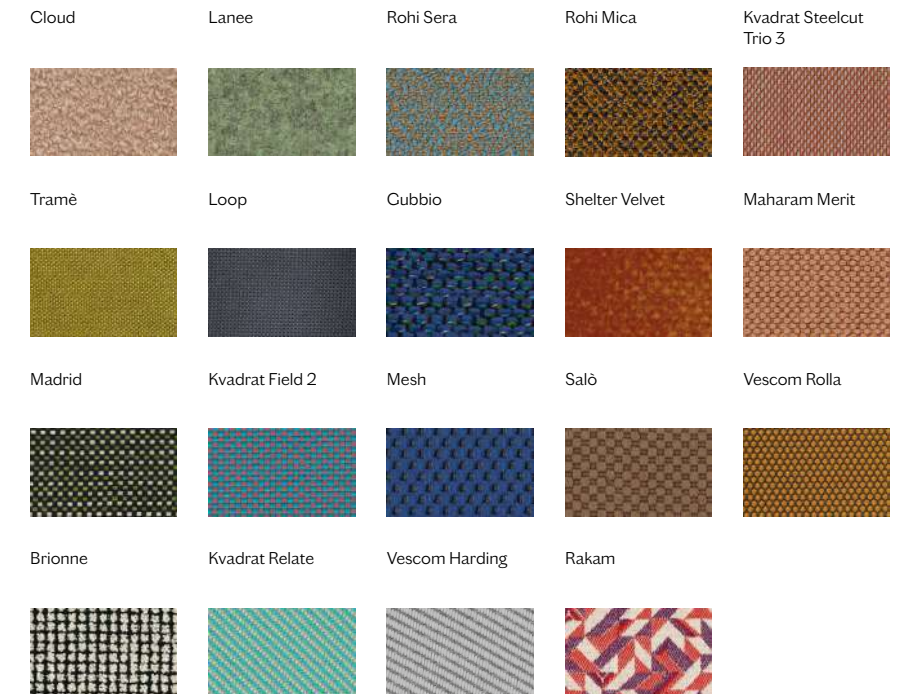

Custom COM:
h1,40x1,4 lm

Cambe Legno Wooden Legs

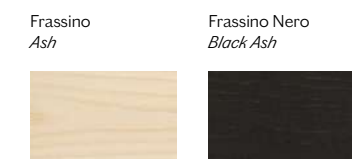

Cambe Ferro Iron Legs

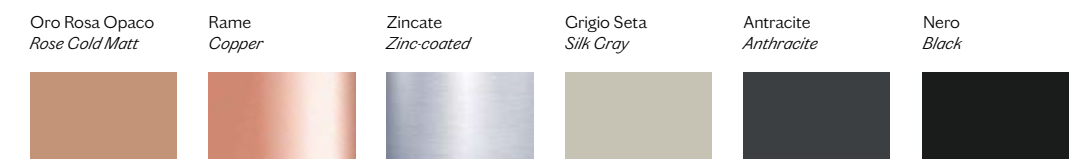

Cambe Ufficio Office Legs

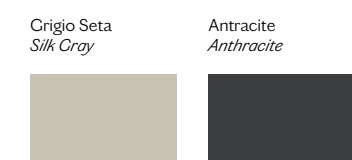

MARIOLINA

Design e-ggs

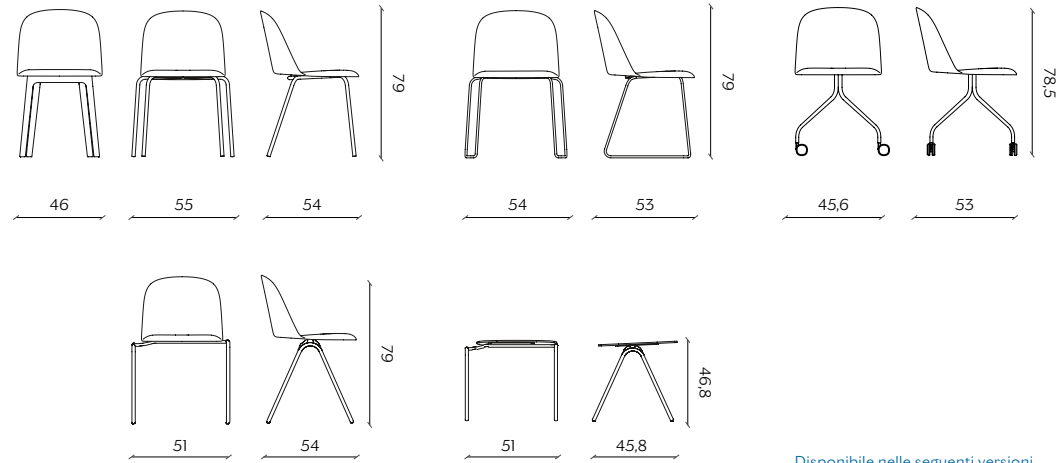

Disponibile nelle seguenti versioni
/Available in the following versions:
Wood, Basic, Sled, Office,
Edu with side table

Seduta Seat

— Tonalità nel Campionario
Shades on Campionario

Custom COM:
h1,40x0,4 lm basic and wood
h1,40x0,4 lm sled, office, edu

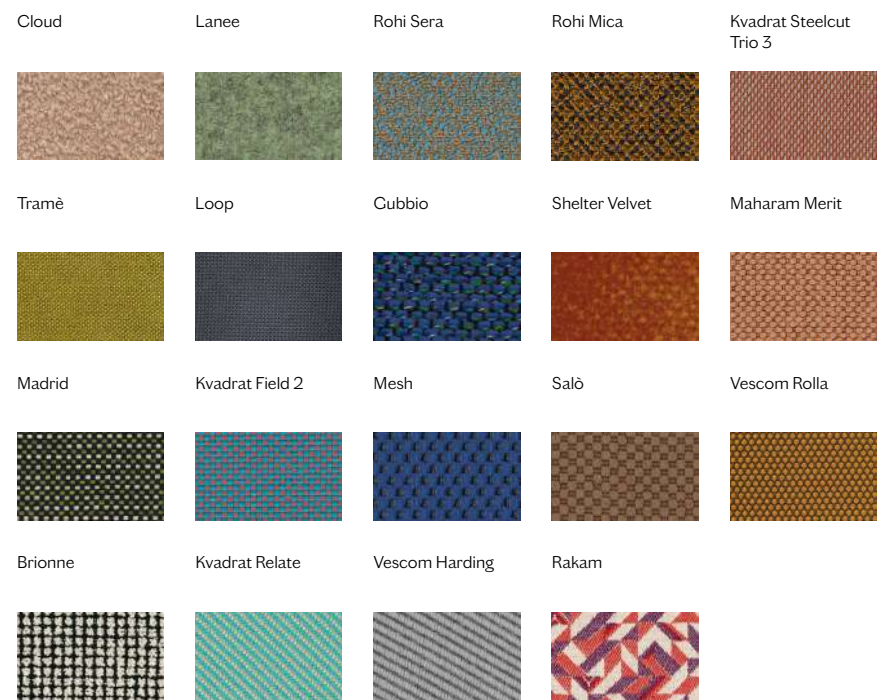

Scocca Shell



Cambe Legs

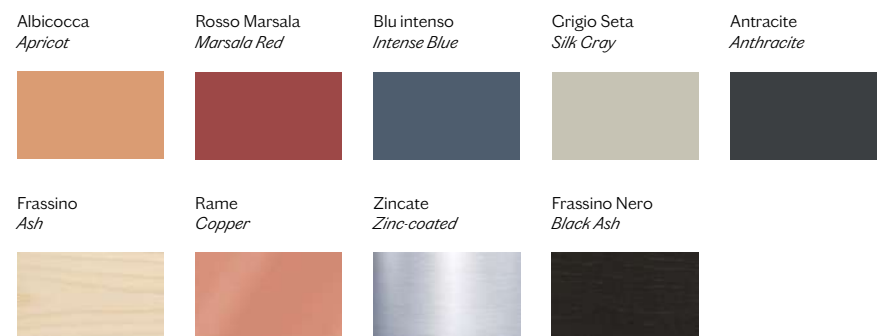

Edu e Slitta - disponibili solo con gambe
Antracite o Zincate
/only with Anthracite or Zinc-coated legs.
Office - disponibile solo con gambe
Antracite o Crigio Seta
/only with Anthracite or Silk Grey legs

LEDA

Design Francesco Beghetto

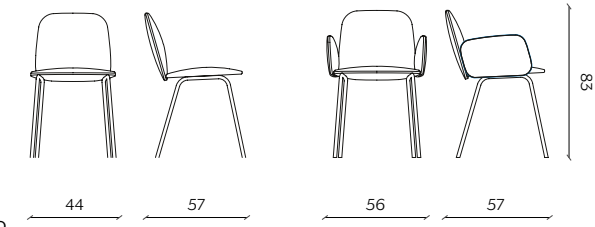

Tessuto Fabric

— Tonalità nel Campionario
Shades on Campionario

Custom COM:
h1,40x1,1 lm
h1,40x2,1 lm with armrests

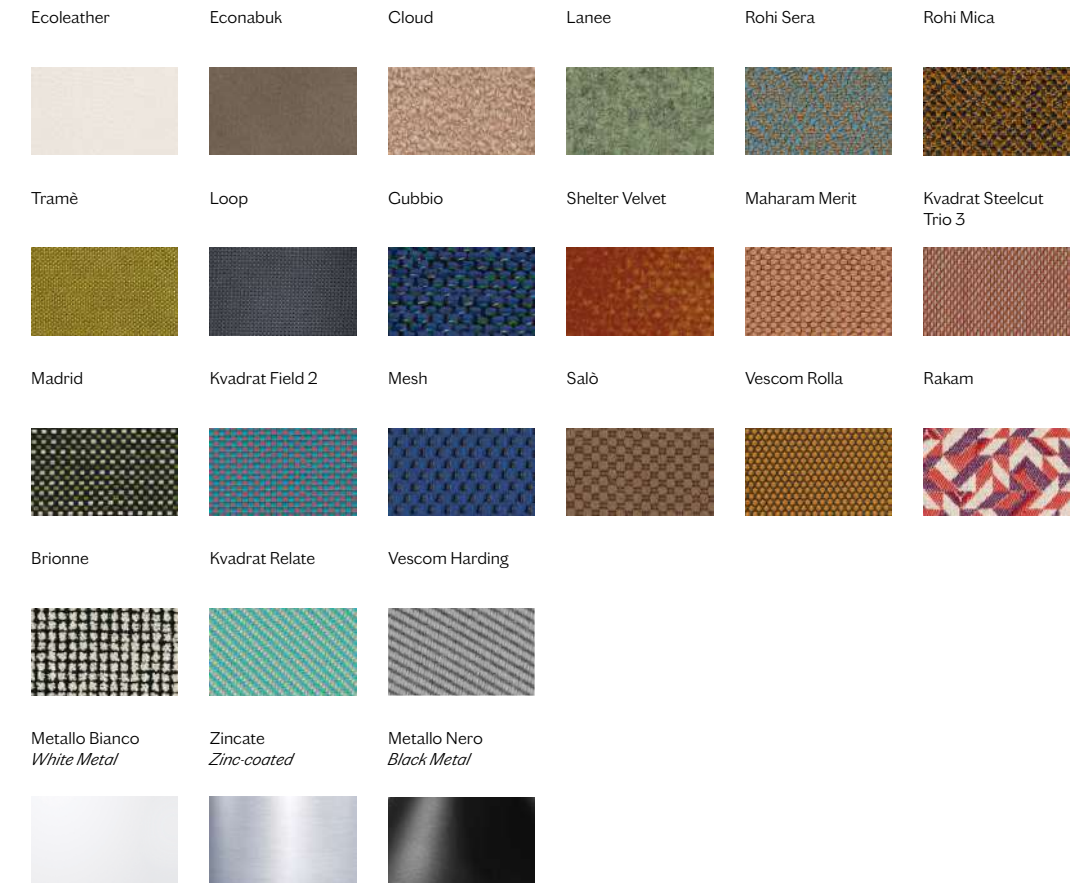

Struttura Structure

DUMBO

Design Zaven

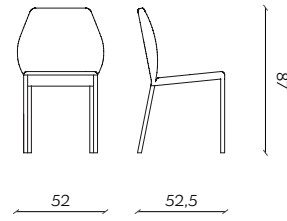

Tessuto Fabric

— Tonalità nel Campionario
Shades on Campionario



Custom COM:
h1,40x1,4 lm

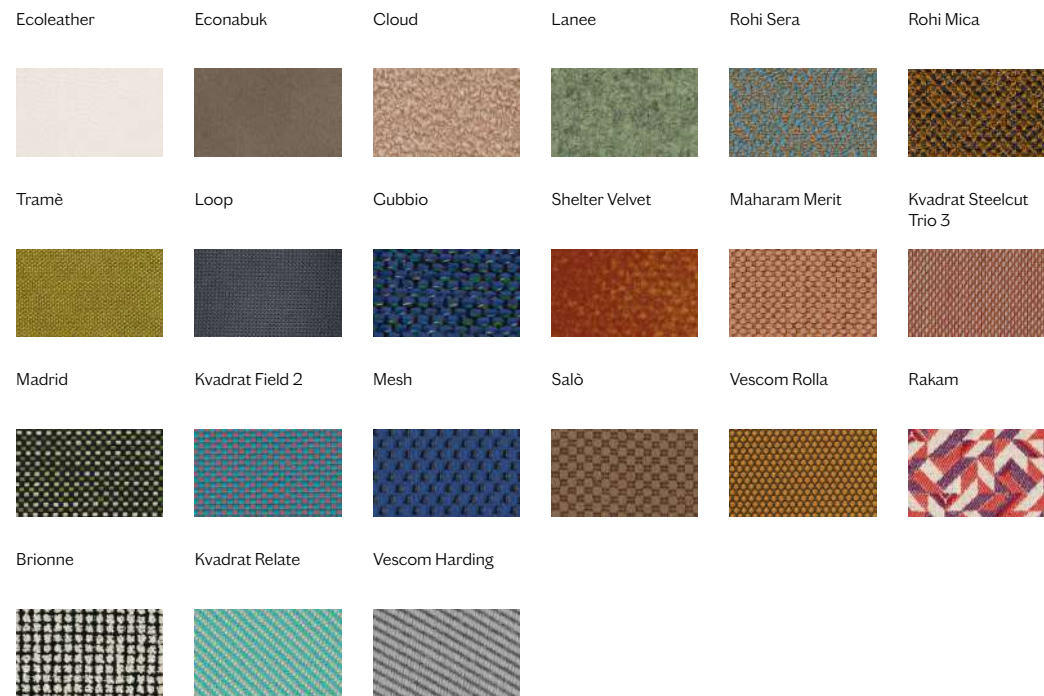

PELÈ

Design e-ggs

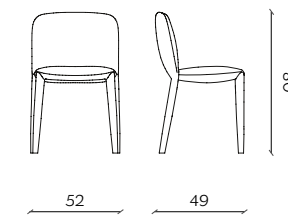

Tessuto Fabric

— Tonalità nel Campionario
Shades on Campionario



Custom COM:
h1,40x1,4 lm

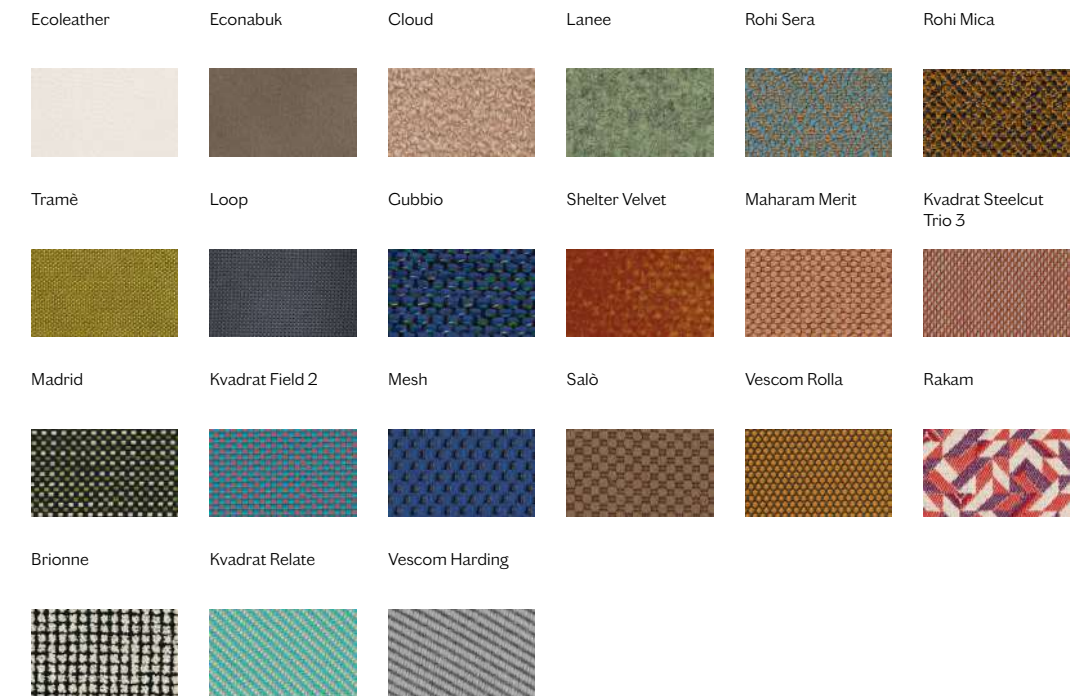

VITOS

Design Paolo Cappello

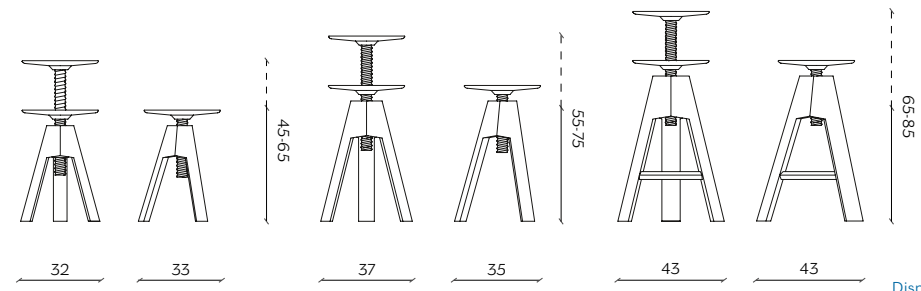

Disponibile in 3 misure:
basso, medio, alto
/Available in 3 sizes:
low, medium, high

Seduta
Seat

Faggio
Beech



Struttura
Structure

Laccato (12 colori)
Lacquered (12 tones)



FERROVITOS

Design Paolo Cappello

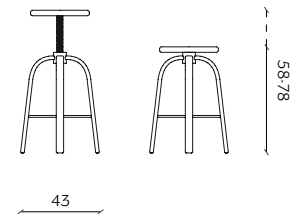

Seduta
Seat

Faggio
Beech



Faggio Nero
Black Beech



Struttura
Structure

Laccato (12 colori)
Lacquered (12 tones)



MILK

Design Paolo Cappello

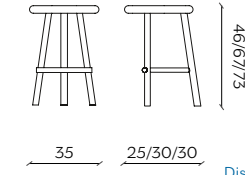

Disponibile in 3 misure:
basso, medio, alto
/Available in 3 sizes:
low, medium, high

Seduta
Seat

Faggio
Beech



Struttura
Structure

Laccato (12 colori)
Lacquered (12 tones)



Zincato
Zinc-coated



PEZZO

Design Stephanie Jasny

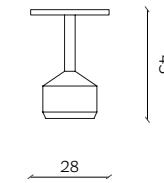

Struttura
Structure

Rovere Fiammato
Flamed Oak



Rovere Tinto Noce
Oak Stained Walnut



COLONY

Design Skrivio

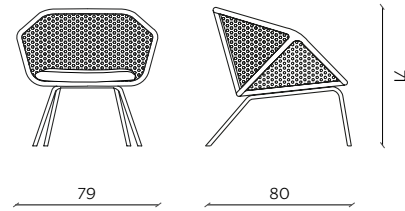

Struttura Structure



Paglia di Vienna Nera solo con cornice Faggio Nero /Black Vienna Straw only with Black Beech Frame

Custom COM:
h1,40x0,8 Im



Cambe Legs

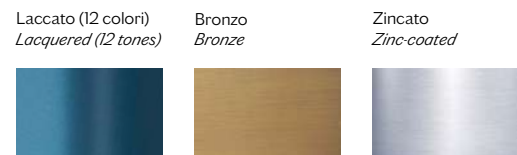

Cuscini Cushions

— Tonalità nel Campionario
Shades on Campionario



Custom COM:
h1,40x0,8 Im each kit

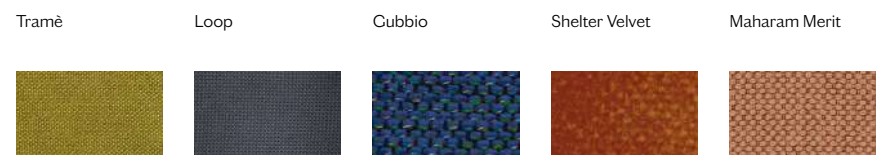

SERCIA

Design Francesco Beghetto

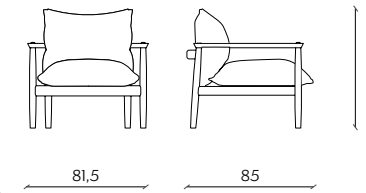

Struttura Structure



Cuscini Cushions

— Tonalità nel Campionario
Shades on Campionario

Custom COM:
h1,40x2,7 Im

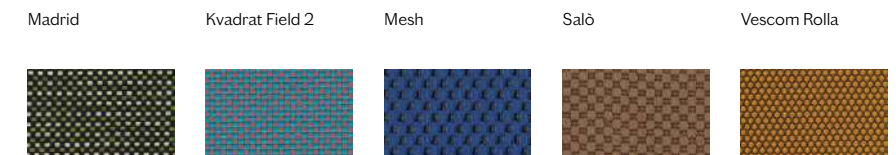
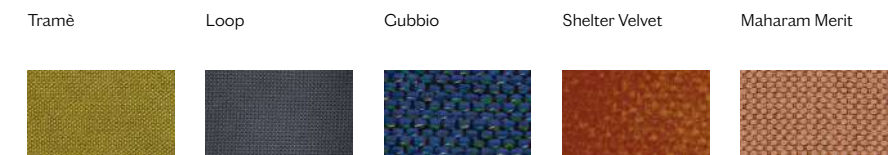
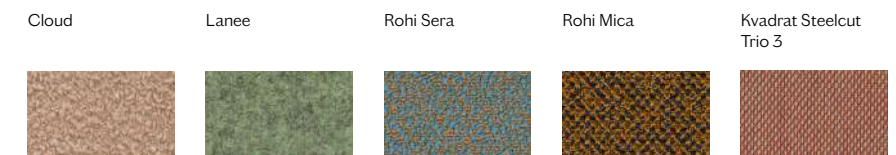

BOTERA FAMILY

Design e-ggs

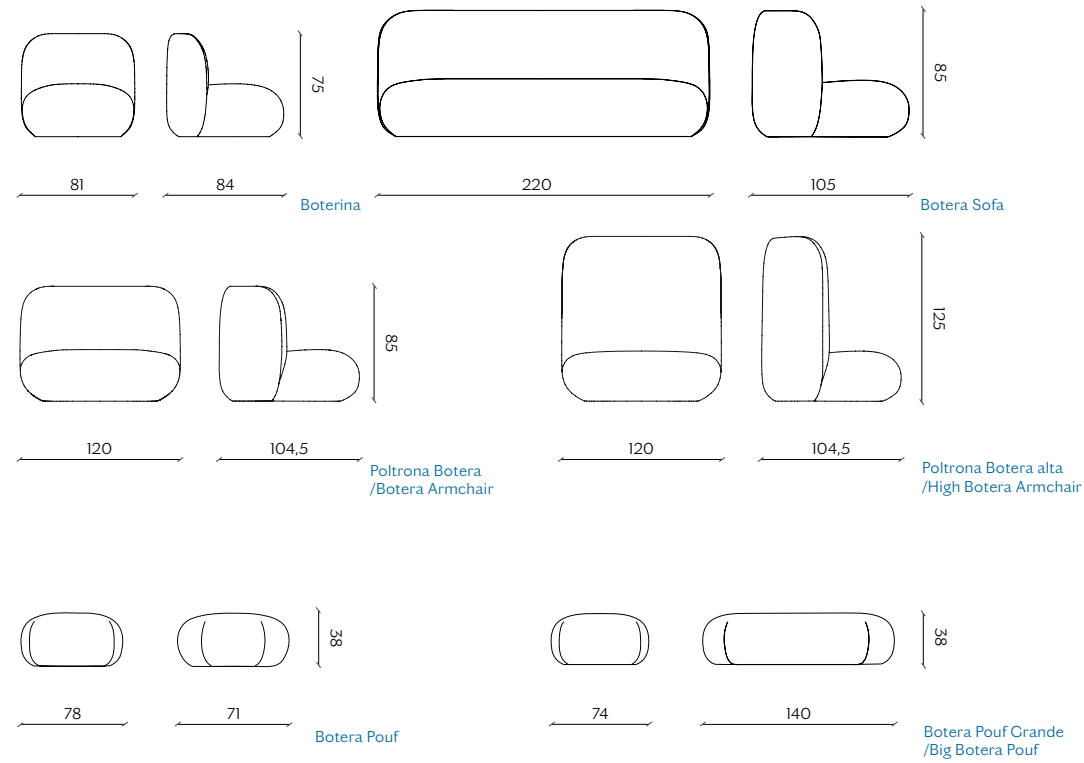

Tessuto
Fabric

— Tonalità nel Campionario
Shades on Campionario



Custom COM:
h1,40x5,5 lm Boterina
h1,40x10 lm Sofa
h1,40x5 lm Botera
h1,40x5,6 lm Botera high
h1,40x3 lm Pouf
h1,40x4,5 lm Pouf Large

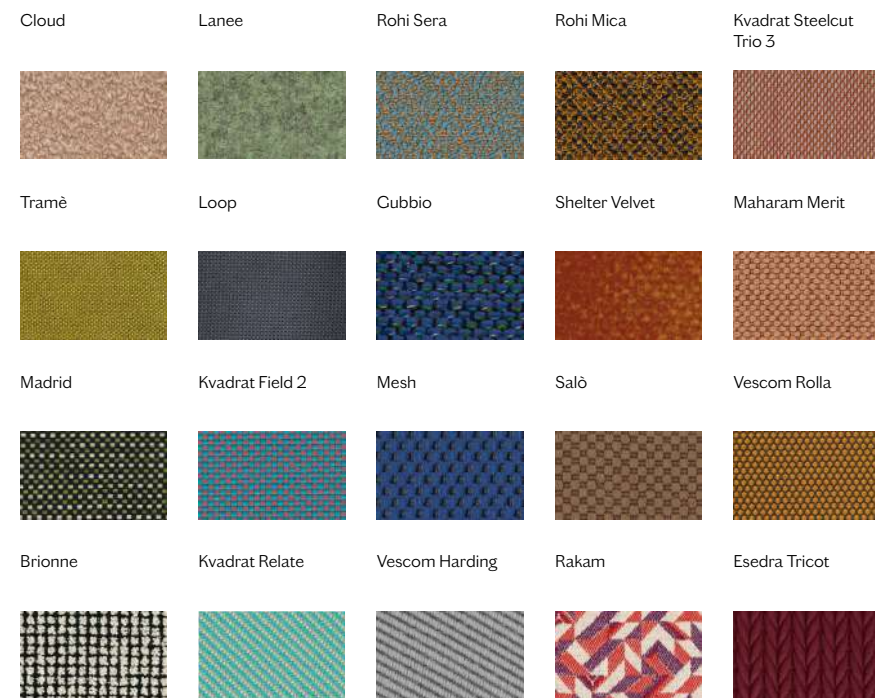

LEM

Design Francesco Beghetto

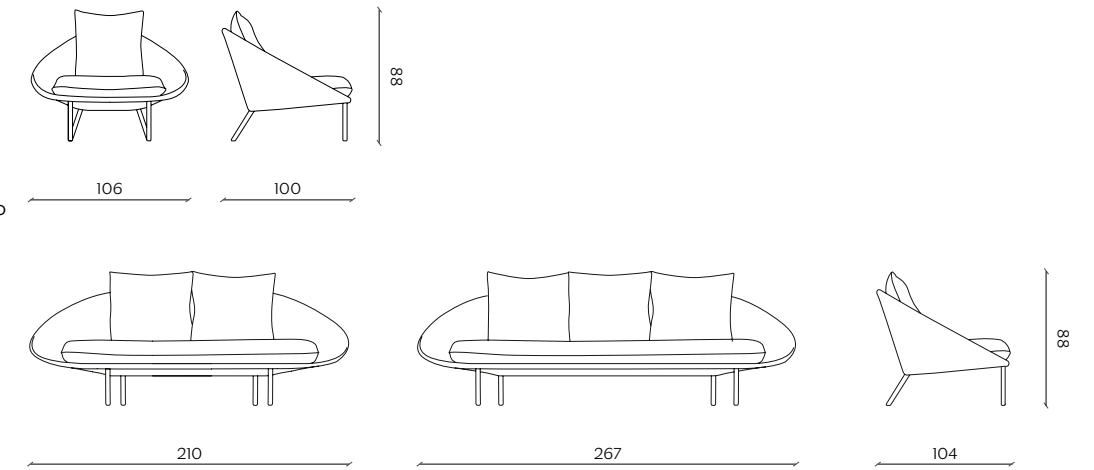

Struttura e cuscini
Structure and cushions

— Tonalità nel Campionario
Shades on Campionario



Custom COM:
h1,40x4,5 lm single
h1,40x8,8 lm 2 seats
h1,40x12,9 lm 3 seats

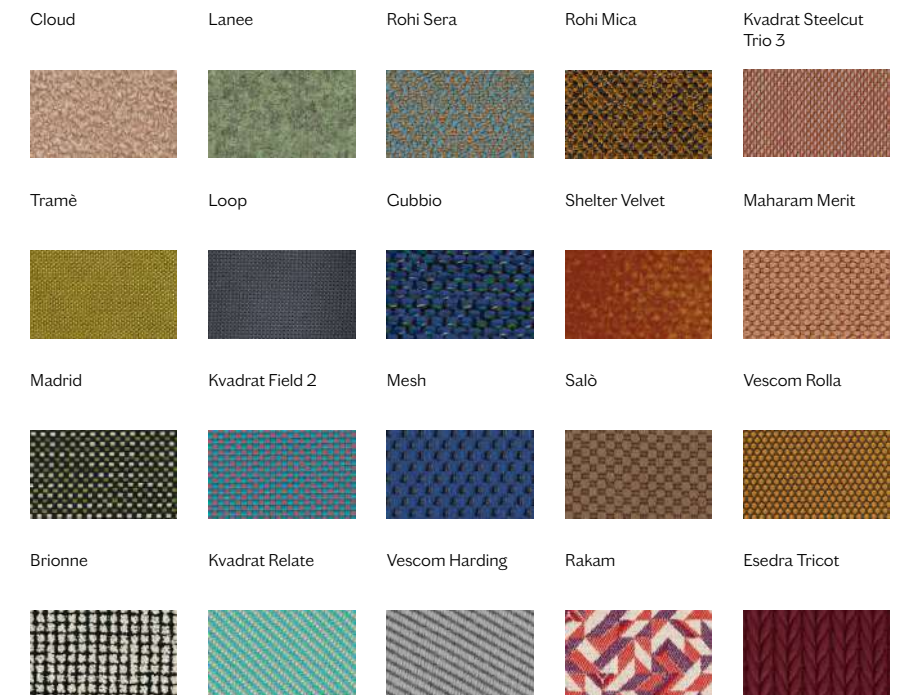

LOUISE

Design Miniforms Lab

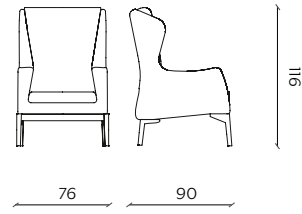

Struttura Structure



Cuscini Cushions

— Tonalità nel Campionario
Shades on Campionario

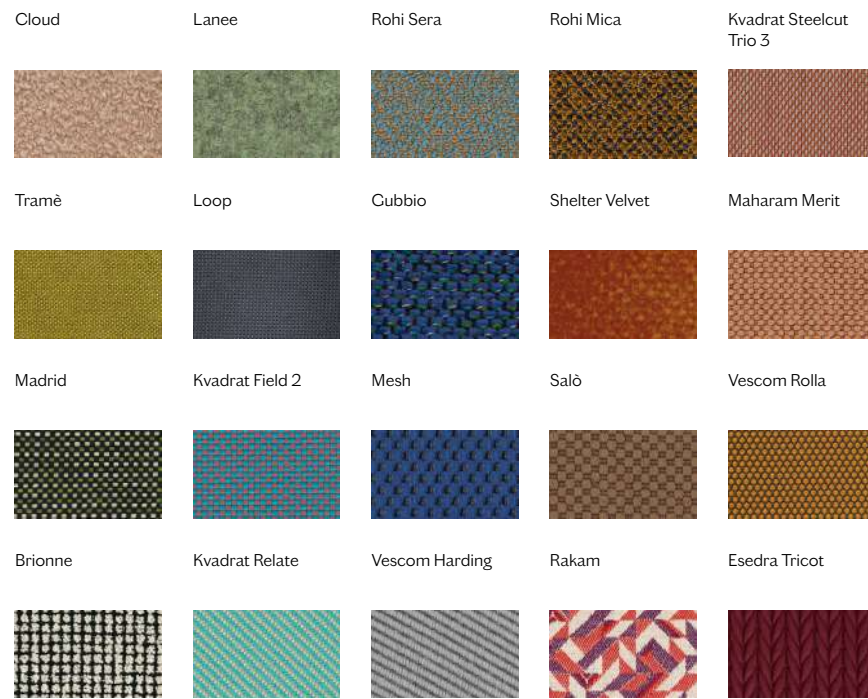

Custom COM:
h1,40x5 lm

DIPLOPIA

Design Skrivo

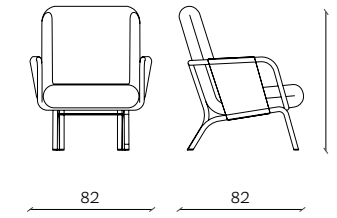

Struttura Structure



Cuscini Cushions

— Tonalità nel Campionario
Shades on Campionario

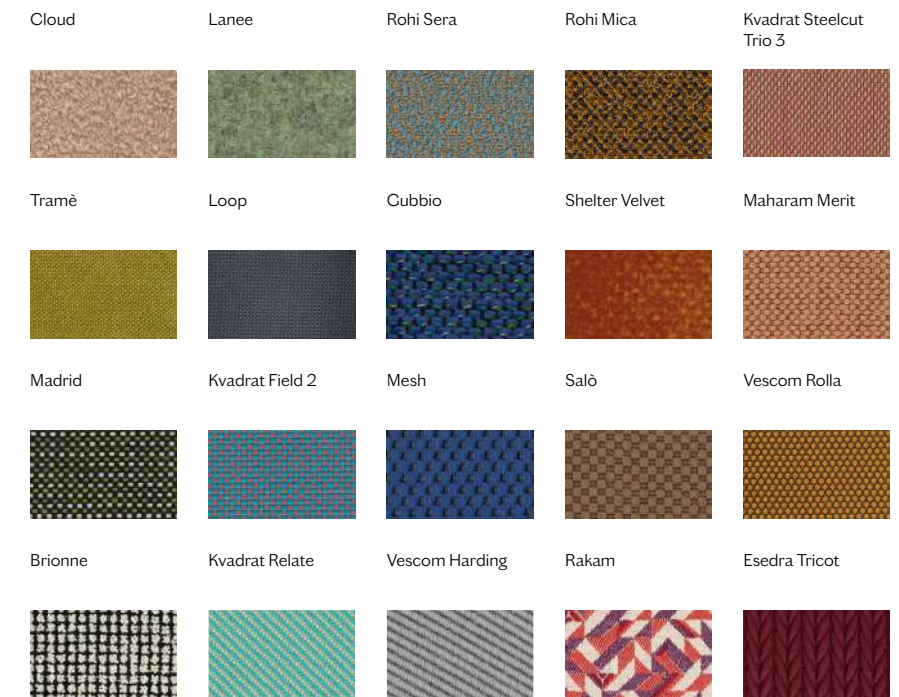

Custom COM:
h1,40x5 lm

FUROSHIKI

Design e-ggs

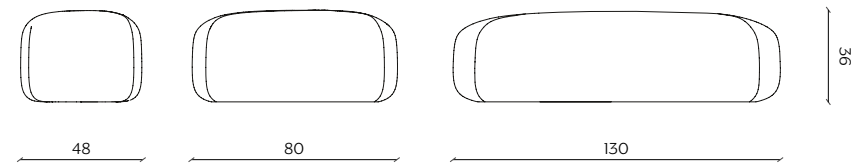

Tessuto Fabric

— Tonalità nel Campionario
Shades on Campionario

Custom COM:
h1,40x2,2 lm Small
h1,40x3,6 lm Medium
h1,40x4,8 lm Large

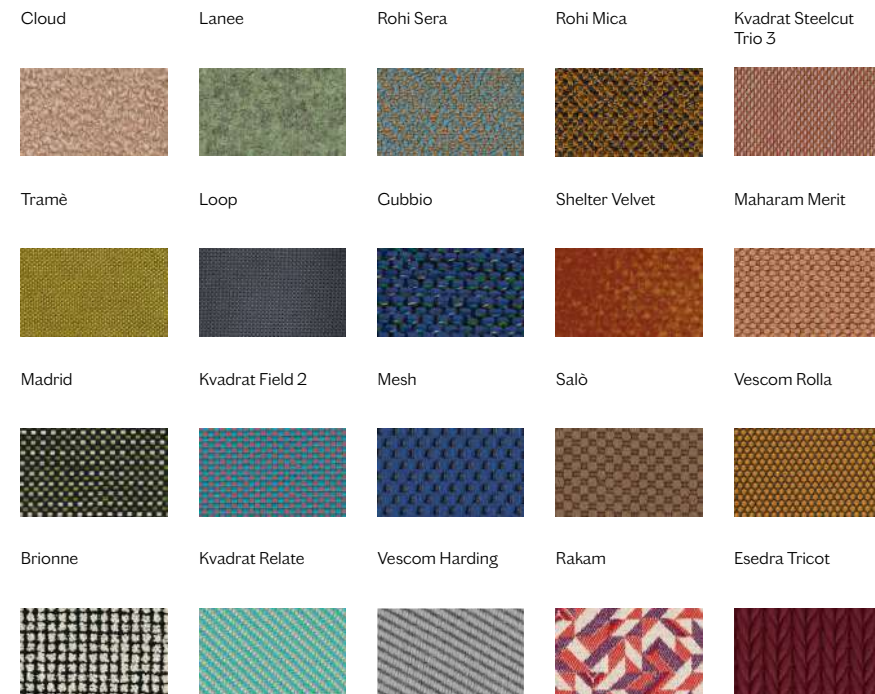

SHIKO

Design e-ggs

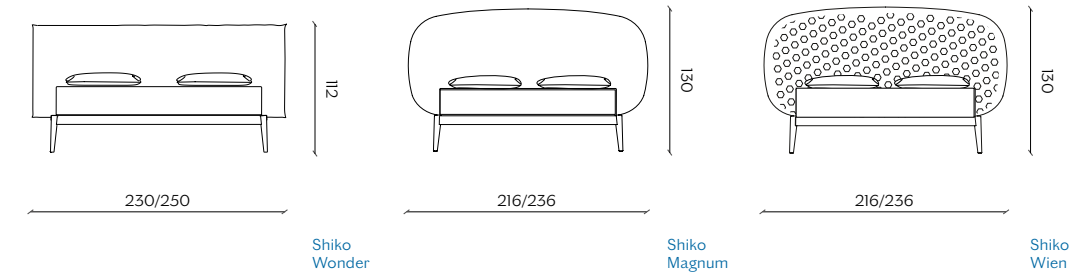

Struttura Structure

Cornice Shiko Wien
Frame Shiko Wien

Cuscini Cushions

— Tonalità nel Campionario
Shades on Campionario

Custom COM:
h1,40x7 lm

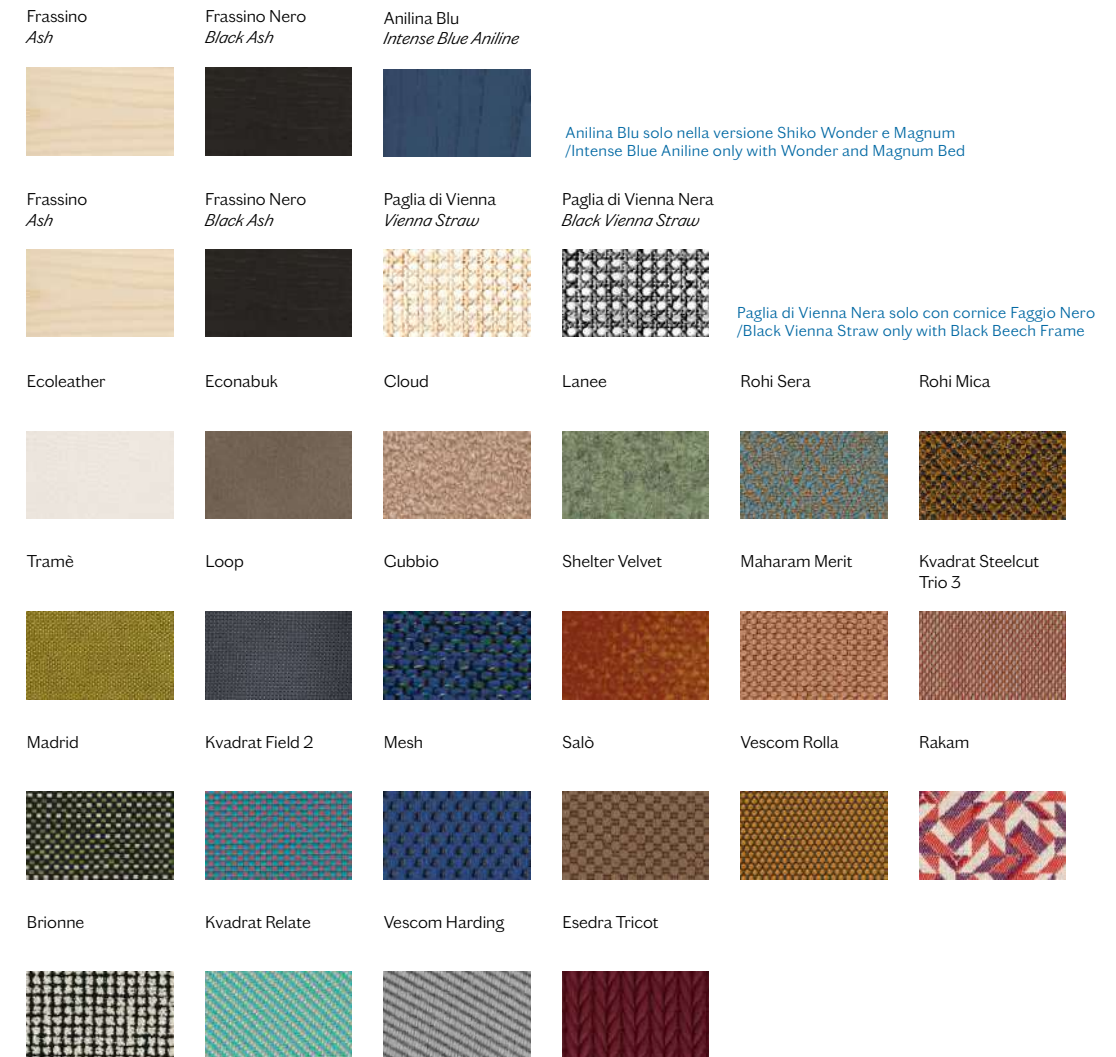

OZZ FAMILY

Design Paolo Cappello
con Simone Sabatti

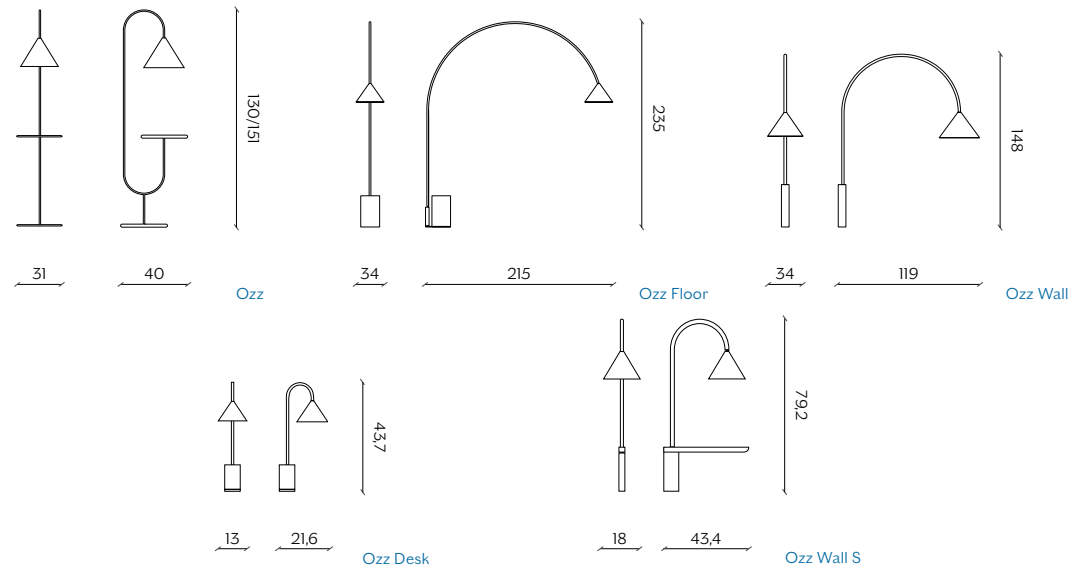

Struttura
Structure

Laccato Nero
Black Lacquered



Basamento
Base

Calcestruzzo
Concrete



Mensola
Shelf

Frassino
Ash



Frassino Nero
Black Ash



ECLIPSE

Design e-ggs

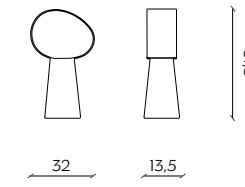

Struttura
Structure

Ceramica (11 colori)
Ceramic (11 tones)



DENT

Design Skrivo

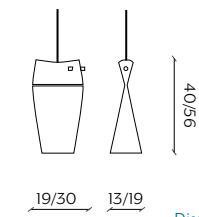

Disponibile in 2 dimensioni
/Available in 2 sizes

Struttura
Structure

Ceramica (11 colori)
Ceramic (11 tones)



KIKI

Design Paolo Cappello

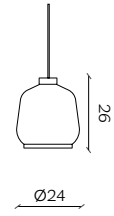

Struttura
Structure

Ceramica (11 colori)
Ceramic (11 tones)



TORA

Design Paolo Cappello

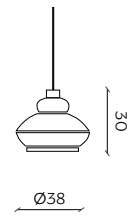

Struttura
Structure

Ceramica (11 colori)
Ceramic (11 tones)



SLOPE

Design Skrivo

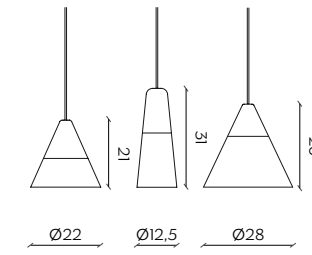

Struttura
Structure

Faggio
Beech



Anilina Nera
Black Aniline



Paralume
Shade

Bianco
White

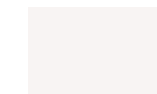

Albicocca
Apricot



Rame
Copper



Bronzo
Bronze



Grigio Seta
Silk Grey



COQUE

Design Alain Gilles

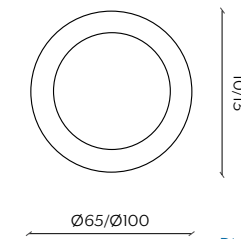

Struttura (Ceramica)
Structure (Ceramic)

Crema
Cream



Terracotta



Peltro



Finitura interna smaltata e finitura esterna opaca, nella stessa tonalità
/Inner glazed finish and outer matt finish, in the same tones

CICALES

Design Paolo Cappello

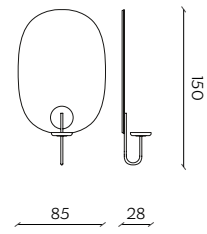

Struttura Structure

Rame
Copper



Laccato Nero
Black Lacquered



Mensola Shelve

Frassino
Ash



Frassino Nero
Black Ash



LES BROTHERS

Design Paolo Cappello

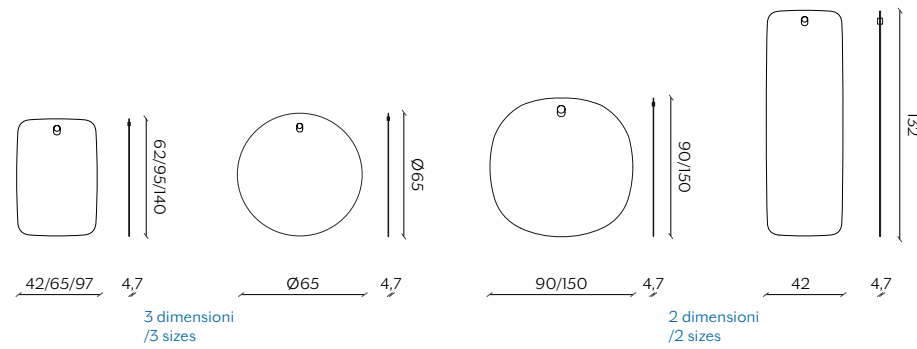

Dettaglio Detail

Faggio
Beech



BENVENUTO

Design Paolo Cappello

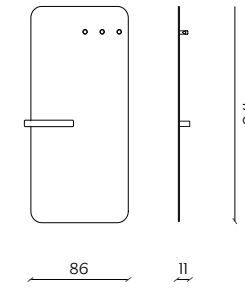

Contenitore e pioli Box and rods

Laccato (12 colori)
Lacquered (12 tones)



CICALES

Design Paolo Cappello

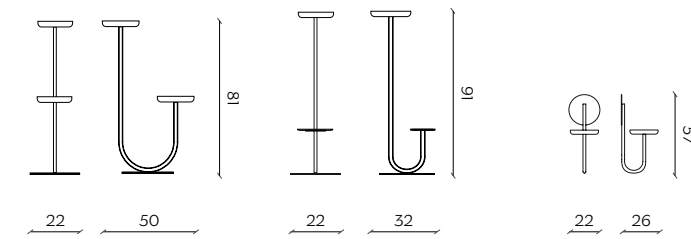

Struttura Structure

Rame
Copper



Laccato Nero
Black Lacquered



Mensole Shelves

Frassino
Ash



Frassino Nero
Black Ash



COLONY SCREEN

Design Skrivo

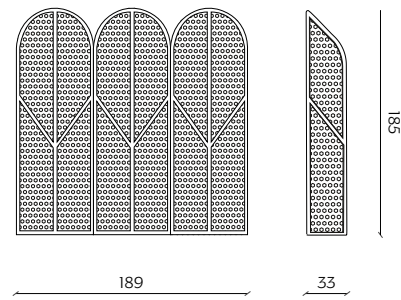

Struttura
Structure

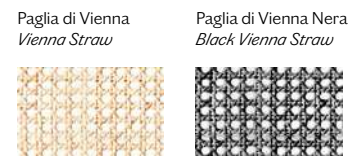
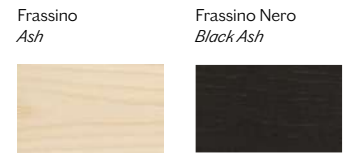

Paglia di Vienna Nera solo con cornice Frassino Nero
/Black Vienna Straw only with Black Ash Frame

GAME OF TRUST

Design Yiannis Chikas

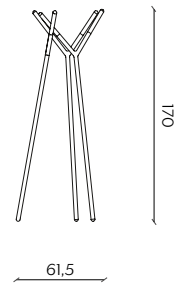

Struttura
Structure

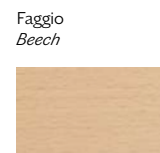

Dettaglio
Detail



BUBBLE

Design Yiannis Chikas

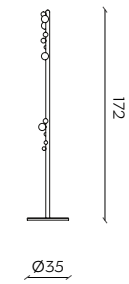

Struttura
Structure



Sfere
Spheres

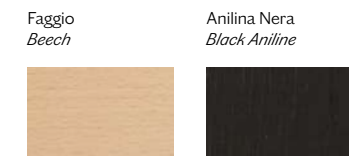

CAIO

Design Paolo Cappello

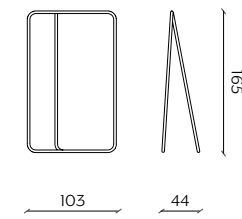

Struttura
Structure



CHIDO

Design Zaven

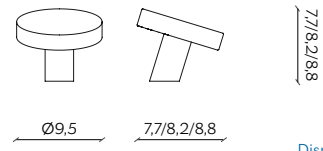

Disponibile in 3 inclinazioni
/Available in 3 angles

Struttura Structure

Anilina Bianca
White Aniline



Faggio
Beech



Anilina Grigia
Grey Aniline



Anilina Blu
Blue Aniline



Anilina Nera
Black Aniline



ART DIRECTION & GRAPHIC DESIGN

Miniforms Creative Lab

PHOTO

Alessandro Di Bon

INTERIOR STYLING

Greta Cevenini projects by 8-10, 28-32, 35, 42-46, 54, 58, 65-66, 82-84, 88-89, 98-100, 126-127, 144-148, 168-172, 199-202, 208-212
Laura Pozzi projects by 12-26, 34, 36-41, 48-52, 55-57, 60-64, 68-79, 86, 90-95, 102-125, 128-140, 149-166, 174-198, 204-206

COLOR REPRODUCTION

CM Studio 1

PRINT

Crafiche Antiga

SKETCHES

Piero Bardini

THANKS TO

Adelaide Cioni	Karpeta
Akqa Venice	Kn Industrie
Alberto Fiocco	Le Morandine
Angelo Ramonda	Locatelli Pepato
Ank Studio	Los Objectos Decorativos
Artemide	Louis De Belle
Besana Moquette	Lumina
Bottega Intreccio	Madlen Ceramics
Cara \ Davide	Matteo Zorzenoni
Carpet Edition	Mide Architetti
Cc tapis	MMAiro
Ceramicah	Nodus Rug
Ceramiche Rometti	Once Milano
Clinicaurbana	P420 Gallery
CuoreCarpenito	Paola C
Dadu Shin	Pasticceria Fondente
Danese Milano	Placée
Derek Wilson	Premiata Ceramica
Des Plans	Pulpo
DWA Design Studio	Roberto Aponte
Fornice Objects	Rogell Coll
Frette	Rosenthal
Gianni Tiveron	Sambonet
Guido De Zan	Sara Scalzotto
H-Farm	Scandola Marmi
Hà Porcelain	Stilnovo
Helle Mardahl	Vic Wright
Ichendorf Milano	Zanon Architetti Associati
Ilaria Bortolussi	

** ITINERARI **