

Sofas
Armchairs

SOFT



SOFT

Sofas, Armchairs
Poufs and Benches

SOFT

LEIVA



INDEX

Sofas — 6

Niveaux — 8
Glee — 24
Groovy — 38
Venise — 50
Aberdeen — 68
Cloud — 76
Jermyn — 90
Mustique — 100
Neil — 110
Snap — 116
Yard — 128
Lennox — 140
Kaiwa — 144
Taiki — 148
Yaki — 152

Armchairs — 156

Maddix — 158
Claire — 162
Lucylle — 164
Tarsia — 168
Alton — 172
Bice — 180
Eydo — 184
Fantino — 186
Felix — 188
Lady Jane — 190
Lennox — 194
Popsi — 198
Taiki — 200
Yard Daybed — 204

Poufs and Benches — 208

Aley — 210
Notch — 214
Pouf — 216
Tod — 218
Uma — 220
Fence — 226

Technical Index — 230

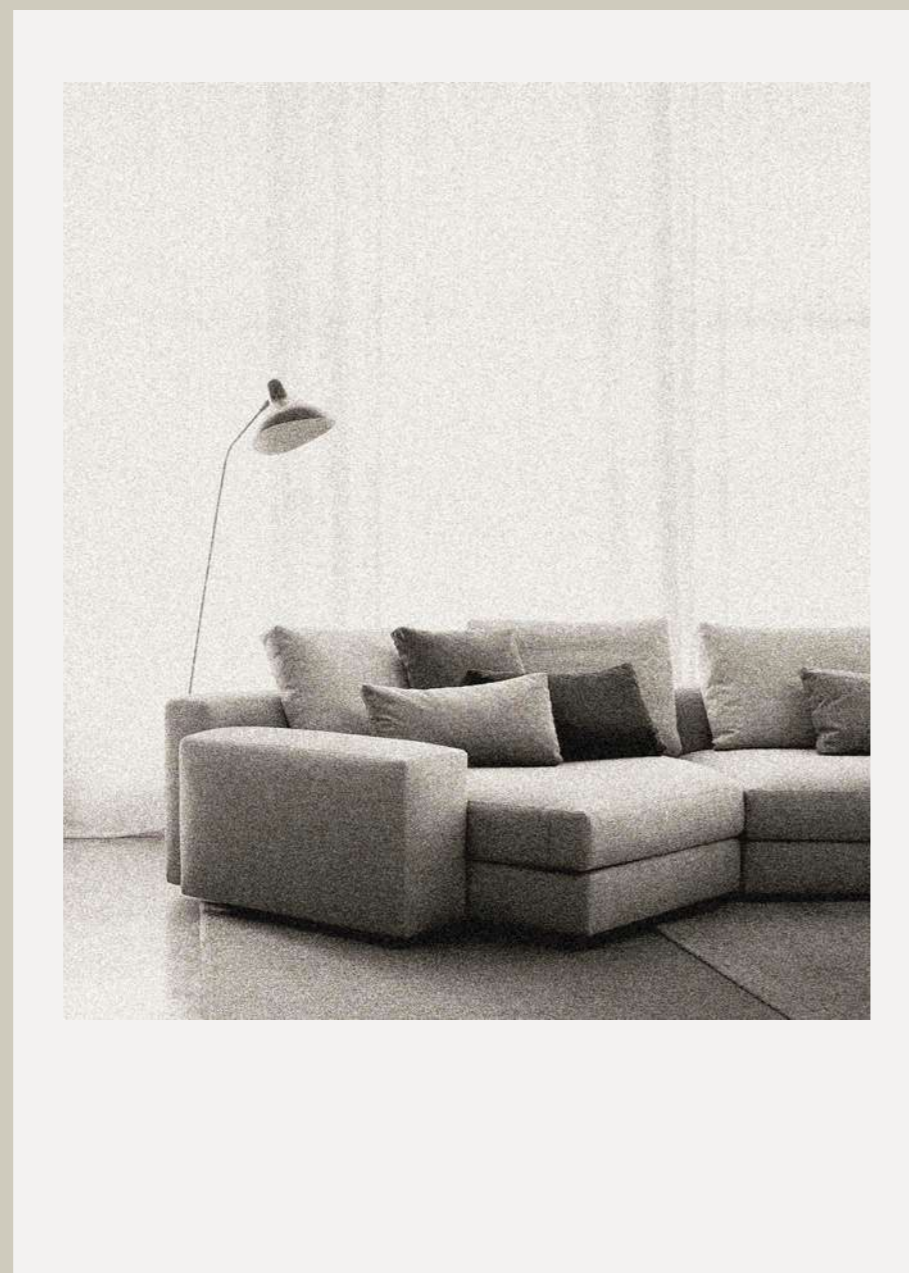

SOFAS

Eleganza discreta e spirito decontractée definiscono i divani Lema, perfetti interpreti di una filosofia progettuale che trova nel comfort e nella modularità i suoi caratteri peculiari. Divani diversi tra loro, ma sempre accomunati dall'alta qualità e dalla profonda attenzione al dettaglio. Una collezione in continuo sviluppo con proposte pensate per inserirsi in ogni ambiente dove accoglienza e convivialità, relax e calore ne sono le parole chiave.

Discreet elegance and decontractée spirit define the Lema sofas, perfect interpreters of a design philosophy that finds its peculiar characteristics in comfort and modularity. Sofas different from each other but always united by the high quality and by the deep care to detail. A collection in continuous development with proposals designed to fit into any room where hospitality and conviviality, relax and warmth are the keywords.



Niveaux

Dal più contemporaneo al più classico, Niveaux crea infinite possibilità grazie ai diversi moduli di seduta imbottiti quadrati, rettangolari e asimmetrici. Con schienali liberi o fissi, le molteplici facce di Niveaux esprimono la personalità giovane e fresca del divano.

From the most modern to the most classic, Niveaux creates infinite possibilities, thanks to the different square, rectangular and asymmetrical upholstered seating modules. With moveable or fixed back-rests, the multiple styles of Niveaux express the youthful and fresh personality of the sofa.

Design:
Federica Biasi





Divano, Sofa **Niveaux**
Poltroncina, Armchair **Claire**
Tavolino, Coffee Table **Francis**

Madia, Sideboard **Conchiglia**
Panca, Bench **Uma**
Pouf **Pouf**



Le composizioni modulari di sedute Niveaux sono disponibili con tavolini d'appoggio e abbinata a una serie di schienali e cuscini. Le proposte includono diverse combinazioni di tessuti e texture ton sur ton.



Niveaux modular seating compositions are available with coffee tables and combined with a series of backrests and cushions. The proposals include different combinations of fabrics and ton-sur-ton textures.



Divano, Sofa Niveaux



Divano, Sofa **Niveaux**
Tavolino, Coffee Table **Dolmen**

Storage System **LT40**

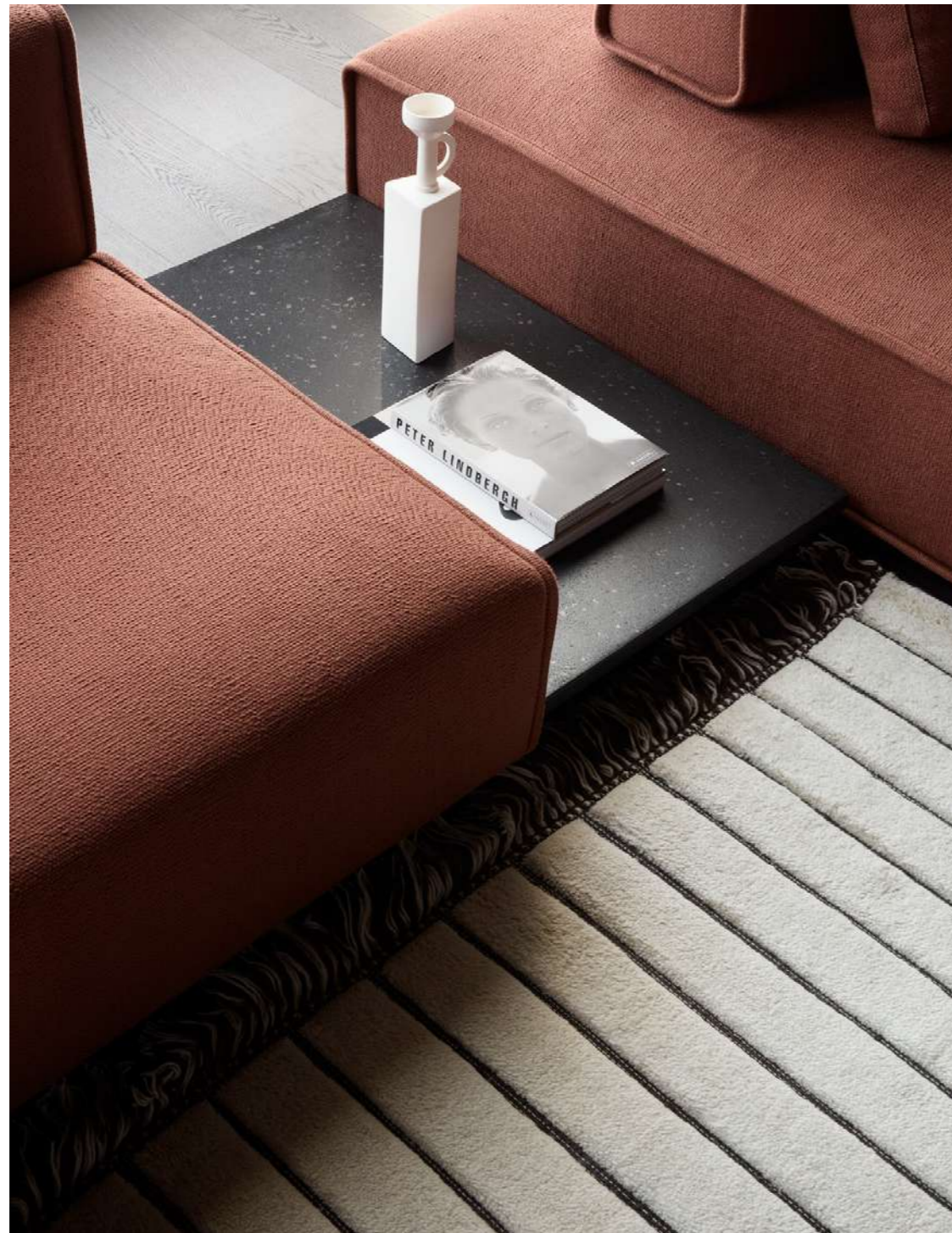

Una seduta versatile per la zona living, con distinte cuciture che ne esaltano il design. Niveaux è un divano che crea uno spazio confortevole ed essenziale, dove condividere momenti di puro relax.

A versatile seat for the living area, with distinctive stitching that enhances its design. Niveaux is a sofa that creates a comfortable and essential space, where you can share moments of pure relaxation.

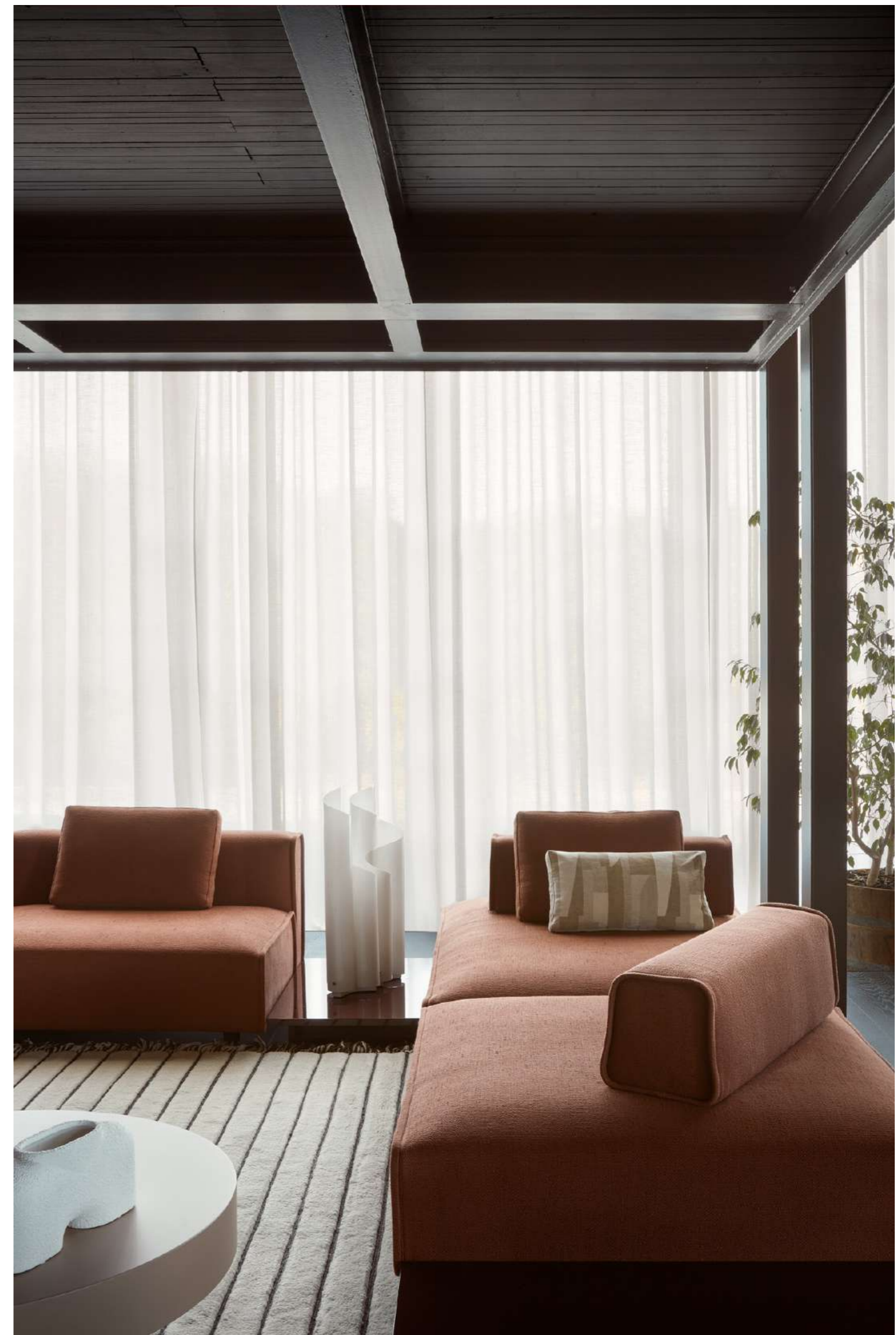

Un momento di relax e condivisione, molteplici combinazioni per dare vita ad un comfort personalizzato in ogni dettaglio. Niveaux diventa il protagonista della zona living, inserendosi con disinvoltura in ambienti contemporanei così come in spazi dall'atmosfera classica e tradizionale.

A moment of relaxation and conviviality, multiple combinations able to create a personalized comfort in every detail. Niveaux becomes the protagonist of the living area able to fit into contemporary environments as well as spaces with a classic and traditional atmosphere.



Divano, Sofa Niveaux
Storage System LT40

Un profilo minimale,
un calibrato equilibrio
di incastri in grado di dare
vita a paesaggi domestici
inediti. Con Niveaux,
la bellezza diventa una
questione di forme, il risultato
dell'attenzione al dettaglio
e alla sartorialità che con-
traddistingue la produzione
Lema.

A minimal profile, a smart
interlocking game capable
of giving life to unpreceden-
ted domestic landscapes.
With Niveaux, beauty becomes
a matter of shapes, the result
of the attention to detail
and tailoring that distinguishes
Lema products.





Glee

Design:
Officinadesign Lema

Le linee essenziali e i volumi morbidi caratterizzano le infinite possibilità di personalizzazione del divano modulare Glee. Grazie al suo spirito tradizionale, fa della versatilità il suo tratto distintivo, adattandosi pienamente alle diverse esigenze funzionali, di spazio ed estetiche.

The essential lines and soft volumes characterize the infinite possibilities of customization of the Glee modular sofa. Thanks to its traditional spirit, it makes versatility its distinctive feature, fully adapting to the different functional, space and aesthetic needs.





Divano, Sofa **Glee**
Tavolino, Coffee Table **Dolmen**

Storage System **LT40**
Tavolino, Coffee Table **Francis**



Glee appare al centro della zona giorno, distinguendosi per l'aspetto soffice ed accogliente. I tavolini frontali Dolmen, rotondo e quadrato, insieme ai monolitici tavolini Francis laterali, simboleggiano l'eterna attualità delle forme geometriche semplici nella forma, ma dal design senza tempo.

Glee appears in the center of the living area, distinguishing itself for its soft and welcoming appearance. The Dolmen front tables, round and square, together with the monolithic Francis side tables, symbolize the eternal actuality of geometric simple in shape, but with a timeless design.

Divano, Sofa **Glee**
Tavolino, Coffee Table **Dolmen**

Storage System **LT40**
Tavolino, Coffee Table **Francis**



L'attenta selezione di materiali, permette diverse combinazioni cromatiche e materiche dando vita a una proposta "su misura", emblema della ricerca costante di Lema.

The careful selection of materials allows for different colour combinations, giving life to this new "sartorial" proposal, emblem of Lema's constant research.





Divano, Sofa Glee
Storage System LT40

Comodità, ampiezza e comfort, ma anche armonia estetica. Glee è proposto con due profondità di seduta per accogliere diverse esigenze e momenti di relax. Divano ideale per potersi godere al massimo il tempo libero, da soli o in compagnia.

Relaxation, spaciousness and comfort, but also aesthetic harmony. Glee is proposed with two seat depths to accommodate different needs and moments of relaxation. Ideal sofa to enjoy your free time to the fullest, alone or in company.



Divano, Sofa Glee



Semplice ed essenziale nel design, ha cuciture e ribattiture evidenti, che segnano le sue forme sino a diventare decoro.



Simple and essential in design, it has evident seams and rivets, which mark its shapes until it becomes decoration.

Groovy

Il divano Groovy racchiude l'essenza del relax in una struttura esile e slanciata: un gioco di incastri tra forme rigide e morbide. Come petali che si schiudono, i suoi braccioli si aprono lievemente verso l'esterno portando in risalto la morbida cuscineria.

The Groovy sofa embodies the essence of relaxation in a slender structure: a game between rigid and soft shapes. A sofa that blooms with many petals, the armrests of Groovy open slightly outwards focusing on the soft cushions.

Design:
Officinadesign Lema





Divano, Sofa **Groovy**
Storage System **LT40** — **LT Frame**
Poltrona, Armchair **Alton**

Modular System **Selecta**
Tavolino, Coffee Table **Ortis**



Divano, Sofa **Groovy**
Tavolino, Coffee Table **Oydo**



L'equilibrio tra comfort e linearità, forme squadrate ed extra morbidezza, è il punto centrale attorno al quale Lema ha costruito il progetto del divano Groovy. Perfetto interprete di una filosofia improntata al relax, che trova nella modularità i suoi caratteri fondamentali.

The balance between comfort and linearity, square shapes and extra softness, is the central point around which Lema has built the whole project of the Groovy sofa. Perfect interpreter of a philosophy based on relaxation, where comfort and modularity are the fundamental characteristics.



Sostenuto da piedini non a vista, la scocca del divano Groovy è disponibile sia in pelle che in tessuto, così come la cuscineria, rendendo possibile un infinito gioco di combinazioni materiche e cromatiche.

Groovy is supported by non visible feet, the external rigid structure is in leather whilst the cushions can be covered in fabric or leather. The game of combinations passes from a material to a chromatic surface thanks to the possibility of combining elements of different colours, fabrics and textures.

Divano, Sofa **Groovy**
Poltrona, Armchair **Alton**

Tavolino, Coffee Table **Oydo**
Modular System **Selecta**



Cura dei dettagli e alta personalizzazione definiscono questo divano, manifestando la qualità made in Italy in ogni suo particolare.



Attention to detail and high customization define this sofa, manifesting the quality made in Italy in every detail.

Venise

Collezione di divani a terra fortemente caratterizzati sia dal punto di vista dell'espressione formale sia da quello dimensionale e spaziale, Venise si definisce nell'anima sistemica e nella sua elevata versatilità geometrica e compositiva.

Venise collection of floor standing sofas strongly characterized both from a formal and dimensional and spatial point of view, Venise defines itself in the systemic core and in its high geometric and compositional versatility.

Design:
Gabriele&Oscar Buratti





Divano, Sofa **Venise** Pouf **Pouf**
Tavolino, Coffee Table **Sign**



Elementi centrali, angolari, terminali a trapezio, curvilinei, a goccia, strutturano un sistema estremamente flessibile: dai divani lineari chiusi e modulari, con o senza braccioli a composizioni complesse che interrompono la linearità tipica degli imbottiti con tagli fortemente contemporanei.

Central, angular, trapezoid, curvilinear, drop shape, elements make an extremely flexible system: from linear sofas closed and modular, with or without armrests to complex compositions that interrupt the linearity typical of upholstered furniture with strongly contemporary cuts.

Divano, Sofa Venise
Tavolino, Coffee Table Oydo



Venise offre due profondità di seduta e due tipologie di bracciolo, uno alto stretto e uno basso largo. Caratteristiche tecniche a cui corrispondono modi diversi di vivere il divano, più o meno formale.

Venise offers two seat depths and two types of armrest, one high narrow and one low wide. Technical characteristics which correspond to different ways of living the sofa, more or less formal.





Divano, Sofa **Venise**
Tavolino, Coffee Table **Dolmen**

Dormeuse **Eydo**
Modular System **Selecta**



Venise accoglie tavolini accessori che ne arricchiscono l'utilità e la fruibilità tipica del vivere quotidiano. In continuità con le geometrie orizzontali del divano, il tavolino Venise è configurabile come elemento centrale o terminale con un doppio piano d'appoggio, con scaffali libreria laterali e vani contenitore per custodire gli oggetti del living.

Venise welcomes coffee tables accessories that enrich the usefulness and usability typical of everyday life. In continuity with the horizontal geometries of the sofa, the Venise coffee table can be configured as a central or terminal element with a double support surface, with side bookcase shelves and storage compartments to store living room objects.



Divano, Sofa Venice
Tavolino, Coffee Table Flowers



Caratteristica distintiva di Venise è la possibilità di abbinare liberamente i vari elementi, accostando tipologie di bracciolo e profondità uguali o diverse. Il divano assume così molteplici personalità, assecondando gli spazi che lo accolgono e il carattere di chi lo abiterà.

A distinctive feature of Venise is the possibility of freely combining the various elements, combining the same or different types of armrest and depth. The sofa so takes on multiple personalities, supporting the spaces that welcome it and the character of those who will inhabit it.



I singoli elementi di Venise sono pensati anche come pezzi unici: i terminali a goccia o a trapezio diventano particolari dormeuse capaci di enfatizzare con il loro forte carattere gli ambienti. L'originale elemento a goccia, utilizzato freestanding, diventa un accogliente rifugio per il relax grazie alle sue forme morbide e sinuose.

The individual elements of Venise are also thought of as one-of-a-kind: the drop shape or trapezium terminals become special daybeds capable of emphasizing the rooms with their strong character. The original drop-shaped element, used freestanding, becomes a cosy retreat for relaxation thanks to its soft and sinuous shapes.



Aberdeen

Design:
Officinadesign Lema

Aberdeen sceglie un look vissuto grazie alla housse che morbidamente lo avvolge. Il bracciolo a martello è sottolineato dalle pieghe del tessuto mentre i morbidi volumi della seduta hanno cuciture sartoriali a coda di topo. Il comfort è assicurato dall'imbottitura in poliuretano a cui si aggiunge una speciale fibra anallergica ecologica.

Aberdeen chooses an experienced look thanks to the housse that softly wraps it. The hammer armrest is underlined by the folds of the fabric while the soft volumes of the seat have tailored seams. Comfort is ensured by the polyurethane padding to which is added a special ecological hypoallergenic fiber.





Divano, Sofa **Aberdeen**
Tavolino, Coffee Table **Cruise**

Modular System, **Selecta**
Pouf **Pouf**



Estetica e funzione convivono in Aberdeen, divano dall'innata eleganza dove abbandonarsi al relax. Lo sviluppo tecnico non sovrasta l'estetica dal sapore classicheggiante che fa di Aberdeen un passepartout oltre le mode capace di abitare ogni spazio.

Aesthetics and function coexist in Aberdeen, a sofa with an innate elegance where you can indulge in relax. The technical development does not dominate the aesthetics with a classic flavour that makes Aberdeen a Passepartout beyond the fashions capable of living in any space.



Insieme al divano a due e tre posti, Aberdeen propone anche un avvolgente poltrona che riprende nelle forme gli stilemi stilistici e il look morbido e vissuto.

Together with the two and three-seater sofa, Aberdeen also offers an enveloping armchair that incorporates the stylistic features and the soft, experienced look.



Cloud

Design:
Francesco Rota



Giocose geometrie caratterizzano le infinite possibilità compositive di Cloud, divano modulare da disegnare usando undici moduli in più profondità e tre braccioli di dimensione, forma e altezza diverse: il modulo centrale può essere scelto come terminale oppure staccato da usare come pouf; lo schienale può funzionare anche come fianco o elemento separatore tra due sedute, il bracciolo può diventare piccola seduta o tavolino.

Playful geometries characterize the infinite compositional possibilities of Cloud, a modular sofa to be designed using eleven modules in more depth and three armrests of different size, shape and height: the central module can be chosen as a terminal or detached to be used as a pouf; the backrest can also function as a side or separating element between two seats, the armrest can become a small seat or table.

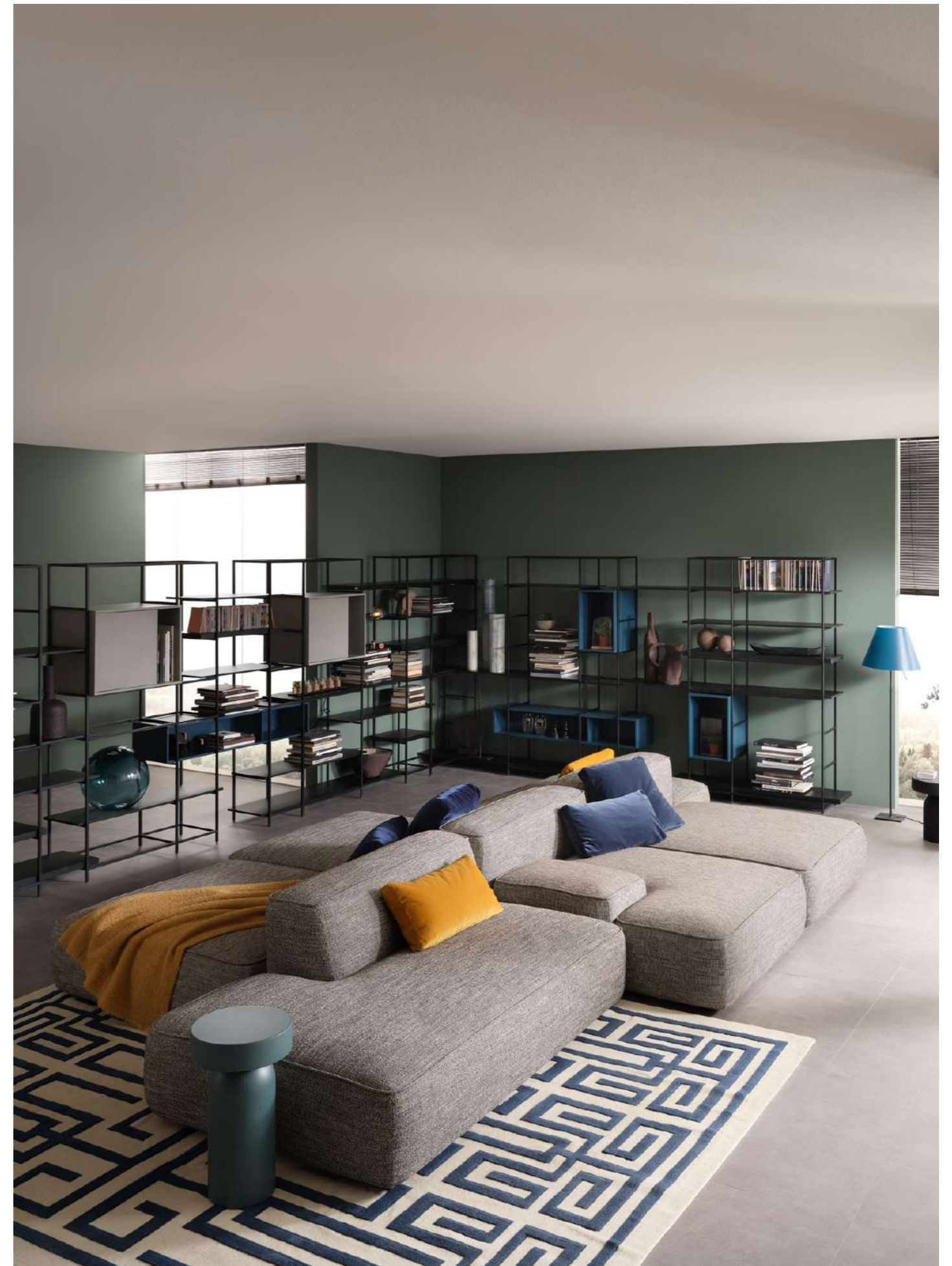



Divano, Sofa **Cloud**
Libreria, Bookcase **Plain**

Tavolino, Coffee Table **Francis**



Divano, Sofa **Cloud**
Libreria, Bookcase **Plain**

Tavolino, Coffee Table **Francis**
Pouf **Pouf**



Divano, Sofa **Cloud**
Tavolino, Coffee Table **Cruise**

Tavolino, Coffee Table **Sign**
Modular System **Selecta**



Cloud rappresenta una componibilità libera che declina i codici di modularità e personalizzazione di Lema in un divano da progettare su misura. Il gioco di combinazioni è anche cromatico e materico, grazie alla possibilità di accostare elementi di colori, tessuti e texture diversi.

Cloud represents a free modularity that declines the codes of modularity and customization of Lema in a sofa to be tailoring designed. The play of combinations is also chromatic and material, thanks to the possibility of combining elements of different colours, fabrics and textures.



Le linee curve e i volumi generosi fanno di Cloud una presenza perfetta in living e lounge di gusto contemporaneo.

Curved lines and generous volumes make Cloud a perfect presence in contemporary living and lounge areas.

Divano, Sofa **Cloud**
Poltrona, Armchair **Bice**

Tavolino, Coffee Table **Flowers**
Cassettiera, Chest of Drawers **Nine**



Jermyn

Divano modulare, anche angolare, Jermyn gioca sugli spessori contenuti di braccioli e schienali che si schiudono lievemente ad accogliere i morbidi cuscini di seduta. A conferire ulteriore leggerezza, i piedi a sezione piatta, in fusione di metallo, sostengono la struttura sollevandola da terra. L'identità senza tempo di Jermyn è enfatizzata dal profilo esterno di braccioli e schienale segnati da una cucitura sartoriale che ne sottolinea la curvatura della struttura.

Design:
Gordon Guillaumier



Modular sofa, also angular, Jermyn plays on the contained thicknesses of armrests and back seats that open slightly to accommodate the soft seat cushions. To give further lightness, the flat section feet, in cast metal, support the structure by lifting it from the ground. Jermyn's timeless identity is emphasized by the external profile of armrests and backrest marked by a tailoring seam that underlines the curvature of the structure.





Elegante versione in tessuto per Jermyn, che nel nome svela il carattere sartoriale. Il divano prende infatti il nome dall'omonima strada londinese sede di storiche sartorie, veri e propri laboratori del su misura con cui Lema condivide la vocazione alla personalizzazione.

Elegant fabric version for Jermyn sofa, which in the name reveals the sartorial character. The sofa takes its name from the homonymous street in London, home to historic tailors, real workshops of the tailor, which Lema shares the vocation to customization with.

Divano, Sofa Jermyn



Divano, Sofa Jermyn
Tavolino, Coffee Table Sign

Tavolino, Coffee Table Mr. Zheng

Ideale per abbandonarsi a momenti di autentico relax, da vivere da soli o in compagnia, Jermyn è un divano accogliente, caratterizzato da un confort quasi inatteso e da una seduta avvolgente, grazie ai particolari braccioli che si aprono come ali: un invito al massimo comfort.

Ideal to abandon yourself in moments of authentic relaxation, to live alone or in company, Jermyn is a cosy sofa, characterized by an almost unexpected comfort and an embracing seat, thanks to the special armrests that open like wings: an invitation to maximum comfort.





Il disegno ricercato e la fattura pregiata di Jermyn, insieme a perfetto esercizio di stile e omaggio alla cultura sartoriale, si esalta nella composizione angolare con sofisticato rivestimento in pelle.

The refined design and the fine workmanship of Jermyn, a perfect exercise of style and homage to tailoring culture, is enhanced by the angular composition with sophisticated leather coating.

Divano, Sofa **Jermyn**
Tavolino, Coffee Table **Sign**

Modular System **Selecta**

Mustique

Design:
Gordon Guillaumier



Mustique è l'idea di divano come materializzazione di un luogo leggero e accogliente dove rilassarsi. Isola morbida sospesa, quasi a galleggiare nell'ambiente come sottende lo stesso nome che riprende quello di una piccola isola dell'arcipelago delle Grenadine. Raffinato incontro formale di modernità e classicità per un divano modulare generoso nelle proporzioni dalla forte connotazione contemporanea.

Mustique is the idea of a sofa as the materialization of a light and welcoming place to relax. Soft suspended island, almost floating in the space as the name implies that of a small island in the Grenadine archipelago. Refined formal meeting of modernity and classicism for a generous modular sofa in proportions with a strong contemporary connotation.





Divano, Sofa **Mustique**
Tavolino, Coffee Table **Cruise**



Spazioso ed elegantemente informale, Mustique è definito dalla struttura in profilato metallico che sostiene la base imbottita sulla quale sono appoggiati i cuscini di seduta, un doppio strato morbido che conferisce forte linearità al disegno.

Spacious and elegantly informal, Mustique is defined by the metal profile structure that supports the padded base on which the seat cushions stay, a soft double layer that gives the design a strong linearity.

I cuscini di Mustique scelgono la forma regolare del parallelepipedo, declinata in una gradazione di dimensioni diverse a seconda della funzione con rivestimenti impreziositi dalla particolare cucitura pizzicata che sottolinea le forme.

The Mustique cushions choose the regular shape of the parallelepiped, declined in a gradation of different sizes depending on the function with upholstery embellished with the particular pinched seam that underlines the shapes.





Divano, Sofa **Mustique**
Tavolino, Coffee Table **Cruise**

Vetrina, Display Cabinet **Galerist**



Neil

Design:
Francesco Rota

Perfetta sintesi di un'idea di comfort su misura, il divano modulare Neil si distingue per la seduta morbida, le forme generose e le linee squadrate di schienale e braccioli leggermente inclinati verso l'esterno a sottolinearne la sensazione di accoglienza e comodità.

Perfect synthesis of an idea of tailored comfort, the Neil modular sofa stands out for its soft seat, generous shapes and square lines of backrest and armrests slightly inclined towards the outside to underline the feeling of welcome and comfort.



Neil si definisce nel doppio carattere, estetico e funzionale: la possibilità di scegliere due altezze di schienale e bracciolo ne caratterizza estetica e funzione d'uso. Più informale nella versione bassa, più formale scegliendo quella alta.

Neil is defined in the double character, aesthetic and functional: the possibility of choosing two heights of the back seat and armrest characterizes its aesthetics and function of use. More informal in the low version, more formal by choosing the high version.



Sia in versione fissa sia modulare, Neil svela nei dettagli la sua personalità sofisticata: dai piedini che rileggono i codici tipici degli anni '50, all'elegante cucitura sartoriale che corre lungo il perimetro della struttura e dei cuscini sottolineandone il disegno.

Both in the fixed and modular versions, Neil reveals its sophisticated personality in detail: from the feet that re-read the typical codes of the 1950s, to the elegant tailored seam that runs along the perimeter of the structure and cushions underlining its design.



Snap

Design:
Francesco Rota



Morbido nel comfort, essenziale nelle forme rigorose e nei suoi incastri geometrici, Snap è un divano a terra modulare dalla spiccata componibilità pensato per disegnare soluzioni fortemente personalizzate. Grazie all'ampia varietà dei moduli, in due profondità, si declina in divani lineari o angolari arricchiti da chaise longue, pouf, sedute, centrali e terminali anche asimmetrici.

Soft in comfort, essential in rigorous shapes and in its geometric joints, Snap is a modular floor standing sofa with a strong modularity designed to draw highly customized solutions. Thanks to the wide variety of modules, in two depths, it is available in linear or corner sofas enriched with chaise longues, poufs, seats, central and end units, also asymmetrical.





Divano, Sofa Snap
Tavolino, Coffee Table Cruise

Snap è un divano che si presta a composizioni originali e inaspettate. In una stessa composizione, si possono utilizzare elementi lineari ed elementi asimmetrici, a doppia profondità di seduta, per creare angoli raccolti e avvolgenti.

Snap is a sofa suitable for original and unexpected compositions. In the same composition, it is possible to use linear elements and asymmetrical elements, with double seat depth, to create gathered and embracing corners.

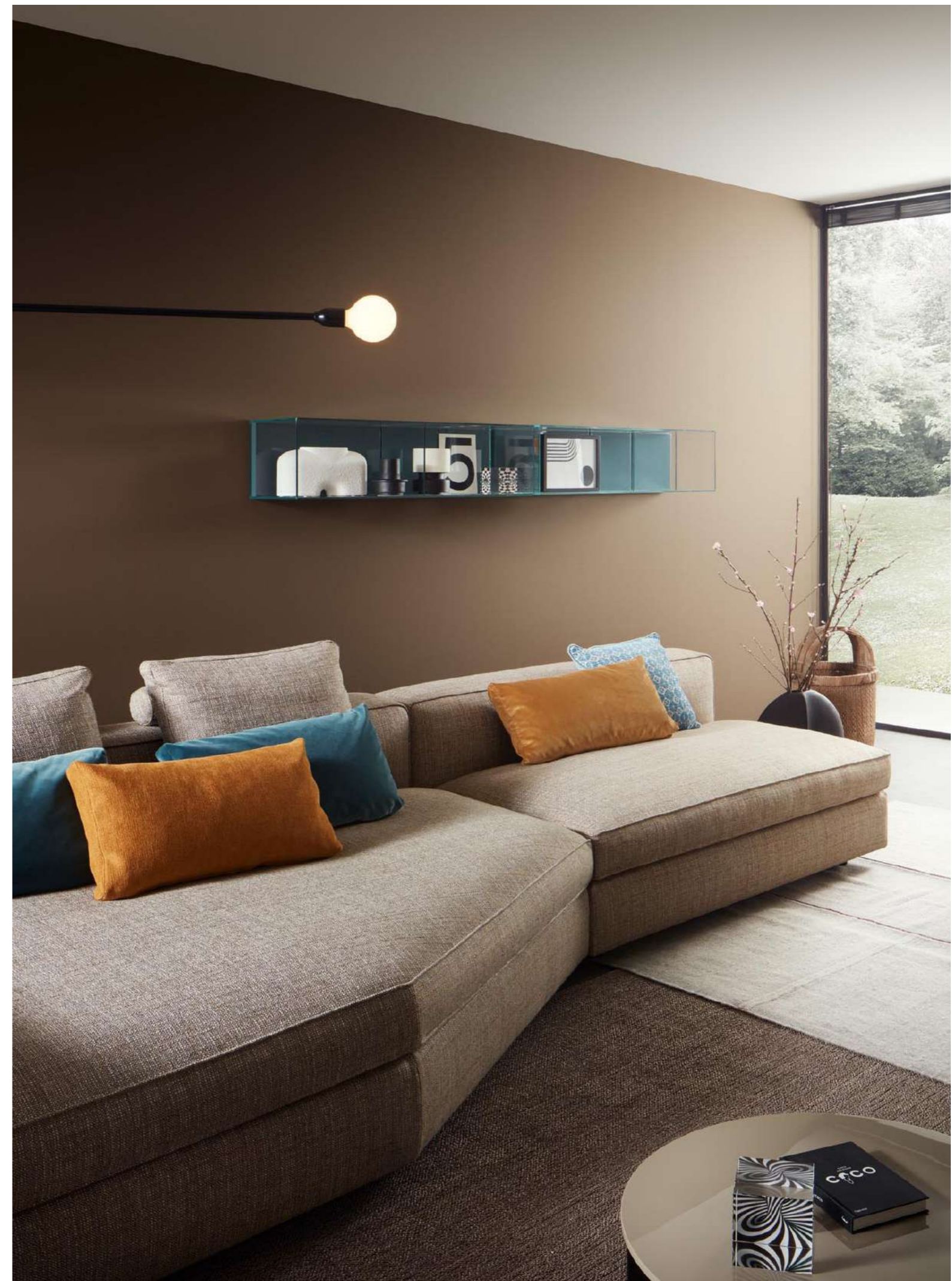



Divano, Sofa **Snap**
Storage System **LT40**

Tavolino, Coffee Table **Sign**



Snap ha le caratteristiche di un progetto dallo spirito puro dall'innata morbidezza. La sua identità è espressione di un vero e proprio sistema di cuscini votato al massimo relax.

Snap has the characteristics of a project with a pure spirit and innate softness. Its identity it is the expression of a real pillow system devoted to maximum relax.

Divano, Sofa **Snap**
Tavolino, Coffee Table **Mansion**



Divano, Sofa Snap
Tavolino, Coffee Table Cruise

Yard

Design:
Francesco Rota



Con Yard il divano diventa spazio multifunzione. Al comfort dei volumi imbottiti sono integrati piani di appoggio, mensole, contenitori a giorno per un sistema altamente personalizzabile. L'estetica è giocata sul sottile equilibrio fra la struttura a vista in metallo rivestita in tessuto, un piano sorretto da piedi giuntati attraverso agganci a sezione triangolare che crea l'appoggio per i morbidi cuscini e braccioli in un contrasto armonico che ne diventa peculiarità estetica.

With Yard the sofa becomes a multifunctional space. Supporting shelves, and open containers are integrated in the comfort of the padded volumes for a highly customizable system. The aesthetic is played on the thin balance between the exposed metal structure covered in fabric, a top supported by feet joined through triangular section hooks that creates the support for the soft cushions and armrests in a harmonious contrast that becomes an aesthetic peculiarity.

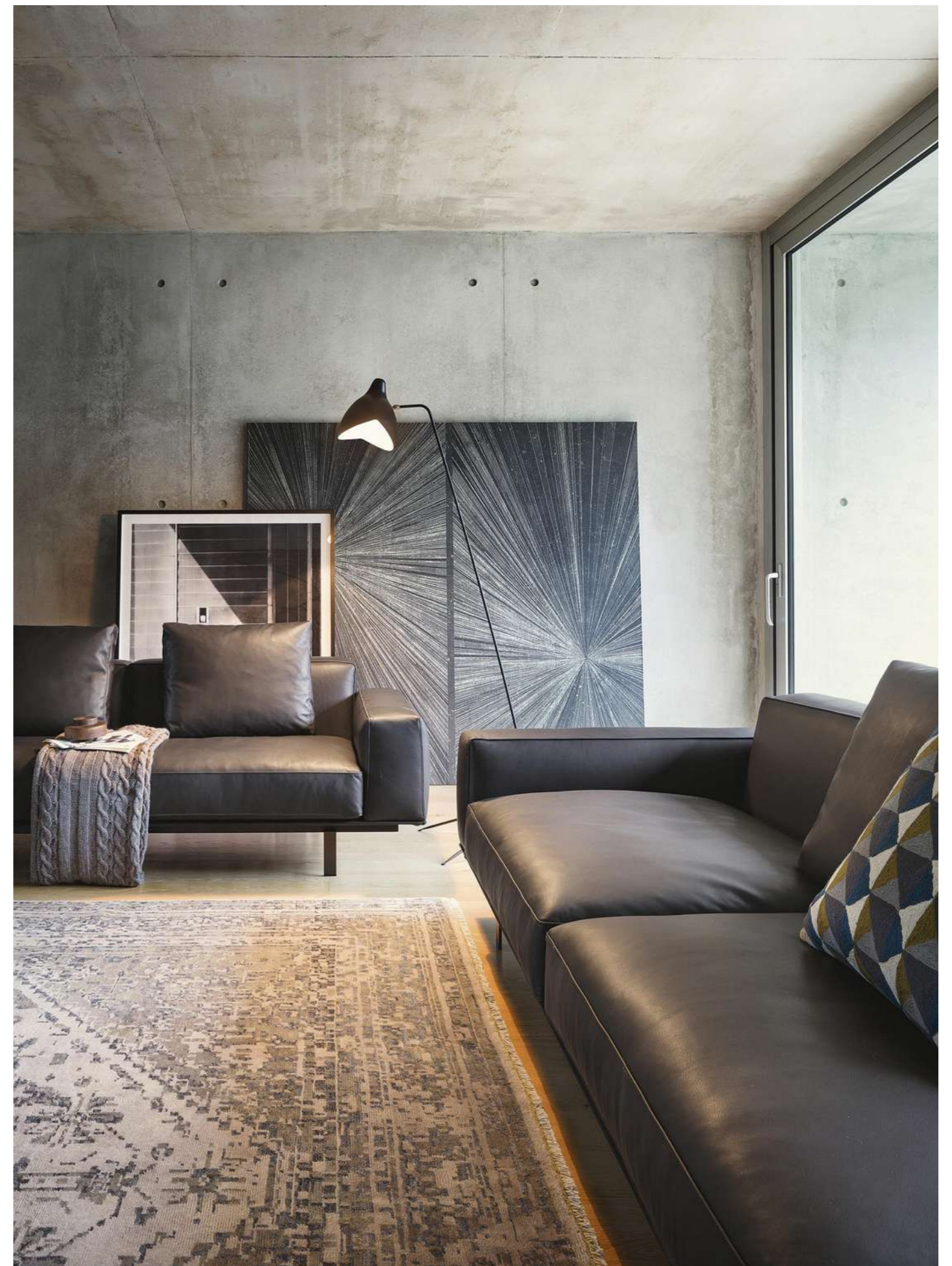



Divano, Sofa Yard



Divano, Sofa **Yard**
Poltrona, Armchair **Claire**

Tavolino, Coffee Table **Ortis**
Tavolino, Coffee Table **Francis**

Madia, Sideboard **Rainbow**





Divano sistemico, Yard coniuga la modularità dell'imbottito a quella dei sistemi contenitivi. La collezione che reinterpreta la creatività tipica del design industriale anni '60 nasce dalla volontà di trovare un punto di incontro con i sistemi modulari, parte integrante del DNA di Lema.

Systemic sofa, Yard combines the modularity of the upholstery with that of the storage systems. The collection that reinterprets the typical creativity of the 1960s industrial design was born from the desire to find a meeting point with modular systems, an integral part of Lema's DNA.

Divano, Sofa Yard
Tavolino, Coffee Table Sign



Due complementi che, accostati nell'incontro con la parte morbida, rendono Yard un vero e proprio sistema d'arredo: il contenitore retro divano a giorno e il tavolino a "C" Court Yard, elementi in rovere termotrattato con struttura in metallo verniciato bronzo. Completano il sistema la mensola retro divano e l'elemento terminale con cassetto e vano a giorno.

Two complements that, combined in the encounter with the soft part, make Yard a real furnishing system: the back open sofa container and the "C" Court Yard coffee table, heat-treated oak elements with bronze painted metal structure. The system is completed by the shelf behind the sofa and the terminal element with drawer and open box.

Lennox

Equilibrate citazioni retrò per il divano due posti Lennox. Dall'animo leggero, fusione di proporzioni e riduzioni. Come una corolla sospesa sulla leggera struttura in metallo, Lennox è un divano da conversazione elegante e discreto, ideale per completare raffinate zone lounge e spazi di attesa.

Balanced retro quotes for the Lennox two-seater sofa. With a light soul, fusion of proportions and reductions. Like a corolla suspended on the light metal structure, Lennox is an elegant and discreet conversation sofa, ideal for completing refined lounge areas and waiting areas.

Design:
Gordon Guillaumier





Divano, Sofa Lennox
Tavolino, Coffee Table Ortis



Kaiwa

Design:
Matteo Nunziati

Il divano a due posti Kaiwa con base sospesa in metallo, seduta e schienale imbottiti è un raffinato passepartout capace di inserirsi in contesti domestici ma pensato in modo particolare per spazi contract. Il nome, dal giapponese "conversare", è evocativo.

The Kaiwa two-seater sofa with suspended metal base, padded seat and back seat is a refined passe-partout able to fit into domestic contexts but especially designed for contract spaces. The name, from the Japanese "to converse", is evocative.





Divano, Sofa Kaiwa
Tavolino, Coffee Table Sign

Taiki

Discreto ed elegante,
il divano a due posti Taiki
si racconta nella razionalità
dei volumi: la struttura
in legno è mitigata
dall'avvolgente imbottitura
che invita al relax.
Come una nuvola morbida
sospesa, racchiusa da una
leggera gabbia in legno.

Discreet and elegant,
the two-seater Taiki sofa
tells itself in the rationality
of the volumes: the wooden
structure is mitigated
by the enveloping padding
that invites relax.
Like a soft suspended
cloud, enclosed by a light
wooden cage.

Design:
Chiara Andreatti





Divano, Sofa Taiki
Tavolino, Coffee Table Flowers



Yaki

Design:
Gabriele&Oscar Buratti

In tre dimensioni, il divano letto Yaki si caratterizza per il particolare meccanismo che consente con un semplice movimento, senza togliere cuscinerie ingombranti, di ricavare un letto matrimoniale con rete a doghe e materasso confortevole. Estremamente comoda la tasca ricavata nello schienale per riporre i guanciali.

In three dimensions, the Yaki sofa bed is characterized by the particular mechanism that allows you to obtain a double bed with slatted base and comfortable mattress with a simple movement without removing bulky cushions. The pocket in the back for storing the pillows is extremely comfortable.

Dal disegno elegante curato nei dettagli, il divano letto Yaki è una soluzione dallo spirito contemporaneo pensata per rispondere a particolari esigenze d'uso sia in ambito domestico che nel settore dell'hotellerie e dei grandi progetti multi-apartment.

With an elegant design with care to detail, the Yaki sofa bed is a solution with a contemporary spirit designed to meet particular needs for use both in the home and in the hotel industry and large multi-apartment projects.



Divano Letto, Sofa Bed **Yaki**
Tavolino, Coffee Table **Flowers**

Pouf **Pouf**
Armadio, Wardrobe **Kyn**

ARMCHAIRS

Per ogni ambiente, dal living alla zona notte, perfette in raffinate zone lounge, Lema propone una collezione ampia di sedute votate ai momenti condivisi, al contempo rifugi personali dove dedicarsi alla lettura, all'ascolto della musica, al relax. A caratterizzarle sono dettagli sartoriali che donano ad ognuna identità distintive. Diverse tra loro, dal gusto più classico o contemporaneo, dalle forme sinuose o più discrete, con strutture in legno o metallo e rivestimenti in tessuto e pelle.

For every room, from the living room to the sleeping area, perfect in refined lounge areas, Lema offers a large collection of seats devoted to shared moments, at the same time personal refuges where you can devote yourself to reading, listening to music, relaxing. To characterize them are tailored details that give each distinctive identity. Different from each other, with a more classic or contemporary taste, with sinuous or more discreet shapes, with wooden or metal structures and fabric and leather upholstery.





Maddix

Il carattere espressivo di Maddix racconta la bellezza di materiali naturali come il legno e il cuoio. Anima di Maddix è infatti il suggestivo dialogo tra due elementi: la struttura aerea in frassino tinto rovere termotrattato, dai profili sagomati, sostiene lo schienale in cuoio light.

The expressive character of Maddix tells the beauty of natural materials such as wood and leather. Core of Maddix is in fact the evocative dialogue between two elements: the air structure in heat-treated oak-stained ash, with shaped profiles, supports the back in light leather.

Design:
Dainelli Studio





Proporzioni equilibrate per Maddix, perfetta in ogni ambiente, nel living come in camera da letto o in eleganti zone lounge. Il comfort è assicurato dai morbidi cuscini a quote differenziate di seduta e schienale.

Balanced proportions for Maddix, perfect in any room, in the living room as in the bedroom or in elegant lounge areas. Comfort is ensured by the soft cushions with different densities of the seat and back seat.





Poltrona, Armchair Claire
Madia, Sideboard Rainbow

Claire

Design:
Norm Architects



La poltrona Claire è un invito a sedersi comodamente e vivere un'esperienza di completo relax nel comfort e nel piacere. Il suo spirito retrò e la potenza aggraziata del suo design risiedono nella forma alta e arrotondata dello schienale, nel controllo delle linee rette e nell'equilibrio delle curve. In contrasto con la generosa imbottitura, l'esile struttura metallica crea un effetto armonioso che garantisce stabilità strutturale e visiva.

The Claire armchair is an invitation to sit comfortably and live an experience of complete relaxation in comfort and pleasure. Its retro spirit and graceful power of its design reside in the tall, rounded shape of the backrest, the control of straight lines and the balance of curves. In contrast to the generous padding, the slender metal structure creates a harmonious effect that guarantees structural and visual stability.

Lucylle

Lucylle è una poltrona dal carattere ricercato che si definisce nelle proporzioni classiche e accoglienti, capaci di inserirsi in ogni contesto progettuale. Grazie alla tecnologia evoluta assicura massimo comfort e leggerezza.

Lucylle is an armchair with a refined character that defines itself in classic and welcoming proportions, able to fit into any design context. Thanks to advanced technology, it ensures maximum comfort and lightness.

Design:
Roberto Lazzeroni



Poltrona, Armchair **Lucylle**
Tavolino, Coffee Table **Ortis**



La struttura in massello di frassino tinto rovere termotrattato ha imbottiture morbide e rivestimenti in tessuto o pelle impreziositi da cuciture ribattute che sottolineano l'anima più sartoriale di Lema.

The structure in heat-treated oak stained solid ash has soft padding and fabric or leather upholstery embellished with riveted seams that underline the more tailored soul of Lema.



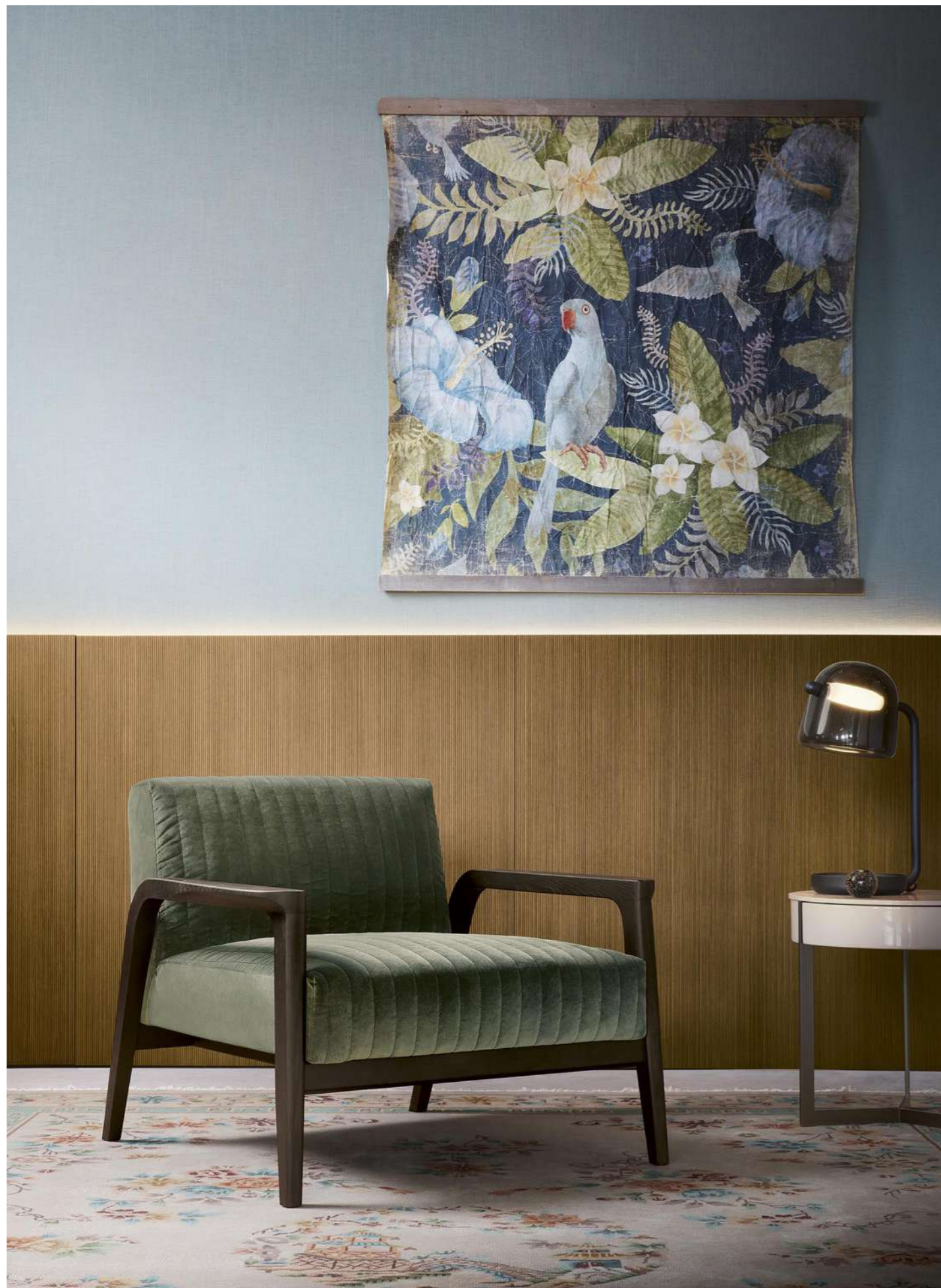

Poltrona, Armchair **Tarsia**
Tavolino, Coffee Table **Sign**

Tarsia

Animo ricercato per Tarsia, poltrona dal carattere asciutto ma al contempo molto confortevole. Le forme sagomate della struttura in legno massello invitano gambe e braccioli a sostenere i volumi definiti del cuscino di seduta e schienale.

An elegant soul for Tarsia, an armchair with a thin core at the same time very comfortable. The shapes of the solid wood structure outline legs and armrests to support the defined volumes of the seat and back cushion.

Design:
Matteo Nunziati





Interpretando in chiave progettuale contemporanea le tecniche tradizionali dell'uso del legno massello, Tarsia assicura massimo comfort grazie all'imbottitura a quote differenziate dei cuscini e alla lieve inclinazione dei braccioli che accompagna la postura del corpo.

By interpreting the traditional techniques of using solid wood in a contemporary design key, Tarsia ensures maximum comfort thanks to the padding at different heights of the cushions and the slight inclination of the armrests that accompanies the body posture.



Poltrona, Armchair **Alton**
Scrivania, Desk **Victoria**

Alton

Design:
David Lopez Quincoces

Carattere scultoreo
per Alton con struttura in
metallo a definirne la forma
a semicerchio che accoglie
la sagoma asciutta dello
schienale con particolare
lavorazione sartoriale
realizzata con oltre 200
metri di corda di cuoio
naturale invecchiato
o cotone cerato.

Sculptural character for
Alton with metal structure
to define its semicircle shape
which welcomes the thin
shape of the back seat with
a particular tailoring process
made with over 200 meters
of aged natural leather cord
or waxed cotton.





Poltroncina Alton, realizzata con cordino in cuoio naturale riavvolto a mano. I cuscini di seduta e schienale sono rivestiti con tessuto Cassiopea.

Alton armchair, made with a natural, hand-twisted leather cord. The seat and back cushions are upholstered with Cassiopea fabric.



Poltrona, Armchair **Alton**
Tavolino, Coffee Table **Cruise**



A creare un raffinato contrasto stilistico, il rigore delle linee esterne si fonde nell'avvolgente seduta, con rivestimento in tessuto o pelle. Un morbido cuscino garantisce massimo comfort di seduta.

To create a refined stylistic contrast, the rigor of the external lines merges into the enveloping seat, with fabric or leather upholstery. A soft cushion guarantees maximum seating comfort.



Bice

Forme accoglienti e animo vintage per la lounge-chair Bice, perfetta dal living alla camera da letto; ideale anche in rilassate zone lounge. Con rivestimento in tessuto o pelle, si caratterizza per la struttura in metallo bronzato.

Cozy shapes and vintage spirit for the Bice lounge chair, perfect from the living room to the bedroom; also ideal in relaxed lounge areas. With fabric or leather upholstery, it is characterized by the bronzed metal structure.

Design:
Roberto Lazzeroni

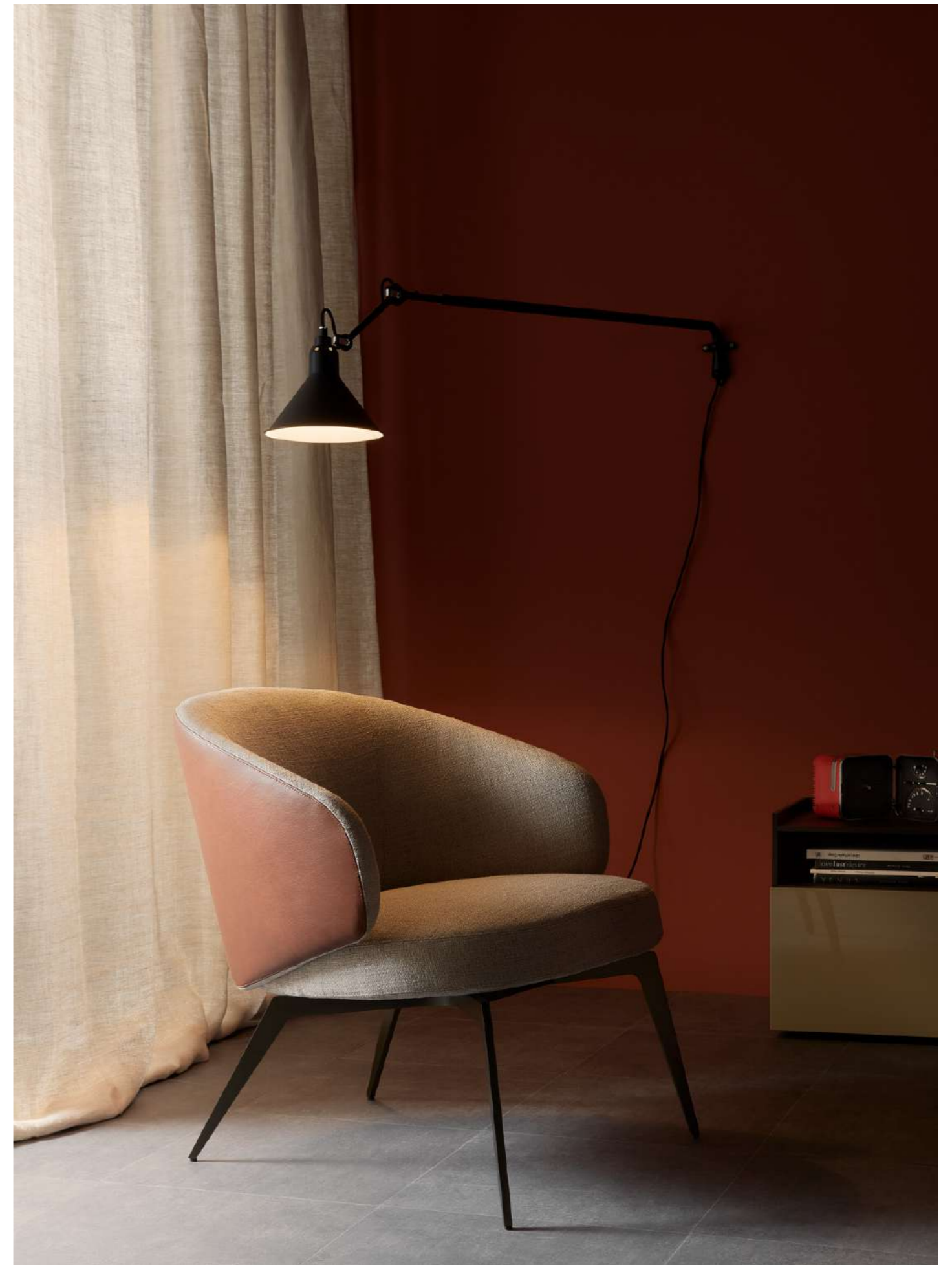
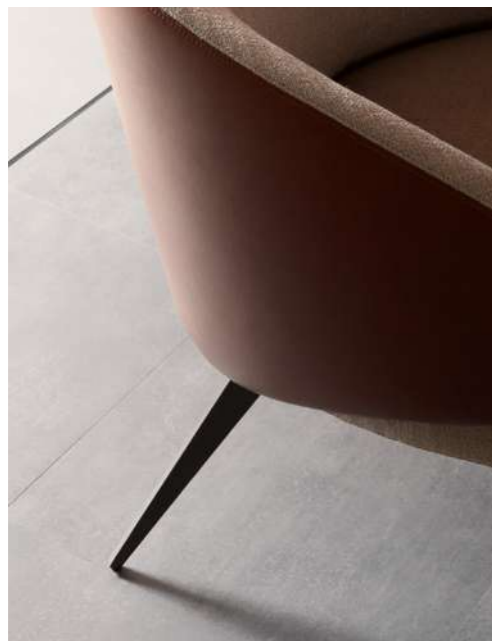





Dormeuse **Eydo**
Tavolino, Coffee Table **Flowers**

Eydo

Design:
Francesco Rota

La dormeuse Eydo si caratterizza per la linea fluida e l'elegante asimmetria. Leggera e slanciata grazie alla struttura in metallo verniciato bronzo e alla forma ad ala del volume unico seduta-schienale, Eydo ha spessori ridotti, preziose cuciture impunturate e rivestimento in pelle. Un design pulito, fatto di dettagli, studiato per coniugare bellezza e comfort.

The Eydo daybed is characterized by fluid lines and elegant asymmetry. Light and slim thanks to the bronze painted metal structure and the wing shape of the single volume seat and back, Eydo has reduced thicknesses, refined stitching and leather upholstery. Clean design, composed of details and designed to combine beauty and comfort.



Fantino

La poltrona Fantino richiama vagamente la forma di una sella da cavallo montata sulla base in frassino tinto rovere termotrattato. L'imbottitura morbida ma asciutta riduce il volume complessivo, bilanciando le proporzioni pur mantenendo inalterato il comfort. Il rivestimento è in tessuto o pelle con cuciture profilate in gros grain.

The Fantino armchair vaguely recalls the shape of a horse saddle mounted on the base in heat-treated oak stained ash. The soft but dry padding reduces the overall volume, balancing the proportions while maintaining the comfort unchanged. The upholstery is in fabric or leather with profiled seams in grosgrain.

Design:
Gordon Guillaumier



Poltrona, Armchair **Fantino**
Modular System **Selecta**

Felix

Linee sinuose e delicate disegnano Felix: un vero e proprio guscio di relax grazie allo schienale curvato che racchiude la seduta monolitica. Cuciture e impunture sono dettagli preziosi.

Sinuous and delicate lines draw Felix: a real shell of relax thanks to the curved backrest that encloses the monolithic seat. Seams and stitching are precious details.

Design:
Roberto Lazzeroni



Lady Jane

Una bergère ispirata alle forme del design anni Cinquanta: Lady Jane è progettata per gli spazi della casa, ma anche del lavoro. Il morbido rivestimento in pelle o in tessuto si sposa con eleganza al color bronzo della base in acciaio, disponibile anche in versione girevole. Il risultato è un oggetto classico, senza tempo, che unisce comfort e bellezza.

A bergère inspired by the forms of the fifties design: Lady Jane is designed for the spaces of the home, but also of work. The soft leather or fabric covering is elegantly combined with the bronze colour of the steel base, also available in a swivel version. The result is a timeless classic object that combines comfort and beauty.

Design:
Christophe Pillet

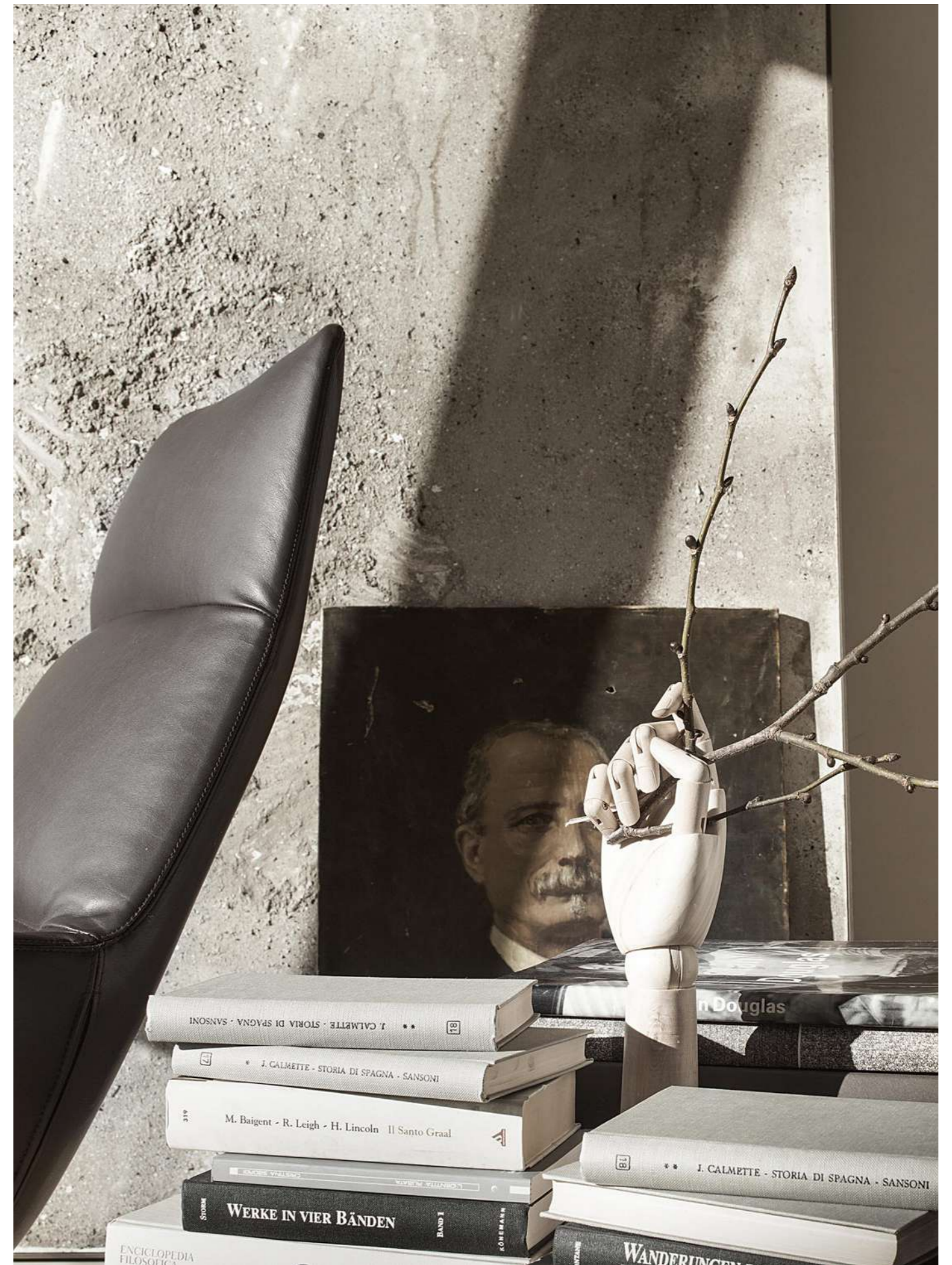



Contaminazioni di stili per una seduta poetica eppure rigorosa che si completa con il pouf poggiatesta imbottito con struttura in metallo color bronzo, per godere dei momenti più rilassanti.

Contaminations of styles for a poetic yet rigorous sitting that is completed with the padded footrest pouf with metal structure in bronze colour, to enjoy the most relaxing moments.



Lennox

Leggera nelle proporzioni,
informale nel carattere
dall'innata eleganza.
Poltrona da conversazione
o lettura, Lennox nasce
come nido per ascoltare
musica così come suggerisce
il nome liberamente ispirato
alla nota cantante.

Light in proportions, informal
in character with innate
elegance. Conversation
or reading armchair, Lennox
was born as a nest for
listening to music as the
name freely inspired by
the famous singer suggests.

Design:
Gordon Guillaumier





Poetica come un fiore aperto sospeso nel vuoto, Lennox si completa con il pouf, rivestibile in pelle o tessuto: una superficie pratica e morbida a rendere ancora più comoda la seduta.

Poetic like an open flower suspended in space, Lennox is completed with the pouf, which can be covered in leather or fabric: a practical and soft surface to make the seat even more comfortable.





Popsi

La base è una leggera ragnatela realizzata con un tondino metallico; la seduta a pozzetto è rivestita in cuoio con cuciture estetiche, a sottolineare le curve sinuose del petalo. È Popsi, lounge chair ricercata per materiali e complessità di disegno.

The base is a light web formed of metal rods; the tub-shaped seat is lined in leather with attractive stitching and emphasizes the sinuous curves of the petal. This is Popsi, a lounge chair of particular refinement due to the materials and design complexity.

Design:
Ferruccio Laviani



Poltrona, Armchair **Popsi**
Tavolino, Coffee Table **Sign**

Taiki

Design:
Chiara Andreatti



Taiki reinterpreta forme classiche attraverso l'accogliente imbottitura che invita al relax. Il dettaglio d'impronta manifatturiera delle cuciture conferisce uno spirito attuale mentre la struttura in frassino tinto rovere termotrattato sceglie un rigore dallo spirito orientale.

Taiki reinterprets classic shapes through the welcoming padding that invites relax. The manufacturing imprint detail of the seams gives it a contemporary spirit while the heat-treated oak stained ash structure chooses a rigor with an oriental spirit.





Occidentale nell'estetica d'impronta classica, orientale nella sua poetica minimale. Al centro del progetto di Taiki, l'imbottito morbido e accogliente, un giro unico che prende schienale e braccioli racchiuso nell'essenzialità della struttura.

Western in the classic aesthetic, Eastern in its minimal poetics. At the center of the Taiki project, the soft and welcoming padding, a unique turn that takes the backrest and armrests enclosed in the essentiality of the structure.



Yard Daybed

Yard Daybed nasce come oggetto dalle molteplici funzioni. Interpretabile come dormeuse, ma anche superficie di appoggio, è caratterizzato dalla linea rigorosa e nitida della struttura in metallo di gusto razionalista. Una presenza sobria, di grande classe, nella preziosa versione in pelle con impunture e base in metallo verniciato bronzo.

Yard Daybed was born as an object with multiple functions. Interpretable as a dormeuse, but also a support surface, it is characterized by the rigorous and clear line of the rationalist-style metal structure. A sober, classy presence in the precious leather version with stitching and base in bronze painted metal.

Design:
Francesco Rota

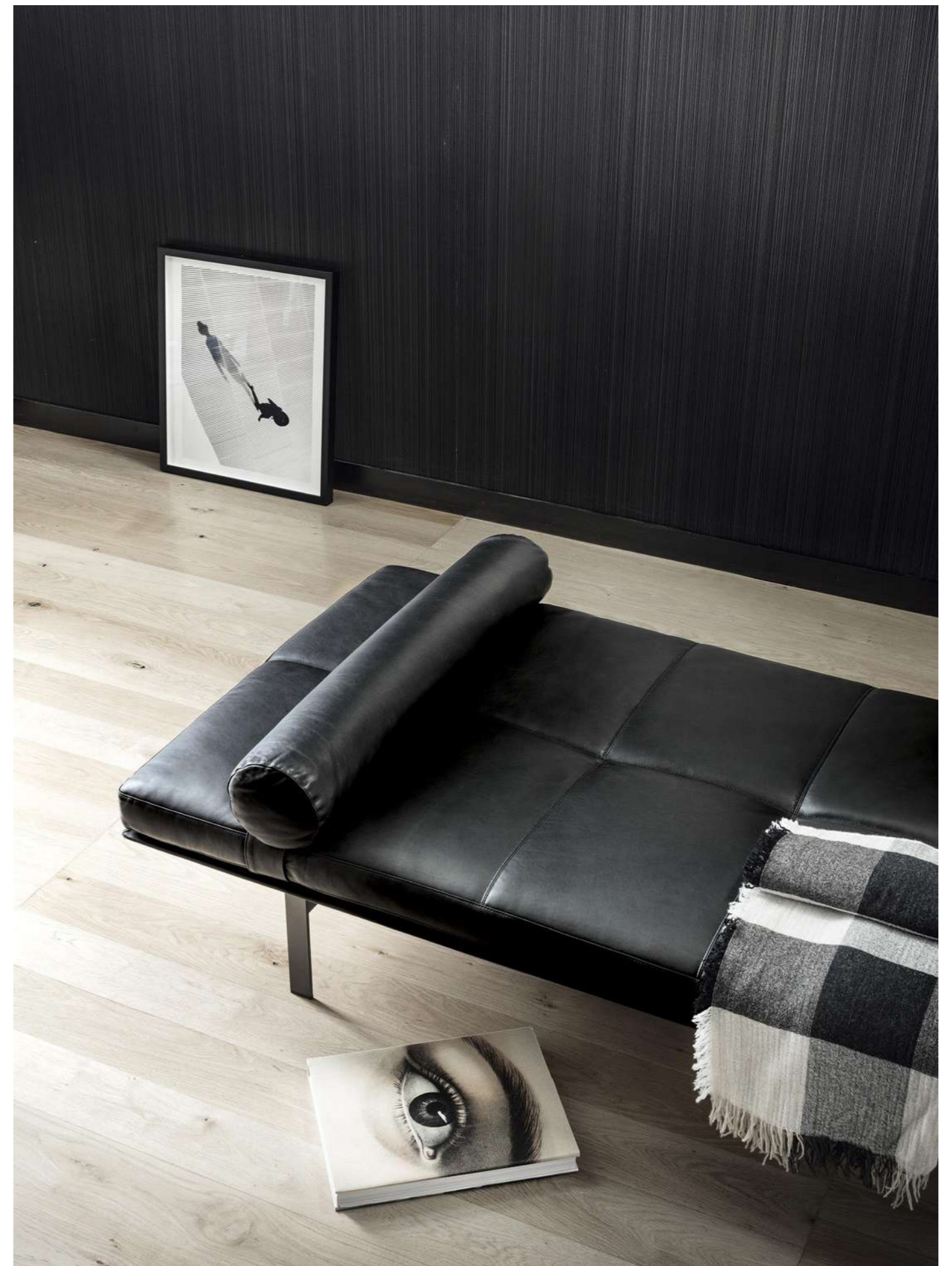



POUFS AND BENCHES

Equilibrato incontro di estetica e funzione, i pouf e le panche Lema sono micro architetture che muovono e arricchiscono gli spazi. Oggetti la cui unicità si definisce nell'accurato disegno, pensati per dialogare con le altre proposte del vasto catalogo Lema, al contempo capaci di vivere liberamente in ogni progetto d'arredo, residenziale e non.

Balanced meeting of aesthetics and function, Lema poufs and benches are micro architectures that move and enrich spaces. Objects whose uniqueness is defined in the careful design, designed to dialogue with the other proposals of the ample Lema catalogue, at the same time capable of living freely in any furnishing project, residential and not.

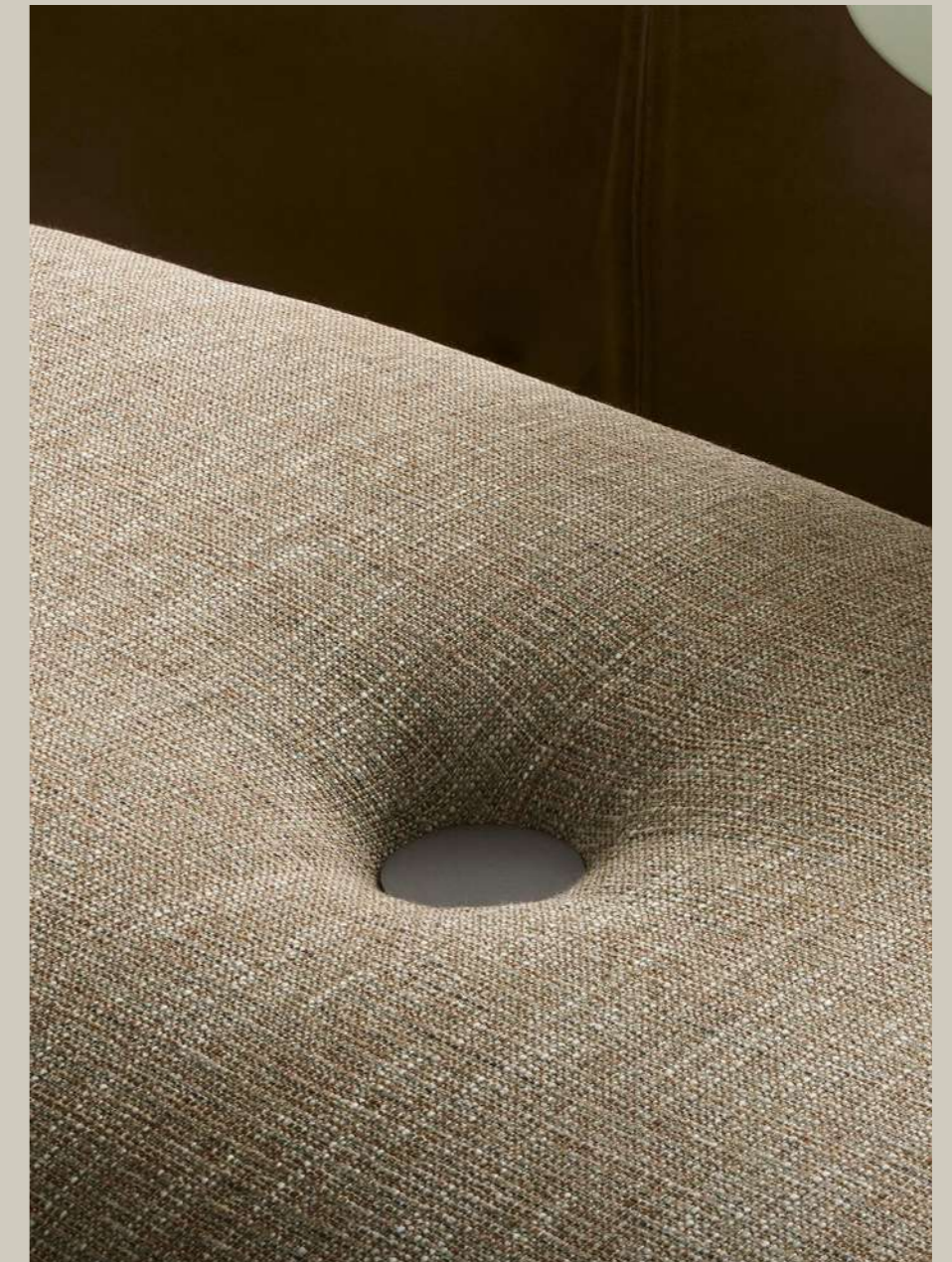

Aley

Design:
Gabriele&Oscar Buratti

Pouf a terra caratterizzato da morbidi volumi monomaterici, Aley è previsto in due forme: tondo ed ovale. Un bottone centrale, piccolo dettaglio che risalta le leggere curve che accolgono chi si siede; realizzabile in tessuto, pelle e pelle sintetica a scelta tra le proposte nel campionario Lema.

Floor standing pouf characterized by soft single-material volumes, Aley is available in two forms: round and oval. A central button, a small detail that highlights the light curves that welcome those who sit; available in fabric, leather and synthetic leather chosen from the proposals in the Lema sample book.

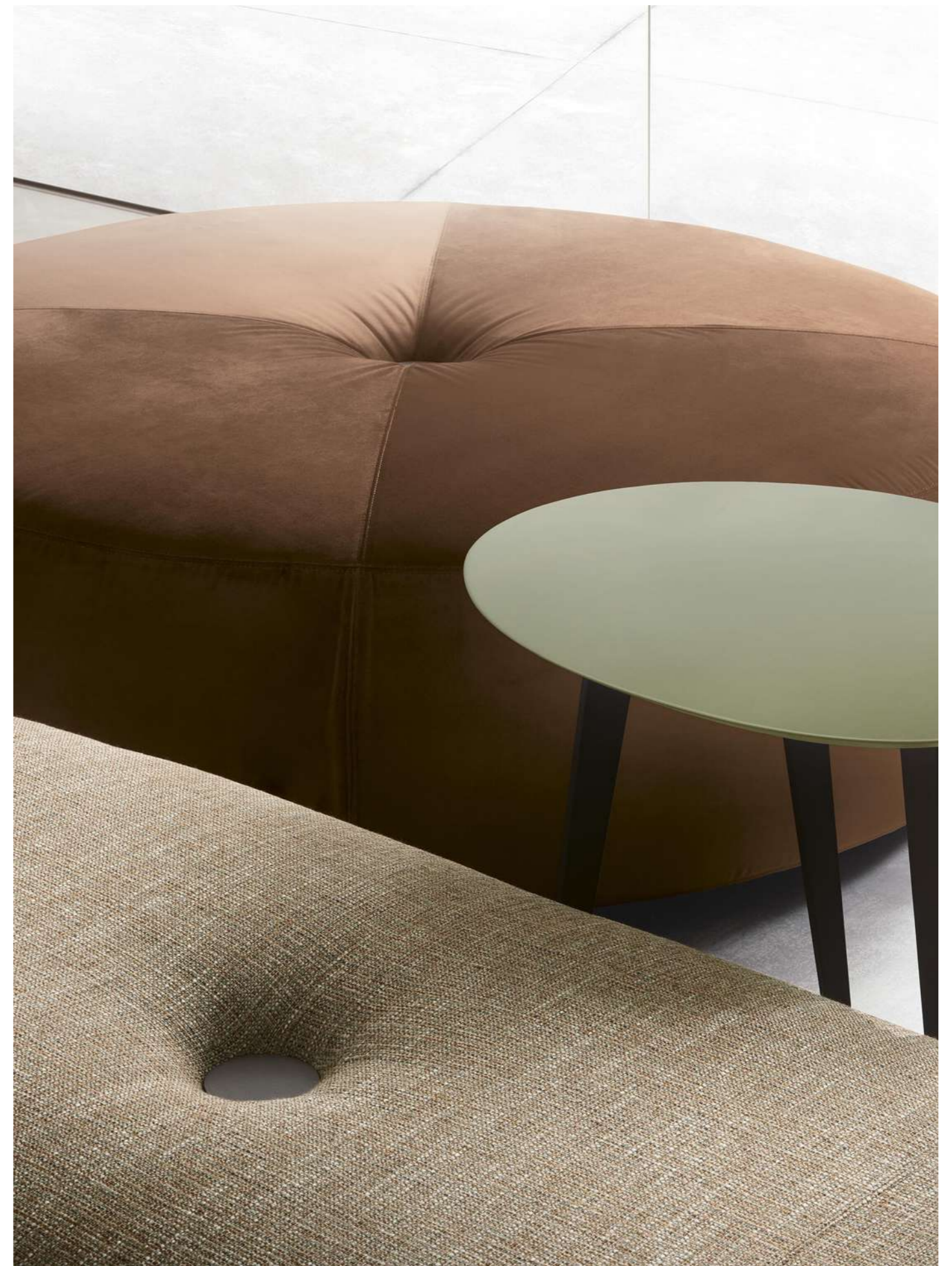



Informale nel carattere, concepito come una cometa in movimento libero nello spazio abitativo. Elemento da usare singolo, in coppia o in gruppo a formare sedute collettive, dal layout ricercato ideali per arredare aree lounge di bar e hotel, spazi di attesa e lavoro.

Informal in character, conceived as a free moving comet in the living space. Element to be used single, in pairs or in groups to form collective seats, with a refined layout ideal for furnishing lounge areas of bars and hotels, waiting and work spaces.

Pouf **Aley**
Tavolino, Coffee Table **Flowers**



Notch

Design:
Johan Lindstén

Oggetto dall'animo ironico, nomade nel pensiero, in due dimensioni da usare singolarmente o in coppia, si distingue per la morbidezza della seduta rivestita in tessuto. Altra peculiarità di Notch sono i ricercati particolari come le cinghie in cuoio naturale invecchiato dotate di maniglie per renderne più agevole lo spostamento, combinando valore estetico e funzionale.

An ironic object, nomadic in thought, in two dimensions to be used individually or in pairs, it stands out for the softness of the seat covered in fabric. Another peculiarity of Notch are the refined details such as the straps in aged natural leather equipped with handles to make it easier to move, combining aesthetic and functional value.



Pouf

Puro nelle forme, Pouf è un complemento d'arredo che definisce il carattere essenziale e versatile nel nome che fa proprio il sostantivo comune. In due forme, cilindrica e cubica da rivestire in tessuto, pelle, pelle sintetica, interpreta con disinvoltura il ruolo di seduta, piano d'appoggio, poggiatesta.

Pure in its forms, Pouf is a furnishing accessory that defines the essential and versatile character in the name that makes the common noun its own. In two shapes, cylindrical and cubic to be covered in fabric, leather, synthetic leather, it casually plays the role of seat, table top, footrest.

Design:
Officinadesign Lema



Tod

Design:
Ferruccio Laviani



Dal vibrante twist inconsueto: Tod è un pouf imbottito in pelle caratterizzato dalla silhouette organica, dove sono i dettagli a definirne la carica espressiva. Ideale sintesi tra industrial design e alto artigianato, i volumi definiti sono tagliati dalle cuciture impunturate a rilievo che sottolineano la grande maestria sartoriale di Lema.

With a vibrant unusual twist: Tod is a pouf upholstered in leather characterized by an organic silhouette, where the details, define its expressive charge. Ideal synthesis between industrial design and high craftsmanship, the defined volumes are cut by the stitching in relief that underline the great tailored skill of Lema.

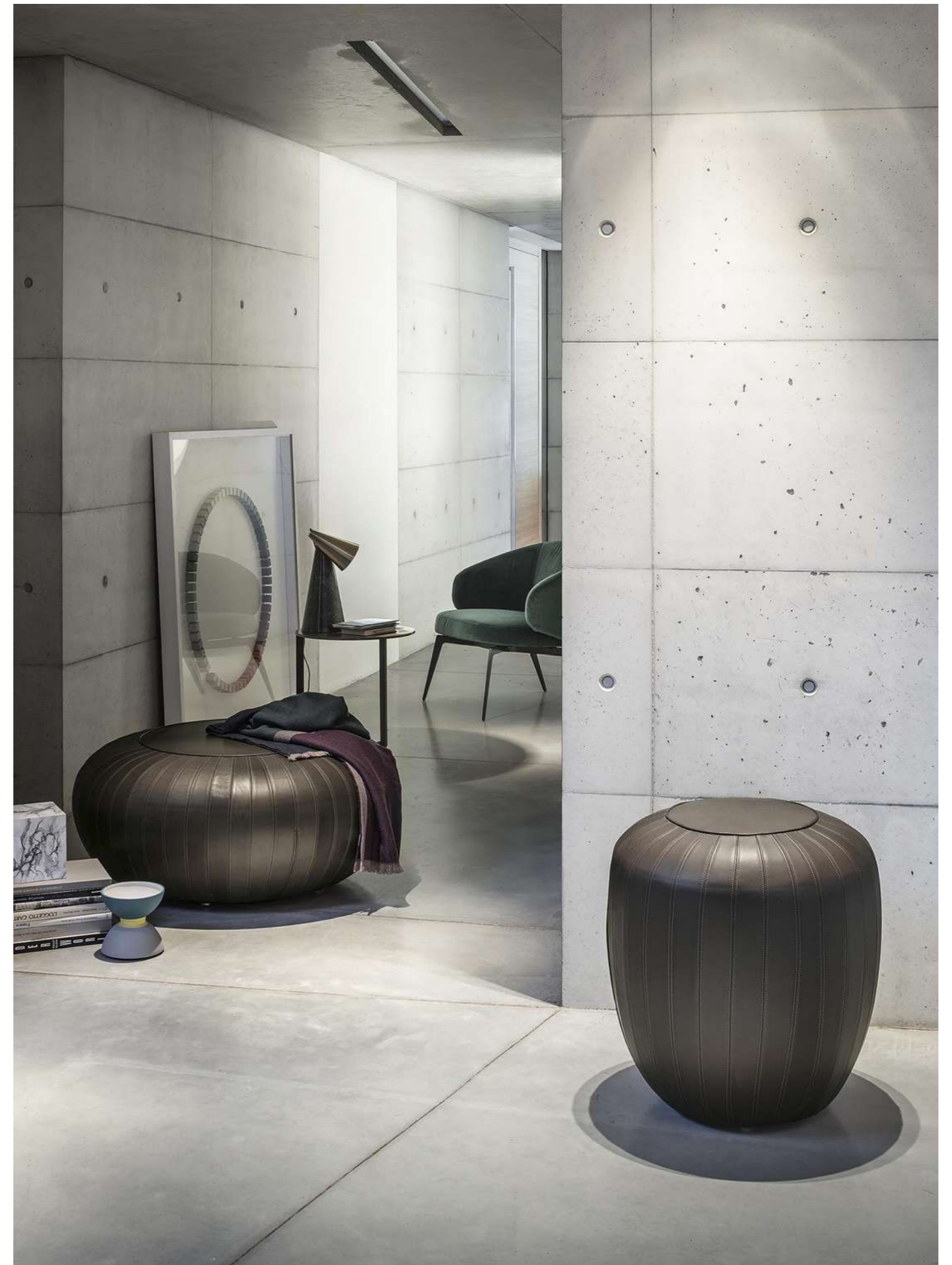

Uma

Elegante nell'estetica discreta e nell'innata versatilità, Uma abita con leggerezza lo spazio domestico: perfetta sia a fondo letto sia nel living o nell'ingresso. Il carattere sofisticato si identifica nella semplicità delle linee e del loro movimento enfatizzato dall'abbinamento di diversi materiali.

Elegant in discreet aesthetics and innate versatility, Uma lives lightly in the domestic space: perfect both at the bottom of the bed and in the living room or entrance. The sophisticated character is identified in the simplicity of the lines and their movement emphasized by the combination of different materials.

Design:
Federica Biasi

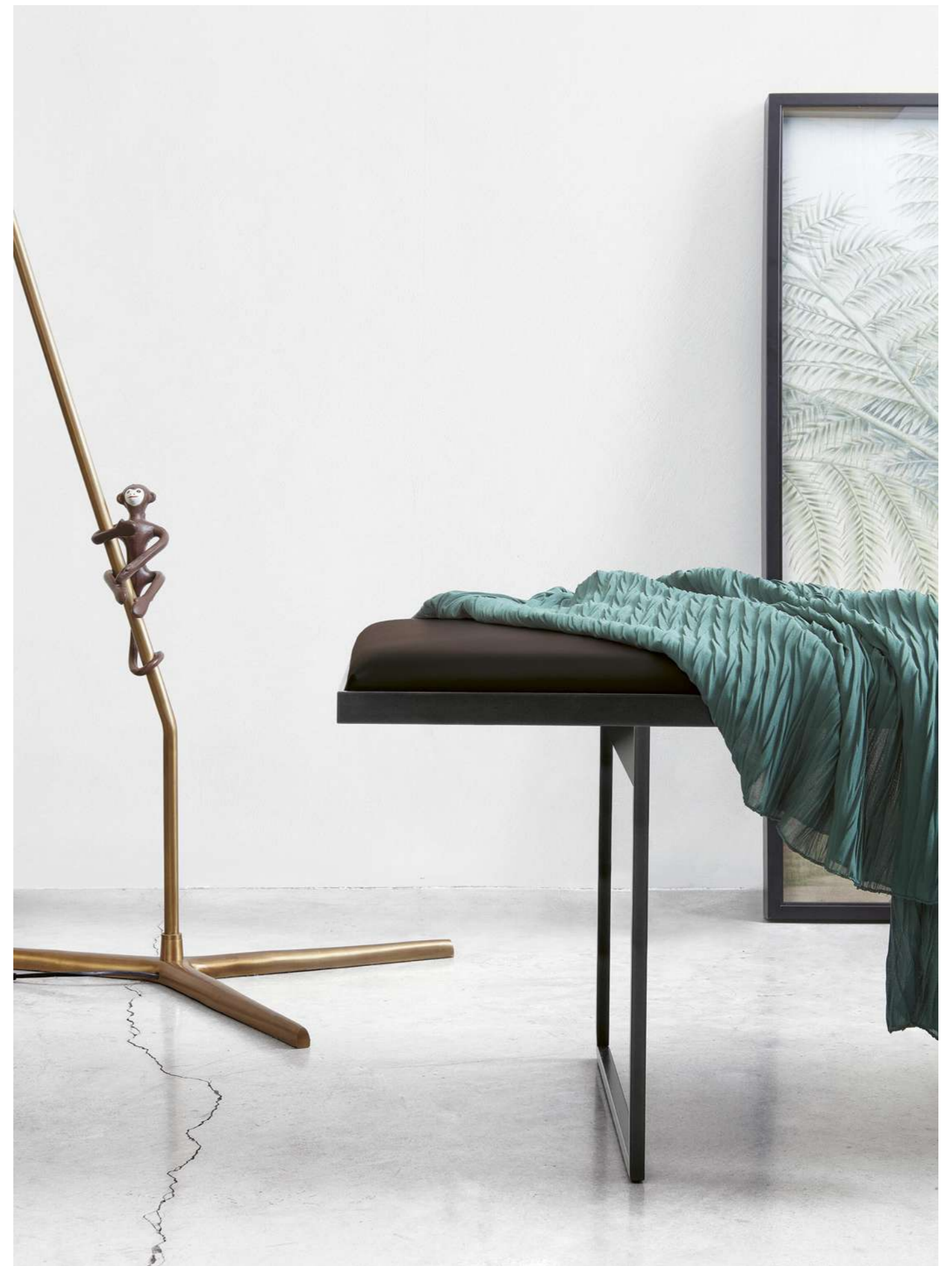

Uma si caratterizza per la doppia struttura in metallo verniciato bronzo che accoglie la seduta imbottita con doppio cuscino in pelle o pelle sintetica e il vassoio in rovere termotrattato integrato alla struttura, a lato o al centro, con inserti millerighe, pensato come vuota tasche.

Uma is characterized by the double structure in bronze painted metal, which welcomes the padded seat with double cushion in leather or synthetic leather and the heat-treated oak tray integrated into the structure, on the side or in the centre, with plot inserts, designed as an empty pocket.



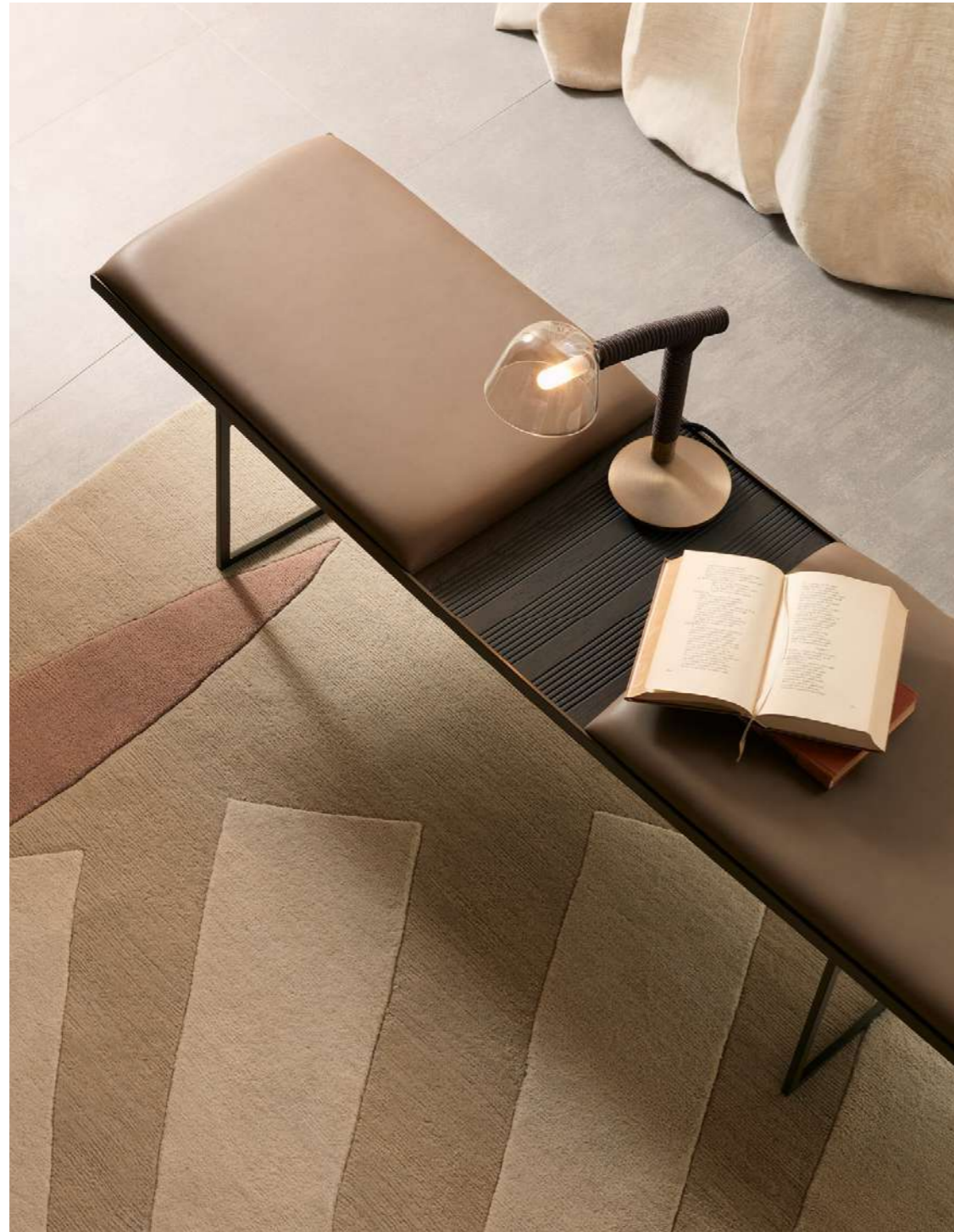



Fence

Design:
Christophe Pillet

Fence è disegnata con il preciso intento di assolvere alla doppia funzione di seduta e superficie d'appoggio. Il suo disegno leggero e sofisticato accosta l'effetto wire frame della fascia continua dei tondini di metallo trattato alla compattezza del top in massello di noce canaletto.

Fence is designed with the specific intent of fulfilling the dual function of seat and support surface. Its light and sophisticated design combines the wire frame effect of the continuous band of the treated metal with the compactness of the solid canaletto walnut top.



Adatta per una collocazione libera nell'ambiente giorno ma anche nella zona notte, Fence è un oggetto d'arredo che trae forza e personalità dalle linee essenziali, puntando al contrasto tra la naturalità del legno e l'industrialità del metallo.

Suitable for a free placement in the living room but also in the sleeping area, Fence is a piece of furniture that draws strength and personality from essential lines, aiming at the contrast between the naturalness of wood and the industriality of metal.

TECHNICAL INDEX

Sofas — 232

Armchairs — 249

Poufs — 255

Benches — 256



Sofas

Aberdeen – p. 68

Struttura: base e schienale in legno massello e derivati, con molleggio garantito da cinghie elastiche. Imbottitura in poliuretano espanso a quote differenziate. Cuscini seduta, schienale: imbottitura in poliuretano espanso e finitura della parte superiore in High-tex, materiale innovativo ad alta tecnologia. Esecuzione: rivestimento tessuto collezione Aberdeen sfoderabile. Disponibile con ruote in acciaio rivestite in gomma o con piedini in legno massello verniciato.

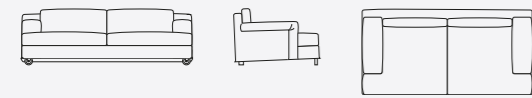

L. 2000 - 2300 H. 660 P. 1010
W. 78¾" - 90½" H. 26" D. 39¾"

Structure: base and backrest in solid wood and multiply wood with elastic webbing suspension. Padding in variable density, polyurethane foam. Seat, backrest cushions: padding in polyurethane foam with the upper portion in innovative High-tex quilt. Finishing: fabrics covering from Aberdeen collection removable. Available with rubber tired steel castors or solid wood feet.

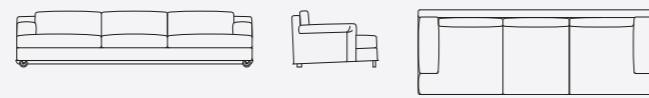

L. 2780 H. 660 P. 1010
W. 109½" H. 26" D. 39¾"

Cloud – p. 76

Struttura: base e schienale in legno massello e derivati, multistrati con molleggio garantito da cinghie elastiche. Imbottitura in poliuretano espanso a quote differenziate. Rivestimento in tessuto, ecopelle, pelle. Sfoderabile in tessuto. Piedini in ABS nero.

Structure: base and backrest in solid wood and multiply wood with elastic webbing suspension. Padding in expanded polyurethane, plywood with spring guaranteed by elastic straps. Finishing in fabric, synthetic leather, leather covering. Removable cover in fabric. Padding in variable density, polyurethane foam. Black ABS feet.

Elemento
Unit
P. 1080 - D. 42½"



SX

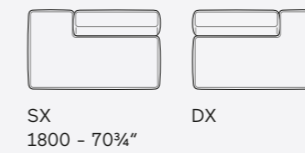

SX
1800 - 70¾"

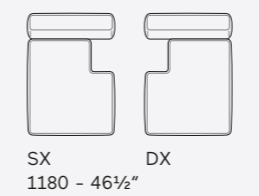

SX
1180 - 46½"

Elemento
Unit
P. 1180 - D. 46½"

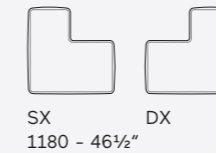

SX
1180 - 46½"

Elemento
Unit
P. 1080 - D. 42½"

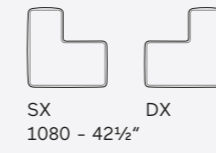

SX
1080 - 42½"

Bracciolo
Armrest
P. 450 - D. 17¾"



300 - 11¾"

600 - 23½"

Cuscino
supplementare
Additional cushion

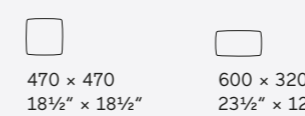

470 x 470
18½" x 18½"

600 x 320
23½" x 12½"

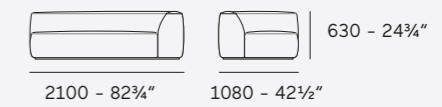

DX

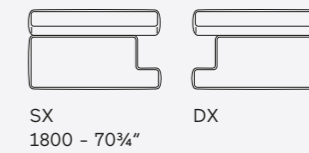

SX
1800 - 70¾"

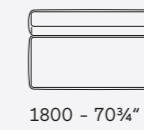

1800 - 70¾"

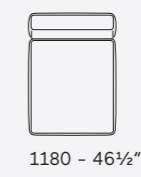

1180 - 46½"

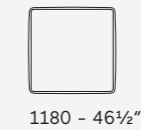

1180 - 46½"

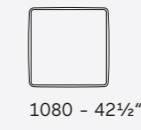

1080 - 42½"

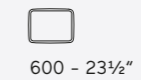

600 - 23½"

Bracciolo con vassoio
Armrest with tray
P. 450 - D. 17¾"

Sofas

Glee – p. 24

Capace di inserirsi in ogni ambiente e di dialogare con qualsiasi stile di arredamento, Glee fa della versatilità il suo tratto distintivo. È possibile scegliere la larghezza del divano modulare Glee con passo 5 cm tra la misura massima e la misura minima per adattarlo pienamente alle diverse esigenze funzionali, di spazio ed estetiche. L'attenta selezione di materiali, permette diverse combinazioni cromatiche e materiche dando vita a questa nuova proposta "su misura", emblema della ricerca costante di Officinadesign Lema.

Versatility is its distinctive trait: Glee is able to fit into any space and dialogue with any furniture style. It is possible to choose the width of the central body, of the two terminals and of the pouf with a 5 cm step between the maximum and the minimum size of these sofa's elements, in order to fully adapt them to different functional and aesthetic needs. The careful selection of materials allows different chromatic and material combinations, giving life to this new elegant "tailor-made" proposal, perfect symbol of Officinadesign Lema's constant research.

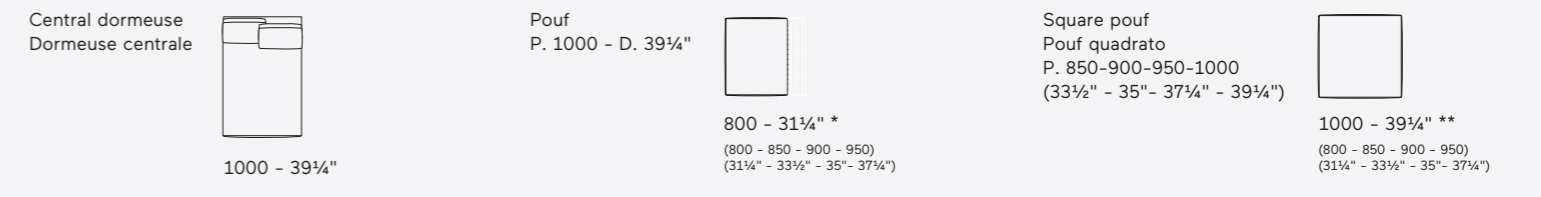
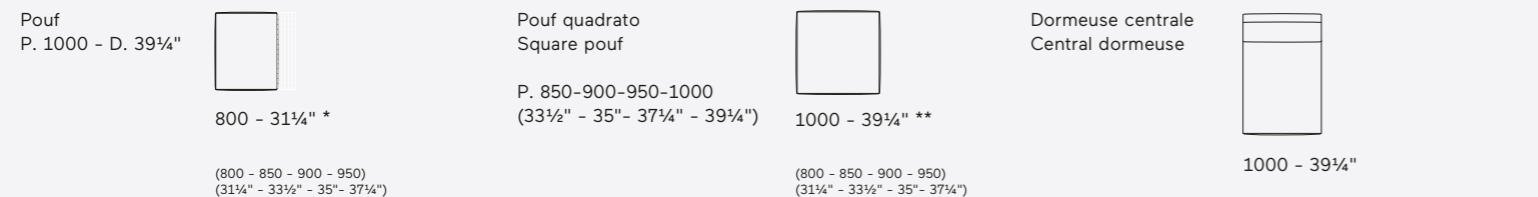
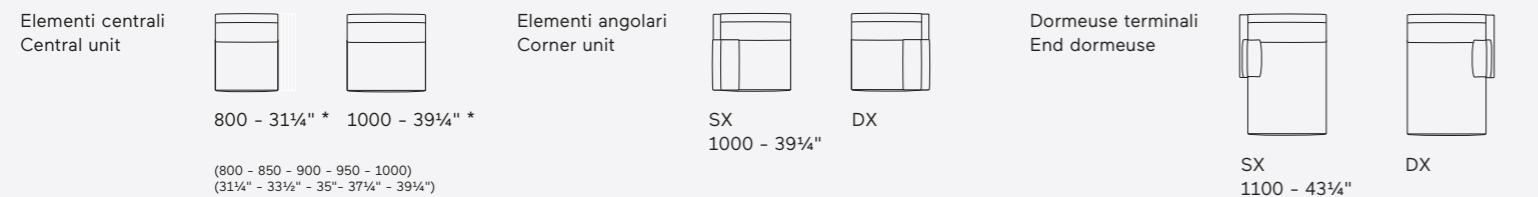
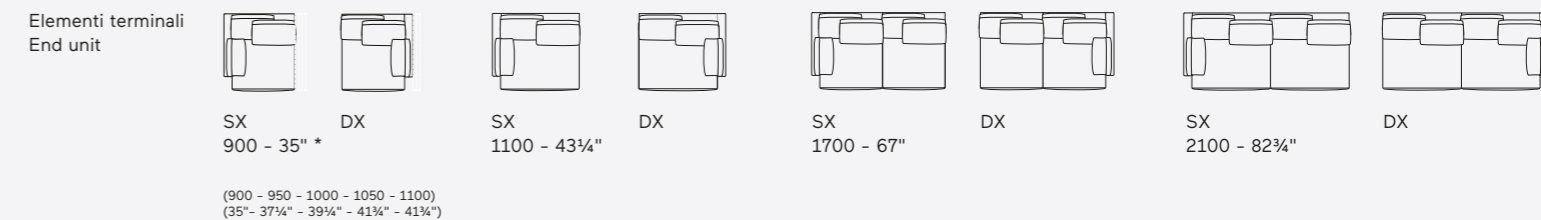
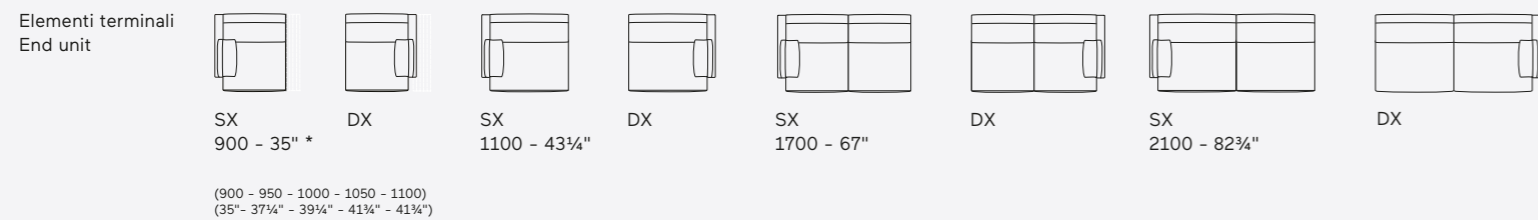
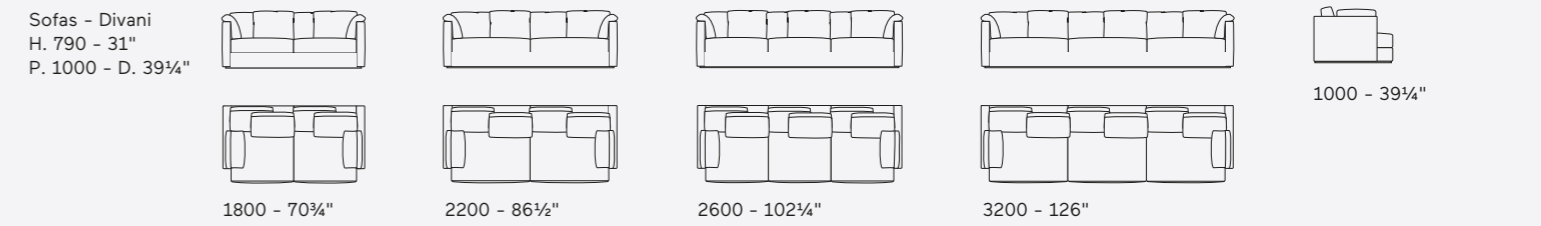
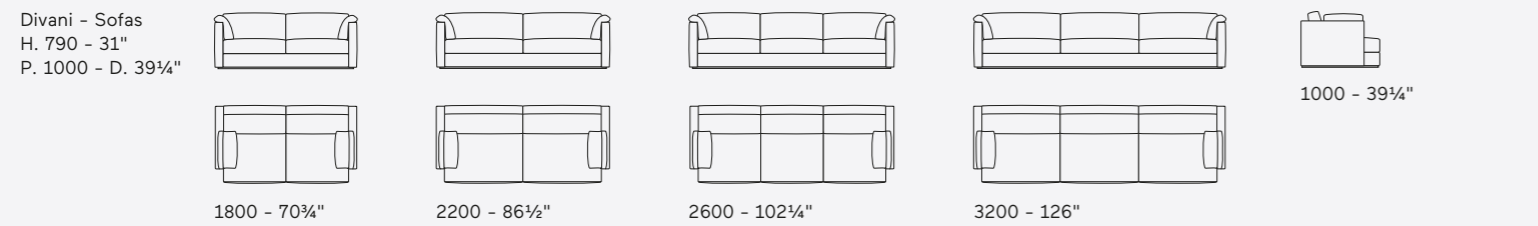

* Gli elementi con * sono quelli che possono variare in larghezza con passo 5cm.

** L'elemento con ** può variare con passo 5cm in larghezza e profondità. (mantiene la forma quadrata)

* Units marked * may vary with a 5 cm step in width.

** Units marked ** may vary in steps of 5cm in width and depth. (maintain square shape)

* Gli elementi con * sono quelli che possono variare in larghezza con passo 5cm.
* Units marked * may vary with a 5cm step in width.

** L'elemento con ** può variare con passo 5cm in larghezza e profondità. (mantiene la forma quadrata)
** Units marked ** may vary in steps of 5cm in width and depth. (maintain square shape)

Sofas

Groovy – p. 38

Gioco di incastri tra forme rigide e morbide: il divano modulare Groovy racchiude l'essenza del relax in una struttura esile e slanciata. Come petali che si schiudono, i suoi braccioli si aprono lievemente verso l'esterno portando in risalto la morbida cuscineria. L'equilibrio tra comfort e linearità, forme squadrate ed extra morbidezza, è il punto centrale attorno al quale Officinadesign Lema ha costruito il progetto del divano Groovy, perfetto interprete di una filosofia improntata al relax, che trova nel comfort e nella modularità i suoi caratteri fondamentali. Cura dei dettagli e alta personalizzazione definiscono inoltre questo divano, manifestando la qualità made in Italy in ogni suo particolare.

A game between rigid and soft shapes: the Groovy sofa embodies the essence of relaxation in a slender structure. A sofa that blooms with many petals, the armrests of Groovy open slightly outwards focusing on the soft cushions. Square shapes and extra softness: the balance between comfort and linearity is the central point around which Officinadesign Lema has built the whole project of the Groovy sofa, making it the perfect interpreter of a philosophy based on relaxation; where comfort and modularity are the fundamental characteristics.

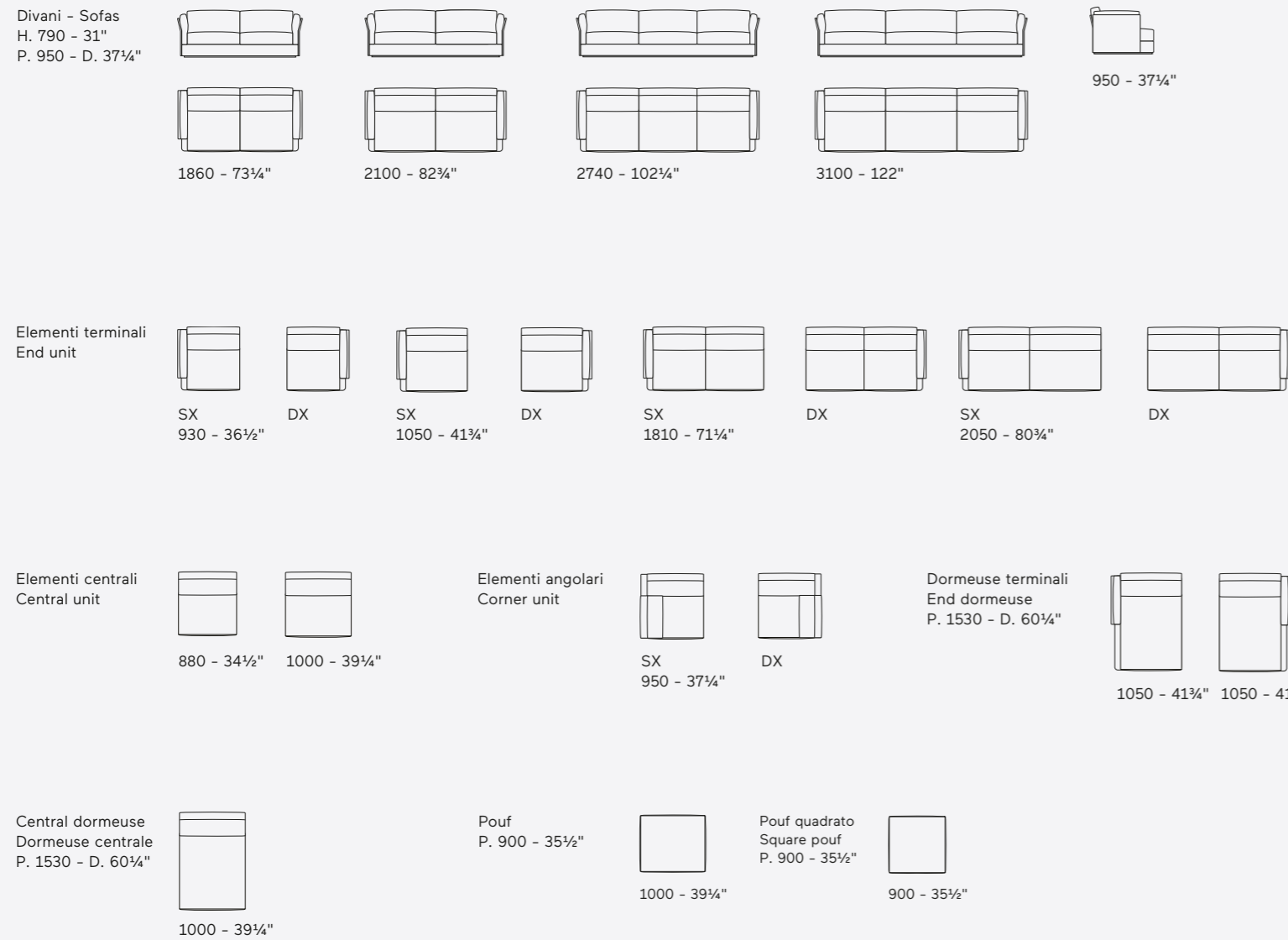

Jermyn – p. 90

Struttura: base in metallo e legno multistrati con cinghie elastiche incrociate. Braccioli e schienali in legno multistrati curvati. Imbottitura in poliuretano espanso a quote differenziate. Cuscini seduta: imbottitura in poliuretano espanso a quote differenziate con inserto di materiale viscoelastico (memory). Cuscini schienale: imbottitura in piuma d'oca canalizzata. Esecuzione: rivestimento tessuto/pelle sintetica/pelle. Sfoderabile in tessuto. Il rivestimento in pelle della struttura è fisso. I cuscini schienali sono sempre sfoderabili. Piedini in metallo verniciato bronzo M420.

Structure: base in metal and multiply wood with elastic webbing suspension. Arm and backrest in curved multiply wood. Padding in variable density, polyurethane foam. Seat cushions: padding in variable density, polyurethane foam with a visco-elastic memory foam insert. Backrest cushions: padding in channelled goose down. Finishing: fabric/synthetic leather/leather covering. Removable in fabric. The cover in leather for the structure is non-removable. The backrest cushions covers are removable, both fabric and leather. Feet in painted metal bronze M420.

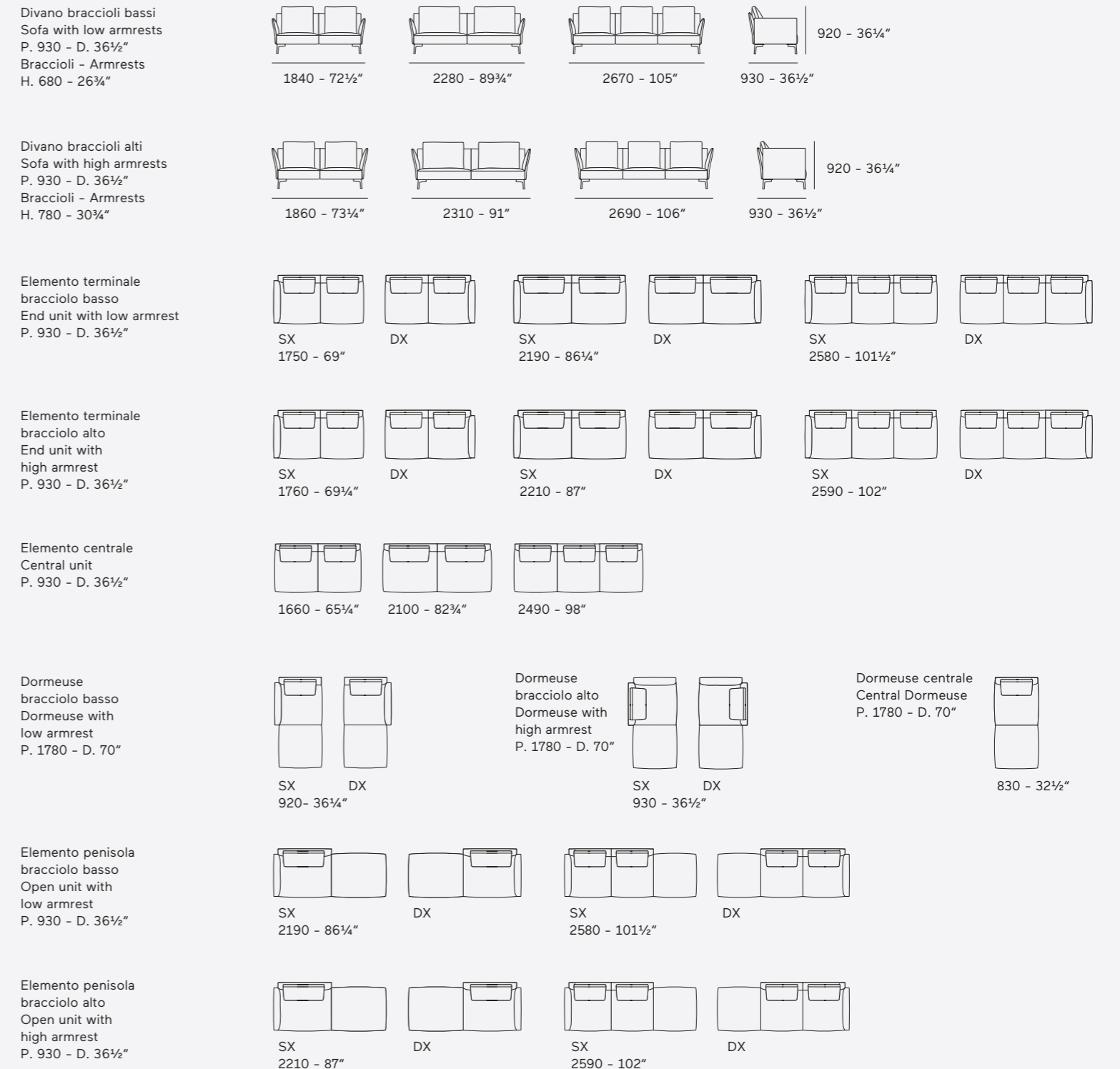

Jermyn – p. 90

Elemento penisola
Open unit
P. 930 - D. 36½"

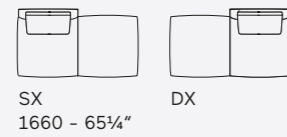

SX
1660 - 65¼"

DX

Pouf doppio
Double pouf
P. 820 - D. 32¼"

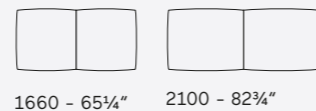

1660 - 65¼"

2100 - 82¾"

Divano braccioli bassi
Sofa with low armrests
P. 930 - D. 36½"

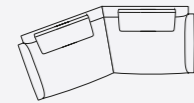

2540 - 100"

Divano braccioli alti
Sofa with high armrests
P. 930 - D. 36½"

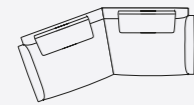

2540 - 100"

Elemento terminale
bracciolo basso
End unit with low armrest
P. 930 - D. 36½"

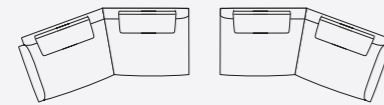

SX
2430 - 95½"

DX

Elemento terminale
bracciolo alto
End unit with high armrest
P. 930 - D. 36½"

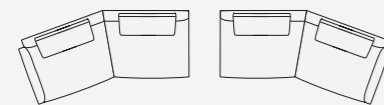

SX
2430 - 95½"

DX

Elemento centrale
Central unit
P. 930 - D. 36½"

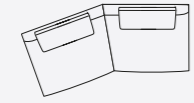

2370 - 93¼"

Elemento terminale
penisola bracciolo basso
Open end unit
with high armrest
P. 930 - D. 36½"



SX
2430 - 95½"

DX

Elemento terminale
penisola bracciolo alto
Open end unit
with high armrest
P. 930 - D. 36½"

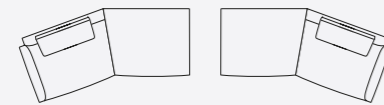

SX
2430 - 95½"

DX

Cuscino supplementare
Additional cushion



610 x 530
24" x 20¾"



790 x 530
31" x 20¾"



540 x 320
21¼" x 12½"

Kaiwa – p. 144

Struttura: in legno multistrati con cinghie elastiche. Schienale in POLIMEX®.
Imbottitura in poliuretano espanso a quote differenziate.
Cuscini seduta: imbottitura in poliuretano espanso a quote differenziate.
Rivestimento in tessuto, pelle sintetica, pelle. Sfoderabile. Base in metallo verniciato bronzo M420.

Structure: in multiply wood with elastic suspension. POLIMEX® backrest.
Padding in variable density, polyurethane foam.
Seat cushions: padding in variable density, polyurethane foam.
Finishing in fabric, synthetic leather, leather covering. Removable. Base in painted metal bronze M420.

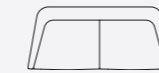

L. 1850 H. 700 - 625 P. 800
W. 72¾" H. 27½ - 24½" D. 31½"

Lennox – p. 140

Struttura: base in acciaio verniciato bronzo M420.
Imbottitura: scocca in baydur a spessori differenziati, schienale in poliuretano flessibile ad alta densità.
Rivestimento in fibra resinata accoppiato a tessuto velcrabile sfoderabile.

Structure: base in metal painted M420.
Padding: body in baydur with differentiated thicknesses, backrest in flexible high-density polyurethane.
Upholstery in resin-coated with fabric adhesive to velcro removable.



L. 1680 H. 690 P. 810
W. 66¼" H. 27¼" D. 32"

Mustique – p. 100

Struttura: base in metallo con cinghie elastiche incrociate. Braccioli e schienali in legno multistrati. Imbottitura in poliuretano espanso a quote differenziate con rivestimento in piuma d'oca canalizzata. Cuscini seduta: imbottitura in poliuretano espanso a quote differenziate e finitura della parte superiore in piuma d'oca canalizzata. Cuscini schienale: imbottitura in piuma d'oca canalizzata. Esecuzione: rivestimento tessuto, pelle sintetica, pelle. Sfoderabile in tessuto. Il rivestimento in pelle della struttura è fisso. I cuscini di seduta e schienali sono sempre sfoderabili. Piedini in metallo verniciato titanio M460.

Structure: base in metal with elastic suspension. Arm and backrest in multiply wood. Padding in variable density, polyurethane foam with section in channelled goose down. Seat cushions: padding in variable density, polyurethane foam and upper section in channelled goose down. Backrest cushions: padding in channelled goose down. Finishing: fabric, synthetic leather, leather covering. Removable in fabric. The cover in leather for the structure is non-removable. The seat and backrest cushions covers are removable, both fabric and leather. Feet in metal painted titanium M460.

Divano
Sofa
P. 1040 - D. 41"

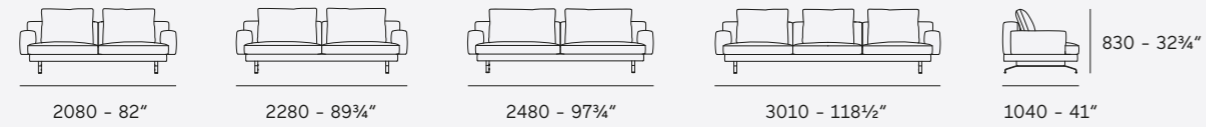

Elemento terminale
End unit
P. 1040 - D. 41"

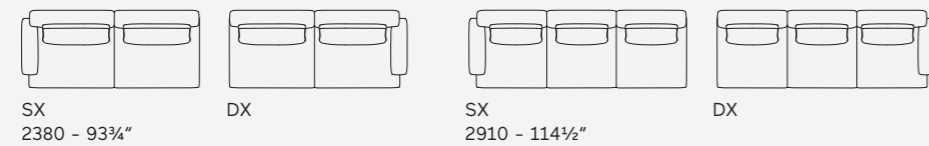
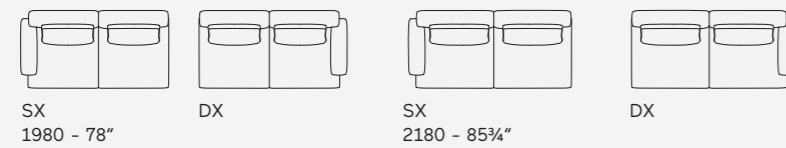

Elemento centrale
Central unit
P. 1040 - D. 41"

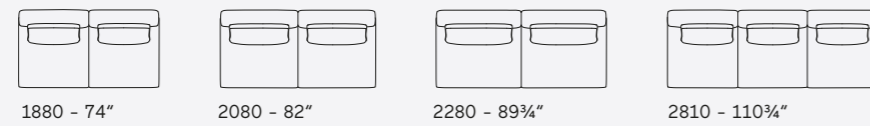

Angolare
Corner unit
P. 1040 - D. 41"

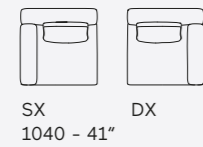

Dormeuse
P. 1500 - D. 59"

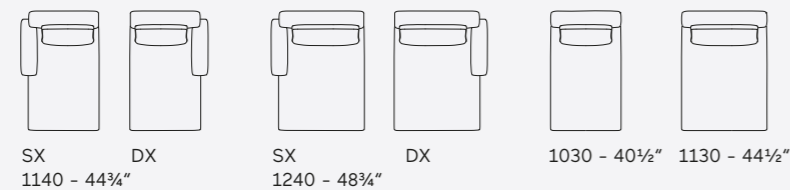

Pouf angolare
Corner pouf
P. 1040 - D. 41"

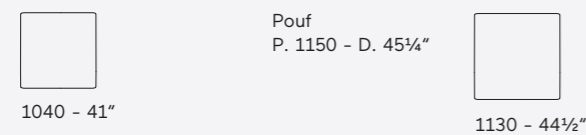

Cuscino
supplementare
Additional cushion

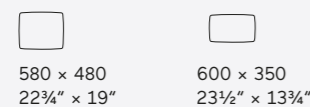

Neil – p. 110

Struttura: base in metallo con cinghie elastiche incrociate. Braccioli e schienali in legno multistrati. Imbottitura in poliuretano espanso a quote differenziate. Cuscini seduta: imbottitura in poliuretano espanso a quote differenziate. Esecuzione: rivestimento tessuto, pelle sintetica, pelle. Sfoderabile in tessuto. I cuscini di seduta sono sempre sfoderabili. Piedini in metallo verniciato bronzo M420.

Structure: base in metal with criss-crossed elastic straps. Armrests and backrest in plywood. Padding in variable density, polyurethane foam. Seat cushions: padding in variable density, polyurethane foam. Finishing: fabric, synthetic leather, leather covering. Removable in fabric. The seat cushions covers are removable, both fabric and leather. Feet in painted metal bronze M420.

Divano schienale basso
Sofa with low backrest
P. 950 - D. 37 1/2"

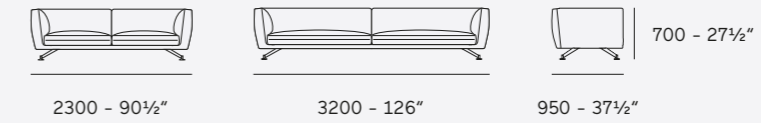

Divano schienale alto
Sofa with high backrest
P. 950 - D. 37 1/2"

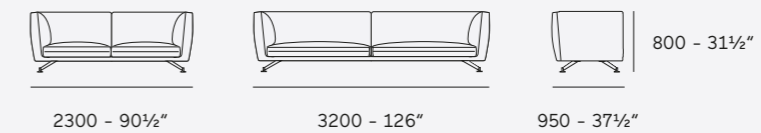

Elemento terminale
schienale basso
End unit with low backrest
P. 950 - D. 37 1/2"

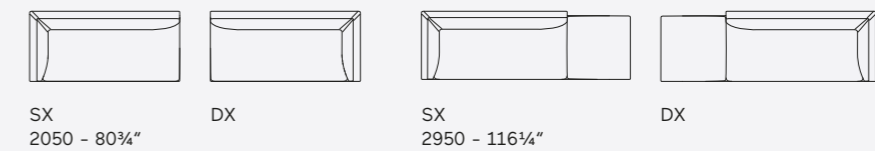

Elemento terminale
schienale alto
End unit with high backrest
P. 950 - D. 37 1/2"

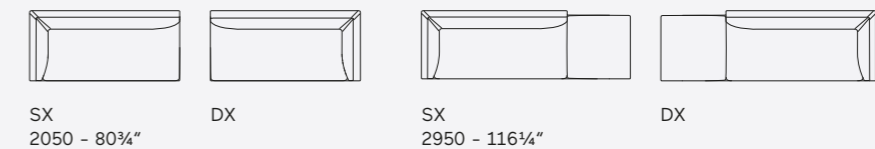

Dormeuse
schienale basso
Dormeuse with low backrest
P. 1700 - D. 67"

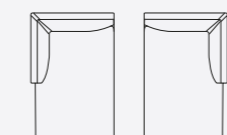

Dormeuse
schienale alto
Dormeuse with high backrest
P. 1700 - D. 67"

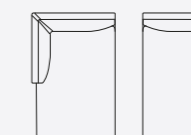

Elemento penisola
schienale alto
Dormeuse with high backrest
P. 950 - D. 37 1/2"

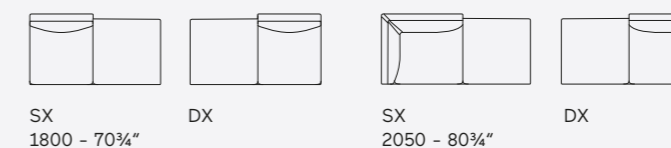

Elemento penisola
schienale basso
Open unit with low backrest
P. 950 - D. 37 1/2"

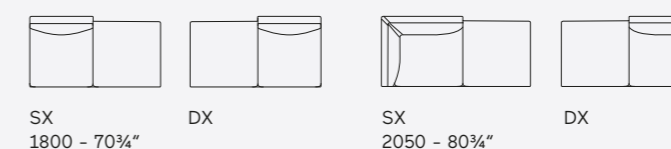

Cuscino
supplementare
Additional cushion
470 x 470
18 1/2" x 18 1/2"

600 x 320
23 1/2" x 12 1/2" 550 x 470
21 3/4" x 18 1/2"

Nella versione con schienali liberi così come in quella con schienali fissi, le molteplici facce di Niveaux creano composizioni sempre in grado di esprimere la personalità giovane e fresca del divano, capace di abitare la zona living con disinvoltura. Dal più contemporaneo al più classico, Niveaux crea infinite possibilità, grazie ai diversi moduli di seduta imbottiti quadrati, rettangolari e asimmetrici disponibili con tavolini d'appoggio, che si uniscono ad una serie di schienali e cuscini, e alle proposte di abbinamenti di materiali e texture ton sur ton.

In the version with moveable backs as well as in the one with fixed backs, the multiple styles of Niveaux create compositions that are able to express the youthful and new personality of the sofa, capable of being placed in any space. From the most modern to the most classic, Niveaux creates infinite possibilities, thanks to the different square, rectangular and asymmetrical upholstered seating modules available with side tables, which are combined with a series of backrests and cushions. The proposals include different combinations of fabrics and ton sur ton textures.

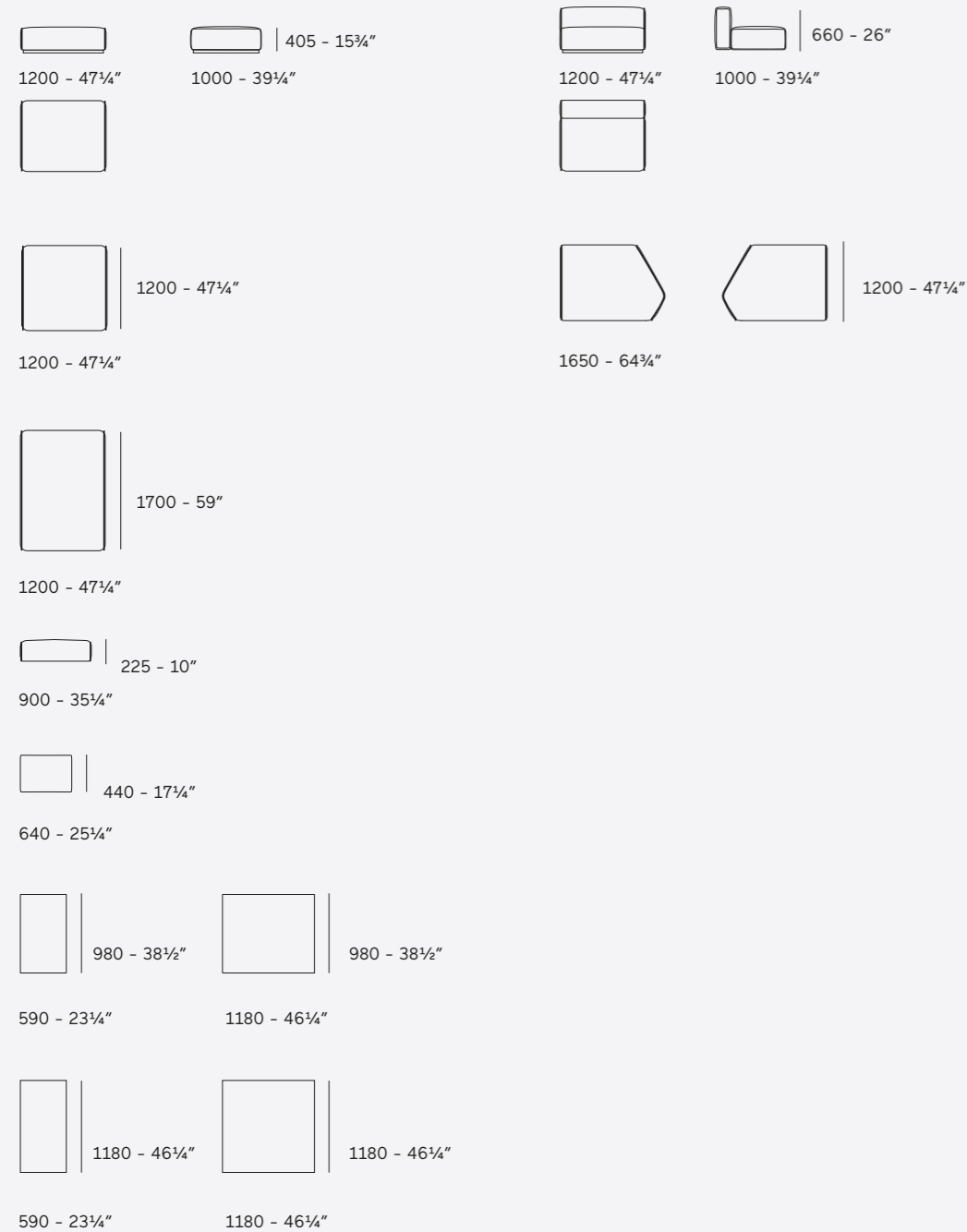

Struttura: base e schienale in legno massello e multistrati con molleggio garantito da cinghie elastiche. Imbottitura in poliuretano espanso a quote differenziate. Cuscini seduta: imbottitura in poliuretano espanso e finitura della parte superiore in High-tex, materiale innovativo ad alta tecnologia. Esecuzione: rivestimento tessuto, pelle sintetica, pelle. Sfoderabile in tessuto. Il rivestimento in pelle della struttura è fisso. I cuscini di seduta e schienali sono sempre sfoderabili. Piedini in legno massello o in alternativa in metallo cromo lucido o brunito.

Structure: base and backrest in solid wood and multiply wood with elastic webbing suspension. Padding in variable density, polyurethane foam. Seat cushions: padding in polyurethane foam and the upper portion in innovative High-tex quilt. Finishing: fabric, synthetic leather, leather covering. Removable in fabric. The cover in leather for the structure is non-removable. The seat and backrest cushions covers are removable, both fabric and leather. Feet in solid wood. Optional in glossy chromed metal or in burnished metal.

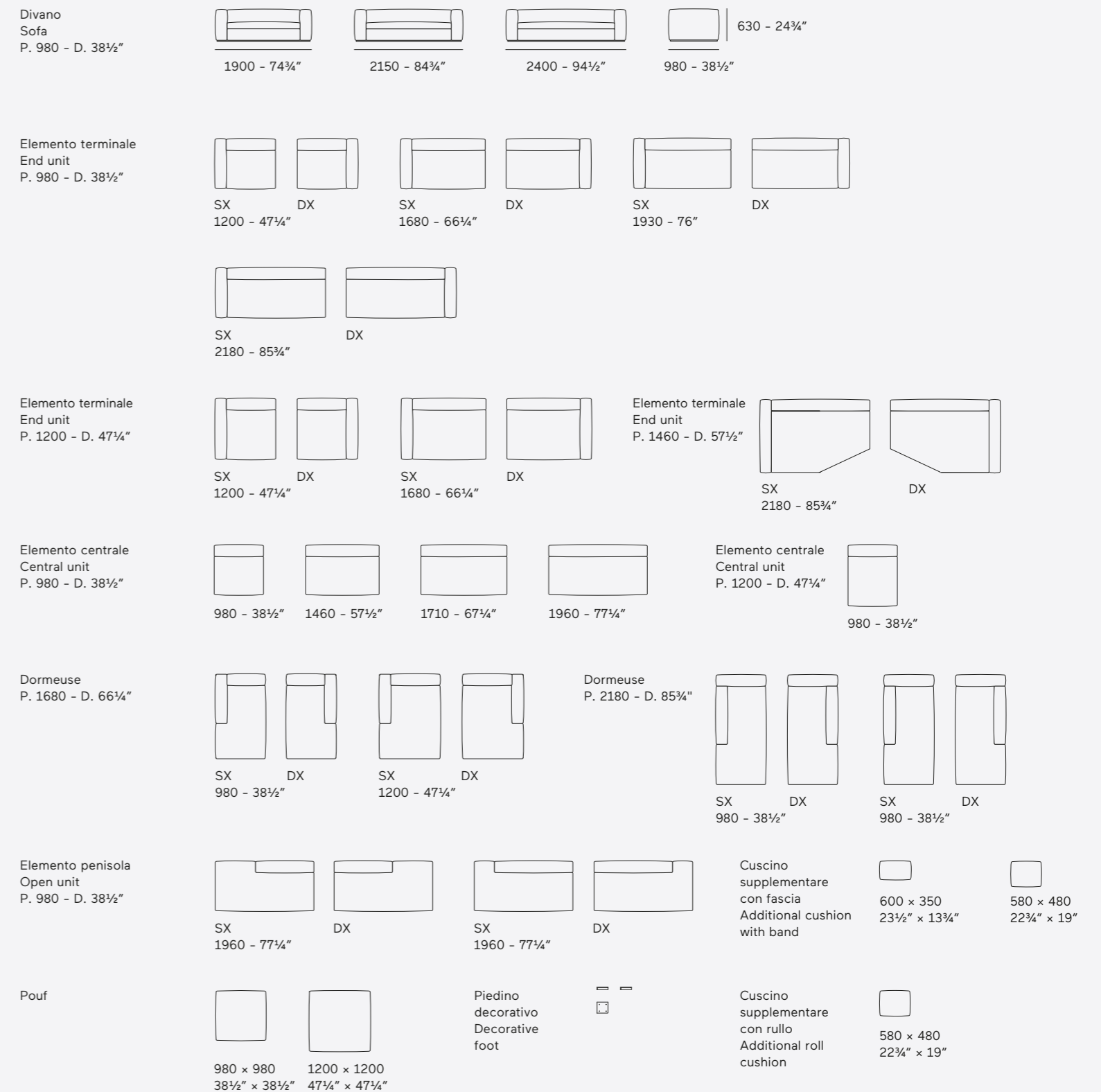

Taiki – p. 148

Struttura: telaio in legno massello tinto rovere termotrattato a geometria variabile. Base in legno multistrati. Braccioli e schienale con inserto in legno multistrati e cinghie elastiche. Imbottitura in poliuretano espanso a quote differenziate. Cuscini seduta: imbottitura in poliuretano espanso a quote differenziate. Rivestimento tessuto, pelle sintetica, pelle. Sfoderabile.

Structure: frame in heat-treated oak stained solid ash with variable geometry. Base in multiply wood. Armrests and backrest with insert in multiply wood and elastic suspension. Padding in variable density, polyurethane foam. Seat cushions: padding in variable density, polyurethane foam. Finishing in fabric, synthetic leather, leather covering. Removable.

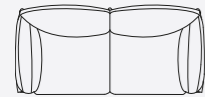

L. 1800 H. 700 P. 870
W. 70¾" H. 27½" D. 34¾"

Venise – p. 50

Struttura: base in legno massello e multistrati con molleggio garantito da cinghie elastiche. Imbottitura in poliuretano espanso a quote differenziate. Cuscini seduta: imbottitura in poliuretano espanso a quote differenziate. Cuscini schienale: imbottitura 33% piuma d'oca, 33% fibra, 34% chips poliuretano espanso canalizzati. Esecuzione: rivestimento tessuto, pelle sintetica, pelle. Sfoderabile in tessuto. Il rivestimento in pelle della struttura è fisso. I cuscini di seduta e schienali sono sempre sfoderabili. Piedini in legno massello verniciato.

Structure: base in solid wood and multiply wood with elastic webbing suspension. Padding in variable density, polyurethane foam. Seat cushions: padding in variable density, polyurethane foam. Backrest cushions: padding 33% goose down, 33% fibre, 34% channelled polyurethane foam chips. Finishing: fabric, synthetic leather, leather covering. Removable in fabric. The cover in leather for the structure is not removable. The seat and backrest cushions covers are removable, both fabric and leather. Feet in painted solid wood.

Divano braccioli alti
Sofa with high armrests
P. 1000 - D. 39¼"
Braccioli - Armrests
H. 630 - 24¾"

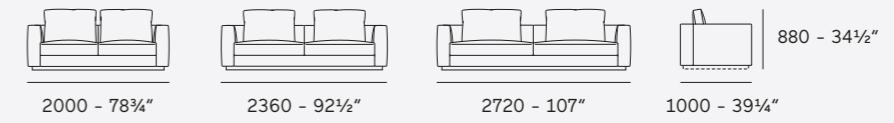

Divano braccioli bassi
Sofa with low armrests
P. 1000 - D. 39¼"
Braccioli - Armrests
H. 530 - 20¾"

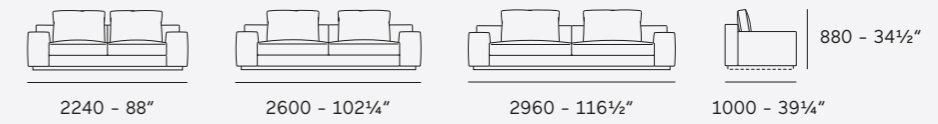

Elemento terminale
bracciolo alto
End unit high armrest
P. 1000 - D. 39¼"

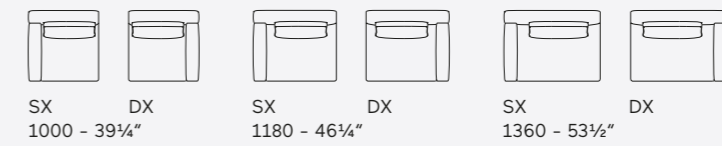

*Terminale o angolare
*End/corner

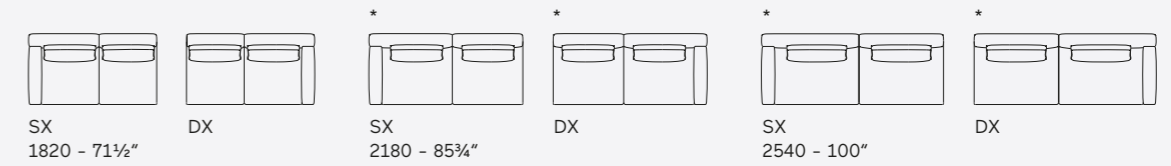

Elemento terminale
trapezio bracciolo alto
Trapezium end unit
high armrest
P. 1000 - D. 39¼"

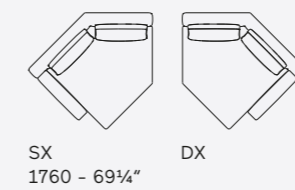

Elemento terminale
curvilineo
bracciolo alto
Curved end unit
high armrest
P. 1000 - D. 39¼"

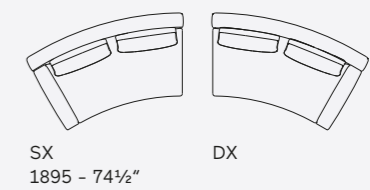

Elemento terminale goccia
schienale alto
Drop-shaped end unit
high backrest
P. 1000 - D. 39¼"

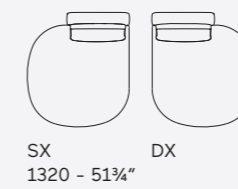

Elemento terminale
bracciolo basso
End unit low armrest
P. 1000 - D. 39¼"

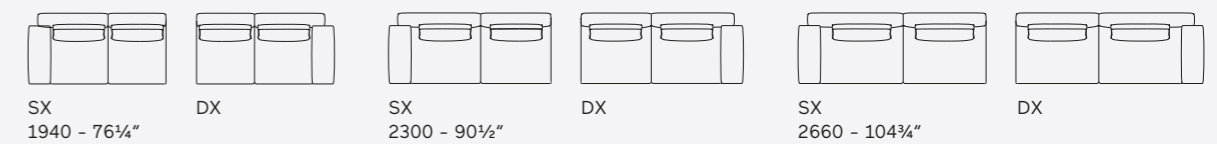

Venise – p. 50

Elemento terminale
trapezio
bracciolo basso
Trapezium end unit
low armrest depth
P. 1000 - D. 39¼"

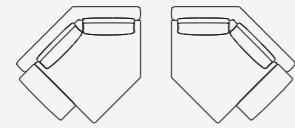

SX
1760 - 69¼"

DX

Elemento terminale
curvilineo
bracciolo basso
Curved end unit
low armrest depth
P. 1000 - D. 39¼"

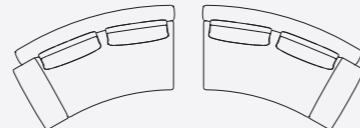

SX
1900 - 74¼"

DX

Elemento centrale
Central unit
P. 1000 - D. 39¼"



820 - 32¼"

1000 - 39¼"

1180 - 46¼"

1640 - 64½"

2000 - 78¼"

2360 - 92½"

Elemento centrale trapezio
Trapezium central unit
P. 1000 - D. 39¼"

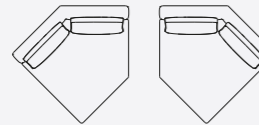

SX
1640 - 64½"

DX

Elemento centrale
curvilineo
Curved central unit
P. 1000 - D. 39¼"



1750 - 68¼"

Elemento angolare
Corner unit
45°/90°
P. 1000 - D. 39¼"



1820 - 71½"

Dormeuse terminale
bracciolo alto
End dormeuse
high armrest
P. 1360 - D. 53½"

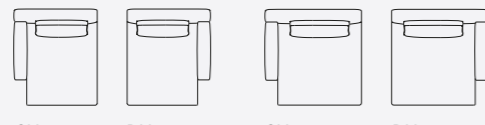

SX
1180 - 46¼"

DX

SX
1360 - 53½"

DX

Dormeuse terminale
bracciolo alto
End dormeuse
high armrest
P. 1700 - D. 66¾"

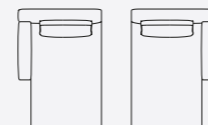

SX
1180 - 46¼"

DX

Dormeuse terminale
bracciolo basso
End dormeuse
low armrest
P. 1360 - D. 53½"

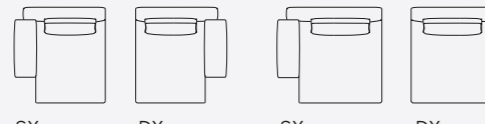

SX
1300 - 51"

DX

SX
1480 - 58¼"

DX

Dormeuse terminale
bracciolo basso
End dormeuse
low armrest
P. 1700 - D. 66¾"

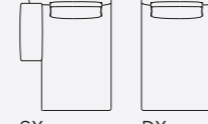

SX
1300 - 51"

DX

Dormeuse centrale
Central dormeuse
P. 1360 - D. 53½"

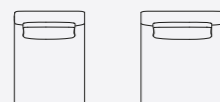

1000 - 39¼"

1180 - 46¼"

Dormeuse goccia
bracciolo alto
Drop-shaped end unit
high armrest
P. 1500 - D. 59¼"

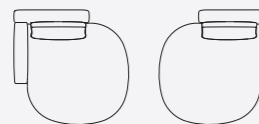

SX
1500 - 59¼"

DX

Dormeuse goccia
bracciolo basso
Drop-shaped end unit
low armrest
P. 1500 - D. 59¼"

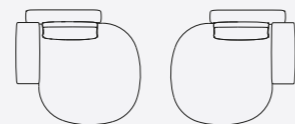

SX
1620 - 63¼"

DX

Pouf angolare
Corner pouf
P. 1000 - D. 39¼"



1000 - 39¼"

Pouf
P. 1360 - D. 53½"



1000 - 39¼"

Pouf
P. 1000 - D. 39¼"



820 - 32¼"

Pouf goccia
Drop shaped pouf
P. 820-32 - D. 53½"



1320 - 51¼"

Cuscino supplementare
Additional cushion



580 x 480
22¾" x 19"



700 x 500
27½" x 19½"



800 x 500
31½" x 19½"

Yard – p. 128

Struttura: base, braccioli e schienali in metallo con cinghie elastiche incrociate.
Imbottitura in poliuretano espanso a quote differenziate. Cuscini seduta: imbottitura in poliuretano espanso a quote differenziate e finitura della parte superiore in piuma d'oca canalizzata. Esecuzione: rivestimento tessuto, pelle sintetica, pelle. Sfoderabile in tessuto. Il rivestimento in pelle della struttura è fisso. I cuscini di seduta sono sempre sfoderabili. Piedini in metallo verniciato bronzo M420.

Structure: base, armrests and backrests in metal with elastic suspension. Padding in variable density, polyurethane foam. Seat cushions: padding in variable density, polyurethane foam and upper section in channelled goose down. Finishing: fabric, synthetic leather, leather covering. Removable in fabric. The cover in leather for the structure is non-removable. The seat cushions covers are removable, both fabric and leather. Feet in painted metal bronze M420.

Divano
Sofa
P. 1000 - D. 39¼"



2040 - 80¼"

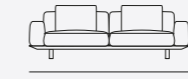

2240 - 88½"

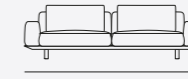

2440 - 96"

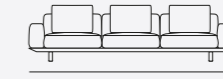

2840 - 111¼"



1000 - 39¼"

Divano
Sofa
P. 1000 - D. 39¼"

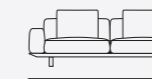

3140 - 123½"



3240 - 127½"

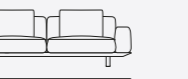

3240 - 127½"

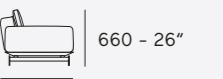
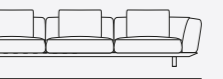

1000 - 39¼"

Elemento terminale
End unit
P. 1000 - D. 39¼"



SX
1820 - 71¼"



DX



SX
2020 - 79½"

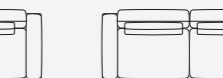

DX

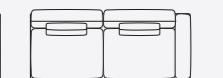

SX
2220 - 87½"

DX

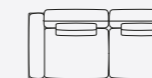

SX
2920 - 115"



DX



SX
2920 - 115"



DX

Elemento centrale
Central unit
P. 1000 - D. 39¼"



1600 - 63"

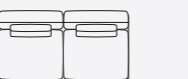

1800 - 70¼"



2000 - 78¼"



2700 - 106½"

Elemento angolare
Corner unit
P. 1000 - D. 39¼"

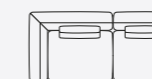

SX
2120 - 83½"



DX



SX
3020 - 119"



DX

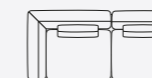

SX
3020 - 119"



Dormeuse
P. 1600 - D. 63"

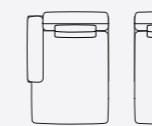

SX
1120 - 44"

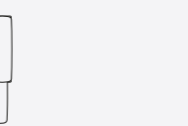

DX

Yard – p. 128

Elemento penisola
Open unit
P. 1000 - D. 39¼"

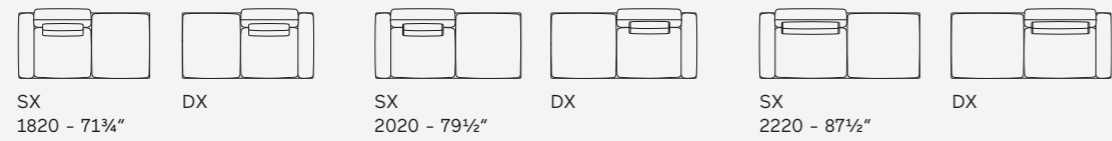
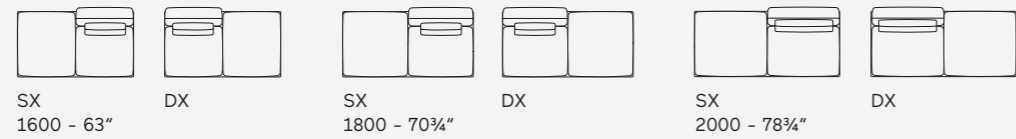

Elemento terminale
con vano predisposto
per codice RP090
End unit with space
arranged for code RP090
P. 1000 - D. 39¼"

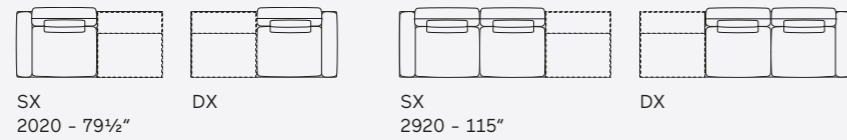

Elemento centrale
con vano predisposto
per codice RP090
Central unit with space
arranged for code RP090
P. 1000 - D. 39¼"

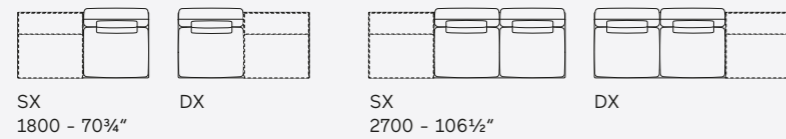

Elemento angolare
con vano predisposto
per codice RP090
Central unit with space
arranged for code RP090
P. 1000 - D. 39¼"

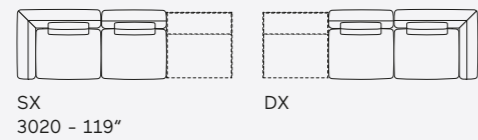

Yard Daybed
P. 910 - D. 35¼"

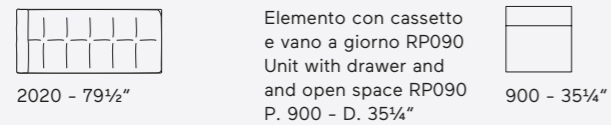

Cuscino supplementare
Additional cushion

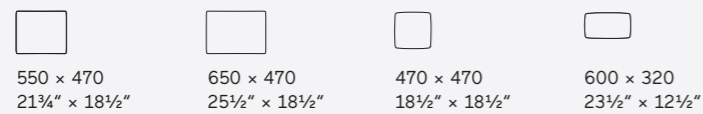

Mensola divano Yard
Yard sofa shelf

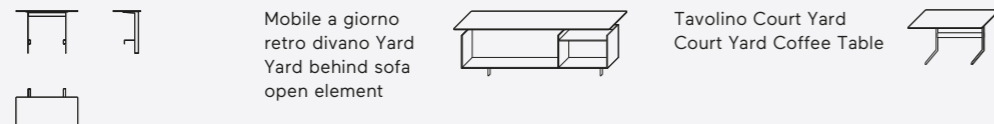

Yaki – p. 152

Struttura: pannello composto da particelle di legno. Imbottitura in poliuretano espanso a quote differenziate. Cuscini seduta: imbottitura in poliuretano espanso a quote differenziate. Cuscini schienale: telaio in metallo con tasca per contenimento guanciaie. Imbottitura in poliuretano espanso a quote differenziate Rete: struttura portante in acciaio, doppia serie di doghe in largo calibro e intreccio di cinghie elastiche per garantire un elevato comfort. Materasso: appositamente studiato per queste tipologie di prodotto. La sua struttura è costituita da un monoblocco di poliuretano espanso indeformabile ad alta densità. Esecuzione: rivestimento tessuto, pelle sintetica, pelle. Sfoderabile in tessuto. Il rivestimento in pelle della struttura è fisso. I cuscini di seduta e schienali sono sempre sfoderabili.

Structure: panel composed of wood particles. Padding in variable density, polyurethane foam. Seat cushions: padding in variable density, polyurethane foam. Backrest cushions: metal frame with pocket for pillows. Padding in variable density, polyurethane foam. Bed frame: structure in high resistance steel, double series of wide calibre slats and criss-crossed reinforced elastic bands for the comfort. Mattress: specifically studied for these types of products. Its frame is constituted of a monobloc of high density non-deformable polyurethane foam. Finishing: fabric, synthetic leather, leather covering. Removable in fabric. The cover in leather for the structure is non-removable. The seat and backrest cushions covers are removable, both fabric and leather.

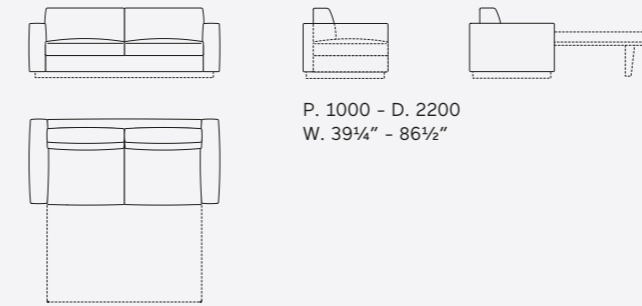

L. 2050 - 2250 - 2450 H. 820 P. 2200
W. 80¾" - 88½" - 96¼" H. 32¼" D. 86½"

Armchairs

Aberdeen – p. 68

Poltrona sfoderabile. Rivestimento in tessuto Aberdeen. Disponibile con ruote in acciaio rivestite in gomma o con piedini in legno massello verniciato.

Removable armchair. Aberdeen fabric collection covering. Available with metal wheels rubber-coated or with feet in painted solid wood.



L. 1050 H. 660 P. 1010
W. 41¾" H. 26" D. 39¾"

Alton – p. 172

Struttura in metallo verniciato nero M440. Schienale intrecciato cuoio naturale o intrecciato cotone cerato testa di moro. Seduta con rivestimento tessuto, pelle sintetica, pelle. Sfoderabile. Cuscino schienale opzionale in tessuto, pelle sintetica e pelle.



L. 1030 H. 635 P. 785
W. 40½" H. 25" D. 31"

Structure finishing in M440 black painted metal. Backrest in natural hide braided or waxed cotton dark brown hide braided. Seat with fabric, synthetic leather, leather covering. Removable. Optional backrest cushion in fabric, synthetic leather, leather.

Eydo – p. 184

Struttura in metallo verniciato bronzo M420. Seduta, schienale in rivestimento pelle super, pelle top. Non sfoderabile.



L. 1610 H. 880 P. 760
W. 63½" H. 34¾" D. 30"

Structure finishing in M420 bronze painted metal. Seat, backrest finishing in leather super, leather top covering. Not removable.

Bice – p. 180

Struttura in metallo verniciato bronzo M420. Seduta e schienale con rivestimento in tessuto, pelle sintetica, pelle. Non sfoderabile.



L. 710 H. 720 P. 700
W. 28" H. 28¼" D. 27½"

Structure finishing in M420 metal painted bronze M420. Seat and backrest: in fabric, synthetic leather, leather covering. Not removable.

Fantino – p. 186

Struttura in frassino tinto rovere termotrattato. Seduta/schiena in rivestimento tessuto, pelle sintetica, pelle. Sfoderabile solo in tessuto. È possibile scegliere fra 2 tipologie di rivestimento sia che si tratti di tessuto o di pelle: con cucitura standard o con gros grain.



L. 700 H. 830 P. 790
W. 27½" H. 32¾" D. 31"

Structure finishing in heat-treated oak stained ash. Seat, backrest finishing in fabric synthetic leather, leather covering. Only the fabric lining is removable. It's possible to choose between 2 types of covering whether it would be fabric or leather: with standard seam or with gros grain.

Claire – p. 162

Caratterizzata dallo schienale alto e dalla forma arrotondata, la lounge chair Claire invita a sedersi comodamente concedendosi un momento di relax. In contrasto con la generosa imbottitura, la struttura realizzata in metallo risulta essenziale, impreziosita da braccioli in legno massello che aggiungono una rassicurante tattilità all'intera poltrona. Attraverso questi ricercati dettagli e un'attenta sperimentazione tra proporzioni e volumi, Norm Architects ha voluto dare vita ad una lounge classica per un abitare contemporaneo.



L. 785 H. 1000 P. 870
W. 31" H. 39¾" D. 34¾"

Featuring a high backrest and rounded shape, the Claire lounge chair invites you to sit comfortably, while enjoying a moment of relaxation. In contrast to the generous upholstery, the metal frame is minimalist, enhanced by solid wood armrests that give the entire armchair a reassuring tactility. Through these sophisticated details and careful experimentation with proportions and volumes, Norm Architects has sought to create a classic lounge for contemporary living.

Felix – p. 188

Rivestimento in tessuto, pelle sintetica, pelle. Non sfoderabile. Disponibile con cucitura standard o con gros grain.



L. 750 H. 710 P. 790
W. 29½" H. 28" D. 31"

Covering in fabric, synthetic leather, leather. Not removable. Available with standard seam or with gros grain.

Lady Jane + Pouf – p. 190

Struttura in metallo verniciato bronzo M420. Seduta e schienale in rivestimento tessuto o pelle. Sfoderabile solo in tessuto. Non realizzabile in velluto. Disponibile con o senza base girevole.

Pouf con struttura in metallo verniciato bronzo M420. Rivestimento tessuto o pelle. Sfoderabile solo in tessuto. Non realizzabile in velluto.



L. 755 H. 900 P. 915
W. 29¾" H. 35½" D. 36"



L. 590 H. 400 P. 590
W. 23¾" H. 15¾" D. 23¾"

Structure finishing: M440 bronze painted metal. Seat and backrest: fabric or leather covering. Only the fabric lining is removable. Not possible in velvet. Available with or without revolving base.

Pouf: structure finishing M440 bronze painted metal. Fabric or leather covering. Only the fabric lining is removable. Not possible in velvet.

Maddix – p. 158

Struttura in massello di frassino tinto rovere termotrattato. Sottoscocca in cuoio light caffè 19. Seduta e schienale in rivestimento tessuto, pelle sintetica, pelle. Sfoderabile.



L. 780 H. 730 P. 850
W. 30½" H. 28¾" D. 33½"

Structure finishing in heat-treated oak stained solid ash. Underbody finishing in light hide caffè 19. Seat and backrest finishing in fabric, synthetic leather, leather covering. Removable.

Lennox + Pouf – p. 194

Struttura in metallo verniciato bronzo M420. Seduta e schienale rivestimento tessuto, pelle sintetica, pelle. Sfoderabile.

Pouf con struttura in metallo verniciato bronzo M420. Rivestimento in tessuto, pelle sintetica, pelle. Sfoderabile.



L. 1040 H. 690 P. 810
W. 41" H. 27¼" D. 32"



L. 630 H. 400 P. 480
W. 24¾" H. 15¾" D. 19"

Structure finishing in M420 bronze painted metal. Seat and backrest in fabric, synthetic leather, leather covering. Removable.

Pouf in structure finishing M420 bronze painted metal. Fabric, synthetic leather, leather covering. Removable.

Popsi – p. 198

Struttura in metallo cromato M200 o metallo verniciato nero M440. Seduta e schienale in cuoio.



L. 678 H. 690 P. 725
W. 26¾" H. 27¼" D. 28½"

Structure finishing in M200 chromed metal or M440 black painted metal. Seat and backrest in hide finishing.

Lucylle – p. 164

Struttura in massello di frassino tinto rovere termotrattato. Seduta e schienale con rivestimento tessuto, pelle sintetica, pelle. Non sfoderabile.



L. 700 H. 750 P. 720
W. 27½" H. 29½" D. 28¾"

Structure finishing in heat-treated oak stained solid ash. Seat and backrest with fabric, synthetic eather, leather covering. Not removable.

Taiki – p. 200

Struttura in massello di frassino tinto rovere termotrattato. Seduta e schienale con rivestimento in tessuto, pelle sintetica, pelle. Sfoderabile.



L. 960 H. 700 P. 870
W. 37¾" H. 27½" D. 34¾"

Structure finishing in heat-treated oak stained solid ash. Seat and backrest finishing with fabric, synthetic leather, leather covering. Removable.

Tarsia – p. 168

Struttura in massello di frassino tinto rovere termotrattato. Seduta e schienale: rivestimento tessuto, pelle sintetica, pelle. Sfoderabile. Disponibile nella versione plain o stripe con cuciture verticali.

Structure finishing in heat-treated oak stained solid ash. Seat and backrest finishing: fabric, synthetic leather, leather covering. Removable. Plain version or stripe version with vertical stitching available.



L. 850 H. 750 P. 850
W. 33½" H. 29½" D. 33½"

Yard Daybed – p. 204

Struttura in metallo verniciato bronzo M420. Seduta con rivestimento in tessuto, pelle sintetica, pelle. Con cuscino a rullo.

Structure finishing in M420 bronze painted metal. Seat finishing: in fabric, synthetic leather, leather covering. With roll cushion.

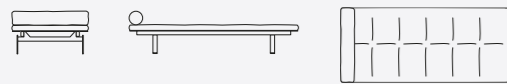

L. 910 H. 335 P. 2020
W. 35¾" H. 15¼" D. 79½"

Poufs

Aley – p. 210

Esecuzione: rivestimento tessuto, pelle sintetica, pelle. Sfoderabile. Imbottito, con cuciture e elemento di chiusura decorativo centrale. Disponibile ovale o tondo.

Finishing: fabric, synthetic leather, leather covering. Removable. Padded, with stitching and central decorative closure part. Available oval and round.

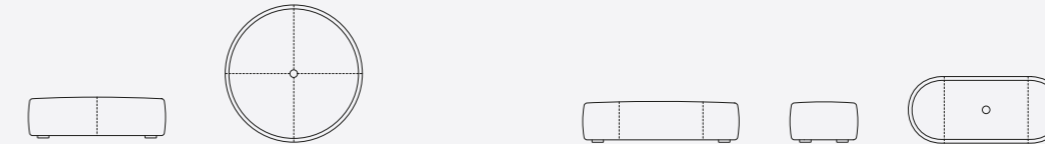

Ø 1440 H. 430
Ø 56½" H. 17"

L. 1640 H. 430 P. 700
W. 64½" H. 17" D. 27½"

Notch – p. 214

Esecuzione: rivestimento tessuto, pelle sintetica, pelle. Sfoderabile. Con maniglie in cuoio naturale invecchiato. Disponibile in 2 misure.

Finishing: fabric, synthetic leather, leather covering. Removable. With handles in aged natural hide. Available in 2 sizes.



Ø 550 H. 430
Ø 21¾" H. 17"

Ø 850 H. 400
Ø 33½" H. 15¾"

Pouf – p. 216

Esecuzione: rivestimento tessuto, pelle sintetica, pelle, cavallino (pezzato 3 colori marrone, nero, bianco). Sfoderabile. Disponibile quadrato e tondo.

Finishing: fabric, synthetic leather, leather, spotted leather (pied in 3 colours brown, black, white) covering. Removable. Available square and round.



L. 460 H. 400 P. 460
W. 18" H. 15¾" D. 18"

Ø 580 H. 320
Ø 22¾" H. 12½"

Tod – p. 218

Disponibile solo in pelle TOP nei colori: PT0013/PT0014 non sfoderabile.
Disponibile in 2 misure.

Available only in leather TOP in the following colours: PT0013/PT0014
not removable. Available in 2 sizes.

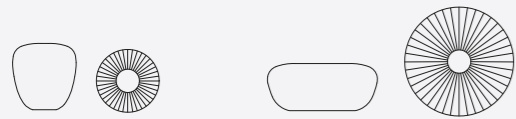

Ø 520 H. 550
Ø 20½" H. 21¾"

Ø 900 H. 390
Ø 35½" H. 15¼"

Benches

Fence – p. 226

Struttura in metallo bronzato con sali di selenio. Piano in noce canaletto.

Structure finishing: in selenium salts bronzed metal. Top finishing: canaletto walnut.



L. 1600 H. 370 P. 420
W. 63" H. 14½" D. 16½"

Uma – p. 220

Struttura in metallo verniciato bronzo M420. Vassoio in rovere termotrattato.
Cuscini in rivestimento pelle sintetica, pelle. Non sfoderabile.

Structure finishing in M420 bronze painted metal. Tray finishing in heat-treated oak.
Cushions finishing in synthetic leather, leather covering. Not removable.

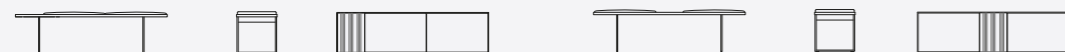

L. 1500 H. 430 P. 400
W. 59" H. 17" D. 15¾"

L. 1500 H. 430 P. 400
W. 59" H. 17" D. 15¾"

**Project
Photo
Styling**

**Text
Translation
Repro+Print**

**Lissoni Graphx
Santi Caleca, Thomas Pagani
Studio Salaris, Ufficio Stile Lema,
Patrizia Cantarella
R+W
Lema
Ogm, 2023**

Thanks to

Amini Carpets
Altai
Artemide
Besana Carpet Lab
Cc Tapis
Ceramiche Milesi
Expat
Fabrica
Fontana Arte
Giopato & Coombes
Giorgio Bonaguro
Golran
Gt Design
I+I
Ilaria Franza Painting
Fanale
Incipit Lab
L'Arte nel Pozzo
Luceplan
MM Lampadari
Nemolighting
Next Materials
Oluce
Paola Paronetto
Penta Light
Portego
Scandola Marmi
Segno Italiano
Sklo Studio
Society by Limonta
Vistosi
Zava

关注LEMA微信公众号
Follow LEMA WeChat account



公众号 ID : LemaOfficial

Lema S.p.a.
22040 Alzate Brianza
Como – Italia
Strada Statale
Briantea N° 2
T. +39 031 630 990
lemamobili.com